

**Department of Executive Services  
Facilities Management Division**

King County Courthouse South Entrance Renovation Report

King County Ordinance 15333, Section 114

November 2007

## Executive Summary

In August of 2006, the King County Council adopted Ordinance 15333. Ordinance 15333 requires a study and review of design options and operations changes for a potential renovation and reopening of the south entrance to the King County Courthouse (KCC). This report identifies the costs and logistical changes of relocating the Courthouse entrance to the historical south entry in conjunction with closure of the current entrances on Third Avenue and Fourth Avenues.

Ordinance 15333, Section 114 identified four specific areas of concern to be addressed within the report:

- “A detailed security staffing and operations evaluation is needed to determine final costs and savings opportunities”;<sup>1</sup>
- “A study of public use and the impacts to public access of both the reopened south entrance and the potential closure of the east and west entrances is needed”;<sup>2</sup>
- “Outreach and consultation with all of these groups and the public is needed prior to any final decision about the reopening the south entrance and closing the east and west entrances”;<sup>3</sup> and
- “A detailed study of the identified issues of funding, debt capacity, security and operational impact and access to the courthouse by all branches of King County government and their employees, jurors and the general public is concluded and adopted by the council.”<sup>4</sup>

The initial design concept prepared by FMD provided for two screening stations at the renovated south entrance, in concert with closing the Third and Fourth Avenue entrances. The Third and Fourth Avenue doorways would become exit only. The King County Office of Management and Budget (OMB) evaluated this configuration in a 2007 study of the pedestrian traffic utilization of the three existing entrances to the KCC (currently Third Avenue, Fourth Avenue, and the tunnel from the King County Administration Building).

### Courthouse Utilization Study

The utilization study results indicated two critical factors in a South Entrance renovation:

- A loss in the present number of street-level screening stations (three) could result in significant lines during peak entry times, and

---

<sup>1</sup> Ordinance 15333, Section 114 at Paragraph F.

<sup>2</sup> Id., at Paragraph G.

<sup>3</sup> Id., at Paragraph H.

<sup>4</sup> Id., at Paragraph I.

- Reconfiguration of the current entrances on Third and Fourth Avenues presents potential additional operational costs if court deputies must monitor the exits.

Following review of OMB's utilization study, FMD and King County Sheriff's Office (KCSO) developed an entryway configuration that accommodates three screening stations in the South entrance. Under this configuration, no net loss of the present number of screening stations occurs. Potential operational cost savings resulting from a reduction of the total number of screeners needed to monitor the screening stations is maximized under this configuration. The utilization study is included as **Appendix A** to this report. A diagram of the south entryway featuring three screening stations is included within **Appendix E**.

#### Staffing and Operations Changes

The KCSO staffing options included in the OMB pedestrian study present alternatives regarding staffing at the Third and Fourth Avenue exits. The Department of Executive Services, Facilities Management Division (FMD) has identified a "sallyport" door that could prevent re-entry into the Courthouse by exiting patrons. However, KCSO staff recommend additional court deputies to monitor these exits. The addition of these staff presents an operational fiscal impact greater than present-day operational costs, independent of other changes. Given these costs, other potential monitoring options (cameras, re-entry alarms, etc.) should be considered for further study.

#### Loading Dock Alternatives

The KCC loading dock is currently open eight hours a day. The OMB utilization study observed that the use of the loading dock is minimal. Eliminating the loading dock presents potentially significant cost savings in project capital costs and in ongoing operations costs (due to the lack of need for security personnel dedicated to the loading dock). FMD has provided project cost estimates that both provide for a new KCC loading dock and another eliminating the present loading dock without replacement. Total project costs with the inclusion of a new loading dock facility are \$16,800,000 (see Option 3). Total project costs without a new loading dock are \$8,500,000 (see Option 2).

This report contains the response to the study items identified within Ordinance 15333, Section 114:

**Appendix A**, the utilization study prepared by OMB, addresses the items called out in Ordinance 15333, Section 114 Paragraphs F. and G. regarding public access to the King County Courthouse and the evaluation of changes to security staffing and operations resulting for a renovated and relocated South entrance.

**Appendix B** contains a report summarizing the outreach to principal user groups of the Courthouse and their responses, as requested in paragraph H.

**Appendix C** contains life cycle cost analyses of the present project cost for a renovated south entry with and without a new loading dock underneath City Hall park. Together with the utilization study, these analyses provide the financial data called for in paragraph I.

**Appendix D** contains the Conceptual Design Estimate Summary prepared by consultants The Robinson Company, and CIP Project Cost Estimate Summaries for project costs with and without construction of a new loading dock.

**Appendix E** contains examples of the “sallyport” exit doors for the current Third and Fourth Avenue entrances and other design development drawings for the project to date.

## A. King County Courthouse Utilization Study

In 2007, the King County Office of Management and Budget conducted a study of the pedestrian utilization of the three existing entrances to the King County Courthouse, and the potential changes to pedestrian traffic and security staffing and operations resulting from a relocation of the entrance to the south side of the building. From this, OMB extrapolated the effect on KCSO security staffing levels in four potential options. The lowest cost option resulted in \$265,000 in annual savings in operations costs. The highest cost option resulted in an additional \$123,000 in operations costs.

### a. Utilization Study Findings Regarding Pedestrian Access and Public Use Impacts

There are four screening stations at the Courthouse entrances: two at the Third Avenue entrance, and one each at the Fourth Avenue and tunnel<sup>5</sup> entrances. The utilization study observed the average hourly pedestrian traffic at each of the three Courthouse entrances and the loading dock, resulting in six findings:

- Pedestrian traffic flows in a predictable pattern with peaks between 8:00 and 9:00 A.M. and 12:30 and 1:30 P.M.
- Queues longer than 10 persons are directly related to the pedestrian traffic flow.
- Different scenarios exist regarding the level of use of the tunnel entrance if the Third and Fourth Avenue entrances are closed in favor of a new south entrance.
- The likelihood of long lines forming increases exponentially if the total number of screening stations is reduced below four.
- Four screening stations are required to meet peak pedestrian traffic flows.
- The loading dock is underutilized and should be considered for elimination.

### b. South Entrance Configuration

FMD recently developed an entryway configuration that accommodates three screening stations in the South entrance. This configuration would maximize the potential savings that result from a reduction of the total number of screeners needed to monitor the Courthouse screening stations by allowing closure of the Third and Fourth Avenue entrances. In addition, limiting the street ingress to the south entrance maximizes the objectives in revitalizing the area of City Hall Park, by coordinating pedestrian traffic through the park into a single street level entry.

### c. Staffing Needs for Entrance Alternatives

Currently, 16 screeners and 5 deputy sheriffs are needed to staff the Courthouse entrances. If the total number of entrances is reduced, efficiencies can be achieved through a reduction in screening station hours. However, there could be a need for additional security staff at the closed 3<sup>rd</sup> and 4<sup>th</sup> Avenue exits.

---

<sup>5</sup> The tunnel entrance is located in the basement of the King County Administration Building, screening access to the tunnel connecting the King County Courthouse from the Administration Building.

The utilization study produced four options for staffing the reconfigured South Entrance. The operational fiscal impact of each of the options within the utilization study highlights two major cost factors:

- **Security Levels:** The need for additional security has the greatest impact on operational costs. The Sheriff's Office recommends posting staff at the 3<sup>rd</sup> and 4<sup>th</sup> Avenue exits. Alternatively, capital equipment (e.g. sallyport doors with security cameras, alarms, etc.) could be installed in lieu of stationed personnel.
- **Loading Dock Hours:** The hours of loading dock could also impact operational costs. If the loading dock is eliminated, there could be additional savings in staffing costs.

**Table 1. Operational Security Staffing Options**

	<b>Current Staffing</b>	<b>Option 1</b> Deputies at 3 <sup>rd</sup> / 4 <sup>th</sup> Ave Loading Dock	<b>Option 2</b> Deputies at 3 <sup>rd</sup> / 4 <sup>th</sup> Ave No Loading Dock	<b>Option 3</b> No Deputies at 3 <sup>rd</sup> / 4 <sup>th</sup> Ave Loading Dock	<b>Option 4</b> No Deputies at 3 <sup>rd</sup> / 4 <sup>th</sup> Ave No Loading Dock
Screeners	16	12	11	12	11
Deputies	5	10	9	5	5
Total Annual Costs	\$1,183,000	\$1,306,000	\$1,186,000	\$971,000	\$918,000
Fiscal Impact	\$0	\$123,000	\$3,000	(\$212,000)	(\$265,000)

Based on the utilization study, the primary driver of total annual operational costs is the security used at the exit only doors at the 3<sup>rd</sup> and 4<sup>th</sup> Avenue exits.

c. Other Staffing Needs

This analysis did not look at staffing needs outside of entrance security. For example, if the loading dock is eliminated, there could be additional needs for janitorial services to transport garbage out of the Courthouse. These additional needs will need to be considered if the project moves forward without the loading dock.

**B. Outreach to Principal User Groups and Public**

FMD performed an outreach study seeking comment from principal user groups of the Courthouse. FMD solicited comments from the following groups regarding renovation and relocation of entrances to the South entrance:

- King County Superior Court
- King County District Court
- King County Prosecuting Attorney's Office

- King County Sheriff
- Department of Judicial Administration
- Office of Civil Rights Enforcement
- Pioneer Square Historic Board
- King County Landmarks Board
- King County Bar Association

Restoring the south entrance was supported by all stakeholder groups provided that the level of security is not reduced and the City Hall park is cleaned up. A narrative matrix of responsive stakeholder comments is included in the outreach study, attached as **Appendix B**. General comments from principal users focused upon:

- Ensuring adequate security appropriate to the Courthouse and City Hall park, and
- Providing sufficient ADA access for persons with disabilities, including a passenger load/unload zone as close to the entrance as possible. The current zone is on Fourth Avenue.
- Retaining the same number of screening stations to prevent excessive wait times to enter the Courthouse.

### **C. Funding Analysis of South Entry Renovation**

FMD applied a life cycle cost analysis to each of the four options within the utilization study, assuming both construction of new loading dock facility and no new loading dock with a project life cycle of 40 years and a discount rate of 7%. Initial costs are reduced \$7.9 million by eliminating the loading dock facility. Under the lowest cost option, additional life cycle costs for a renovated south entry are estimated at \$2.2 million. Under the highest cost option, total life cycle costs equal \$12.3 million

#### **a. Project Capital Cost Estimates**

FMD prepared two cost estimate summaries for the project capital costs: one including a new loading dock underneath City Hall Park, accessed by the existing tunnel off of Fourth Avenue at the Jefferson Street right-of-way, and the second without the loading dock. Both cost estimate summaries include the renovation of the south entryway and lobby area, including escalators and ADA elevator.

Total project costs with the inclusion of a new loading dock facility are \$16,800,000 (See Option 3) Total project costs without a new loading dock are \$8,500,000 (See Option 2).

In addition, the project is the recipient of an \$800,000 grant from the Historic County Courthouse Rehabilitation Grant Program of the Washington Trust for Historic Preservation. This grant amounts are applied within the life cycle costs analysis below.

#### **b. Life Cycle Costs Analysis**

A life cycle costs analysis was applied to the OMB utilization study options that consolidated the current KCC street entrances into a single south entrance with three monitoring stations. Options 1 and 2 assume that additional security staff will be posted at the 3<sup>rd</sup> and 4<sup>th</sup> Avenue exits. Options 2 and 4 assume that a new loading dock will not need to be built.

**Table 2. Life Cycle Cost Analysis**

	<u>Option 1</u>	<u>Option 2</u>	<u>Option 3</u>	<u>Option 4</u>
	Deputies at 3rd / 4th Ave 4 Hr. Loading Dock	Deputies at 3rd / 4th Ave No Loading Dock	No Deputies at 3rd / 4th Aven 4 Hr. Loading Dock	No Deputies at 3rd / 4th Ave No Loading Dock
3rd and 4th avenue exit staffing	yes	Yes	no	no
3rd and 4th Avenue Security Doors	no	No	yes	yes
Loading Dock	4	0	4	0
Loading Dock Included	yes	No	yes	No
Capital Cost	\$16,500,000	\$8,500,000	\$16,900,000	\$8,900,000
Historic Preservation Grant	(\$800,000)	(\$800,000)	(\$800,000)	(\$800,000)
Annual Staffing Cost	\$123,000	\$3,000	(\$212,000)	(\$265,000)
LCC Capital	\$10,700,000	\$5,300,000	\$10,900,000	\$5,600,000
LCC Security Staffing	\$1,600,000	\$0	(\$2,700,000)	(\$3,400,000)
Total LCC	\$12,300,000	\$5,300,000	\$8,200,000	\$2,200,000
Debt Financing Annual Payments	\$1,113,954	\$546,334	\$1,142,335	\$574,715
Debt Payments with Staffing cost	\$1,236,954	\$549,334	\$930,335	\$309,715

**Notes:**

Capital cost assumes 25 year financing at 5% with 6% interim financing and transaction costs.

LCC Capital costs includes replacement of the elevator and escalators.

Staffing costs assume 3% annual inflation on salaries. Staffing costs do not include increases in janitorial or maintenance costs.

Analysis period is 40 years and use of a 7% real discount rate



Under the highest cost option, total life cycle costs equal \$11.9 million over 40 years. Under Option 4, total life cycle costs for a renovation of the KCC south entrance total \$1.9 million. The primary cost drivers are the level of security staff and the construction of the new loading dock. The operating costs associated with Park administrative control have not been included in the life cycle cost analysis because the operating costs have not been calculated at this stage of the negotiations and the County has not decided whether to take administrative control of the City Hall Park. The operating costs do not include any additional janitorial or maintenance costs that could be associated with the elimination of the KCC loading dock.

c. Financing Issues

The Council Adopted South Entry Motion called for an evaluation of funding considerations including debt capacity, grants, and property sale revenue.

**Debt Capacity:** The Current Expense fund debt policy limits debt payment levels to 5% of general fund revenue. Debt scheduled to be issued in the next few years will provide financing for the Integrated Security and Jail Health Project, the Elections facility, the Data Center replacement, and the Accountable Business Transformation project. Based on this planned debt issuance the unallocated general fund debt capacity is estimated to be approximately \$27 million in 2012. This equates to a 4.65% debt ratio, or 80% of total debt capacity. Taking a longer view, there won't be significant retirement of debt until 2017. Therefore, any unanticipated debt issuances between 2012 and 2017 will put the County at risk of exceeding the debt limit.

There are two other risk factors to consider in the debt capacity projections. First, the Debt Advisory Task Force has recommended that the debt ratio include the Current Expense fund share of the debt payments in the 63/20 financing arrangements. If approved, this policy change would move the Current Expense Fund closer to the debt limit as the Chinook Building debt payments would be included. The Current Expense Fund share of the Chinook Building debt has not been deducted from the \$75 million of remaining capacity pending action on the recommended policy decision.

Second, the County is in varying stages of an unprecedented number of facility master planning efforts. The District Court, Superior Court, King County Sheriff's Office, the Department of Adult and Juvenile Detention and the Health Department will each have a facility master plan. While it is too early to know the combination of projects that may be approved for debt financing it should be noted that, taken together, these projects amount to a total significantly greater than the amount of available debt capacity. In particular, the potential cost of adult detention facility capacity expansion, by itself, will exceed the available debt capacity. Though a proposed voter approved levy may be considered at a later date there are likely to be competing levy proposals on the ballot in the

next few years. It may be necessary to use remaining debt capacity to fund capital projects that represent an immediate need.

**Grants:** The cost analysis table on page 8 indicates the availability of an \$800,000 Historic County Courthouse Rehabilitation Grant Program of the Washington Trust for Historic Preservation. This grant has been awarded on a reimbursement basis and specifies specific project costs that have been included in the project cost estimates.

**Property Sales:** At the time of the Courthouse Lobby project approval in 2003 there were two district court sales pending. This \$2.3 million of Current Expense fund property sale proceeds was earmarked to provide revenue backing for a share of the \$6.7 million of project costs. In August of 2007 the Executive proposed the sale of the Kingdome North Lot. Though the sale remains in negotiation, it is estimated that the net sale proceeds could be approximately \$8.8 million after adjustments for transaction costs and the 10% transfer to the Cultural Development Authority. The North Lot transmittal letter recommended that the sale proceeds be reserved in the Current Expense fund to address the potential capital projects listed in the August 2007 transmittal letter excerpt shown below:

“Yesler/Courthouse Campus Current Expense Reserve

The almost ten million dollars in net proceeds provides King County with several unique and unprecedented opportunities to transform the sometimes troubled Yesler/City Hall Park area into a thriving and vibrant gateway to Pioneer Square and the North Lot development.

There are many important Executive and County Council initiatives in or around the Courthouse campus that are in various stages of analysis and implementation. These include:

- Securing development rights or title to properties immediately west of the New County Office Building;
- Potential housing, and redevelopment/improvement of the Courthouse campus itself, either on Goat Hill or in the Yesler area;
- Restoring a new south entrance to the Courthouse and linked improvements to City Hall Park;
- Replacing the existing King County Administration Building with a modern new office tower; and
- Removing the sky bridge from the jail to the Courthouse.

These options continue and support the initiatives set in motion with the development of the North Half Lot for making downtown a more livable and family friendly community.

These options also preserve and enhance King County government services and real property investments in the downtown core.

As a result of our conversations with multiple parties such as the City of Seattle, the Seattle Housing Authority, private developers and others, it has become clear that each of these projects might be linked in ways that benefit all of them. For example, the public benefits of the potential housing projects and City Hall Park improvements may grant us more square footage in a new office tower, which in turn may allow us to generate sufficient revenues to restore the south entrance to the Courthouse or remove the sky bridge.

It is too soon to say exactly how they may all fit together, but what is clear is that this ten million dollars can be a catalyst for one or all of these projects. We should not lose this incredible opportunity by spending the money elsewhere, but rather set the proceeds aside until a clear path for achieving these multiple objectives is reached by both the council and the Executive.”

The use of North Lot sale proceeds for the Courthouse South Entrance project could be contingent upon 1.) the successful conclusion of the sale negotiations, and 2.) a commitment by the City of Seattle to make park improvements.

#### **D. Issues to Consider**

##### **a. KCC Loading Dock Elimination**

Presently, the KCC loading dock is open eight hours a day. Relocation of a KCC loading dock from its present location at the south entrance would require that a new facility be built underground (at the terminus of the existing access tunnel from Fourth Avenue). If the loading dock were eliminated, screening of delivery packages could be performed remotely at the other county buildings during off peak hours. Large deliveries could continue to be facilitated through the Fourth Avenue entrance and scheduled after normal business hours (as is current practice). Trash and recycling material from the Courthouse can be transported via the existing inter-building tunnel system for processing in the Chinook Building (this tunnel is currently used to transport trash/recycling material from the Administration Building to the current loading dock). FMD's analysis demonstrates that the elimination of the loading dock would greatly reduce capital and operations costs.

While the cost savings associated with eliminating the KCC loading dock are large, the relationship of the KCC loading dock and the New Administration building must be understood. If a New Administration building is built, the lack of a loading dock at KCC can be easily and efficiently accommodated by the new building. However, if the New Administration Building is not constructed, there will be operational impacts such as trash handling to be addressed due to the lack of a loading dock at the KCC. In addition, future circumstances could create increased demand for traditional loading dock services. For example, if there is a substantial remodel of the KCC for CID, the PAO or Superior

Court, there might be significant operational impacts to the daily operations without a KCC loading dock.

b. New Security Equipment

The current capital cost estimate includes new security screening equipment that is of greater efficiency than the machines presently in use at the KCC. The new south entrance will utilize state of the art security screening equipment technologies that can improve staffing operations efficiency and pedestrian traffic flow. These improvements include flat screen monitors greeting the public upon entry, broadcasting short video instructions about how to proceed efficiently through the screening process. New walk through metal detectors will be sized for ADA passage, while packages, bags, keys, etc. will be x-rayed using smaller machines with longer rollout tables on each end. The longer tables, particularly at the exit end, will speed retrieval of items by providing space for more than a single person at a time.

This equipment, and other available equipment options, could potentially eliminate the need for three security stations at the south entrance, based on more efficient pedestrian movement through the security check. For example, a Millimeter Wave unit is an entirely new technology that identifies objects and locations on a person's body – eliminating the need for repeat trips through the metal detector. In addition, video observation and equipment interconnectivity could allow a single security officer to monitor all three stations from a single station point. KCSO should be engaged to take an active part in review of new equipment to maximize potential efficiencies in pedestrian traffic and operations.

c. Elevator Modifications to the Courthouse First Floor:

As currently designed, the planned staircase from the South Entrance down to the first floor will require removal of two elevator entries on the south side of the floor. The staircase will not require removal of elevators entries on the second floor. In the proposed elevator configuration it is likely that the majority of individuals entering the South Entrance will take the escalators to the second floor to enter the elevator compartments. The escalators will impact conference room and hallway space on the south side of the Courthouse second floor.

The new ADA elevator that can be entered at the South Entrance to travel to the first and second floor will remove square footage currently used by the food concession area on the first floor.

King County Courthouse South Entrance Renovation Report

**Attachment A: King County Office of Management and Budget**

**Courthouse South Entry Renovation Project**

- **Courthouse Utilization Study**

## Courthouse Utilization Study

### Summary

In 2007, the King County Office of Management and Budget conducted a study of pedestrian utilization of the King County Courthouse entrances to inform decision-making regarding the potential renovation and reopening of the South Entrance. The goal of the study was to determine whether efficiencies could be achieved by reducing the total number of entrances to the Courthouse from three to two.

### Major Findings

- The King County Courthouse requires four full screening stations to accommodate foot traffic during peak hours. If there are fewer than four stations, long lines will occur more frequently during peak hours.
- Efficiencies can be gained if the four stations are consolidated into two entrances. (Currently, four stations are spread over three entrances.)
- OMB identified four staffing options. The highest cost option produced \$123,000 in additional annual costs. The lowest cost option produced \$265,000 in annual savings.
- The operational costs of the security staffing options vary based on the level of security and the hours of the loading dock. Options 1 and 2 assume that court deputies must be stationed at the 3<sup>rd</sup> Avenue and 4<sup>th</sup> Avenue exits. This assumption increases the cost of securing the building. Options 1 and 3 assume that the KCCH loading dock operates four hours per day. Options 2 and 4 assume that the loading dock is eliminated and does not require security staffing.<sup>1</sup>

	<b>Current Staffing</b>	<b>Option 1</b> Deputies at 3 <sup>rd</sup> / 4 <sup>th</sup> Ave Loading Dock	<b>Option 2</b> Deputies at 3 <sup>rd</sup> / 4 <sup>th</sup> Ave No Loading Dock	<b>Option 3</b> No Deputies at 3 <sup>rd</sup> / 4 <sup>th</sup> Ave Loading Dock	<b>Option 4</b> No Deputies at 3 <sup>rd</sup> / 4 <sup>th</sup> Ave No Loading Dock
Screeners	16	12	11	12	11
Deputies	5	10	9	5	5
Total Annual Costs	\$1,183,000	\$1,306,000	\$1,186,000	\$971,000	\$918,000
Fiscal Impact	\$0	\$123,000	\$3,000	(\$212,000)	(\$265,000)

<sup>1</sup> These options only considered security costs. This study did not include operational costs associated with building maintenance.

**Introduction**

In 2007, the King County Office of Management and Budget conducted a study of traffic patterns at the King County Courthouse to inform decision-making regarding the potential renovation and reopening of the South Entrance. The goal of the study was to determine whether efficiencies could be achieved by reducing the number of entrances from three to two. This report documents the major findings of this study.

The King County Courthouse currently has three entrances which are located at Third Avenue, Fourth Avenue, and the Tunnel to the Administration Building. The Third Avenue entrance has two full screening stations which are both opened during peak hours. The Fourth Avenue and Tunnel entrances each have one full screening station. The screening stations include an X-Ray machine to scan personal belongings and a Magnetometer. Current security protocols mandate that all personal effects must be screened.

**I. Traffic Study**

Traffic data was collected during the months of July and August. Traffic counts were taken at each entrance for each hour of the day on every day of the week. The count was recorded at fifteen minute increments. Additionally, OMB took note of the number of times that a queue formed with more than 10 individuals. Detailed information on the counts can be found in Appendix A.

***Finding #1: Traffic flows in a predictable pattern with peaks occurring between 8:00 and 9:00 A.M. and 12:30 and 1:30 P.M. (See Table 1.)***

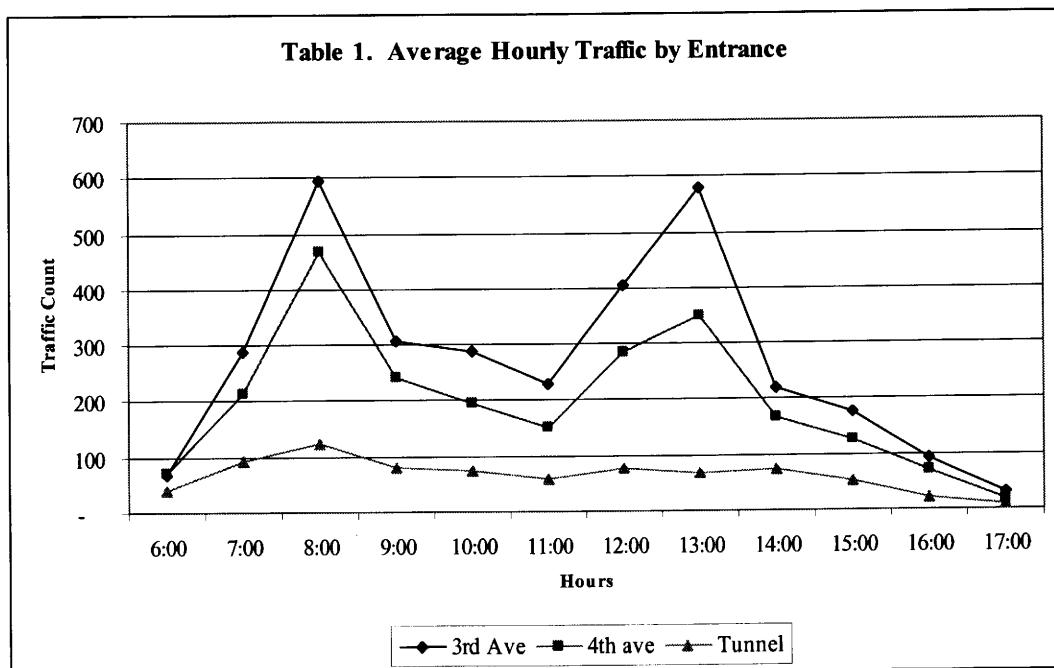
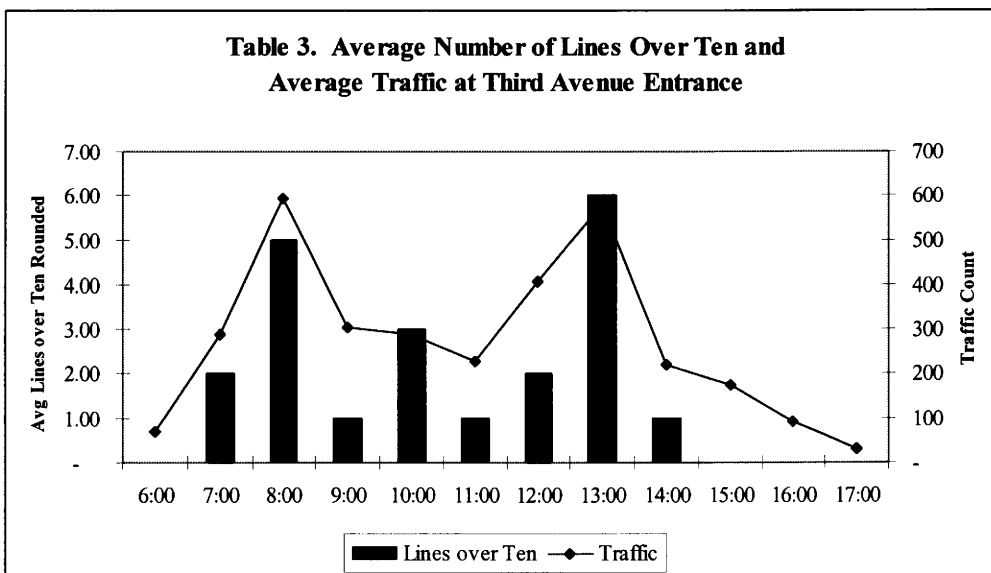
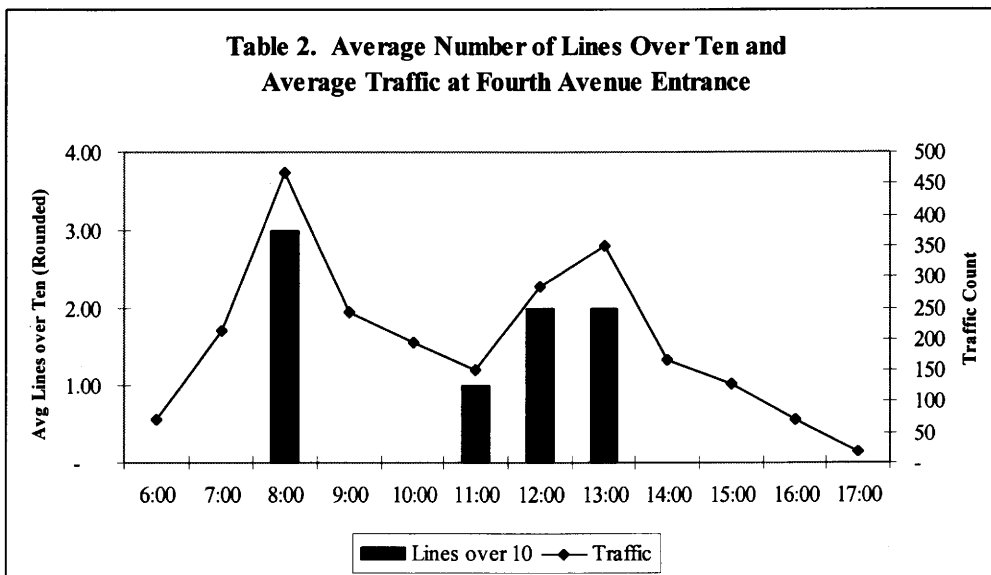

Table 1 shows the average traffic count per hour at each entrance. The highest traffic counts occurred at Third Avenue while the lowest counts occurred at the tunnel.

**Finding #2: The formation of queues greater than 10 is strongly associated with the amount of traffic coming through the doors.**

Table 2 shows the average number of queues over ten that occurred at the Fourth Avenue entrance. Between two and three queues occurred at this entrance during the peak traffic hours. Similar trends can be observed at the Third Avenue entrance (see Table 3). Long lines were not observed at the tunnel entrance.





***Finding #3: If the Third and Fourth Avenue entrances are closed, the traffic from those entrances will most likely be diverted to the South Entrance. However, some of the overflow could be diverted to the Tunnel.***

OMB used the data collected to evaluate the operational impact of closing the Third and Fourth Avenue entrances and reopening the South Entrance. Two scenarios were developed to predict the likely flow of traffic at the South Entrance. Under the first scenario, all of the traffic from the closed Third and Fourth Avenue entrances would flow to the South Entrance. Under the second scenario, two thirds of the building traffic would flow to the South Entrance and one third would flow to the tunnel. These scenarios represent two extremes. It is likely that some individuals entering from street level will use the tunnel if they notice long queues forming at the South Entrance. Others may be unfamiliar with the Tunnel entrance and could choose to remain at the South Entrance.

**Table 4. Two Scenarios of Traffic Flow**

Hour	Scenario One: High Traffic Flow to South Entrance		Scenario Two: Lower Traffic Flow to South Entrance	
	South Entrance	Tunnel	South Entrance	Tunnel
6:00	138	39	118	58
7:00	501	94	399	196
8:00	1,061	125	795	391
9:00	549	80	421	207
10:00	483	73	372	183
11:00	380	59	295	145
12:00	689	78	514	253
13:00	928	68	667	329
14:00	388	75	310	153
15:00	304	53	239	118
16:00	163	22	124	61
17:00	51	10	41	20

These decisions will be influenced by the screening capacity available at each entrance. Currently, there are four screening stations available at the three entrances. To accommodate the traffic under Scenario One, three screening stations would need to be available at the South Entrance and one station would need to be available at the Tunnel.

To determine the operational impact of these scenarios, OMB built a model that described the relationship between increases in the amount of traffic per screening stations and the probability of a queue forming (see Table 5).<sup>2</sup> This model was used to predict the likelihood of queues given variation in the number of screening stations.

<sup>2</sup> Traffic counts per station were rounded to the nearest twenty. The probability of a line forming was calculated for each group of twenty and graphed in Table 5. An exponential function was fit to the data that describes the relationship between the traffic per station and the probability of a line forming.

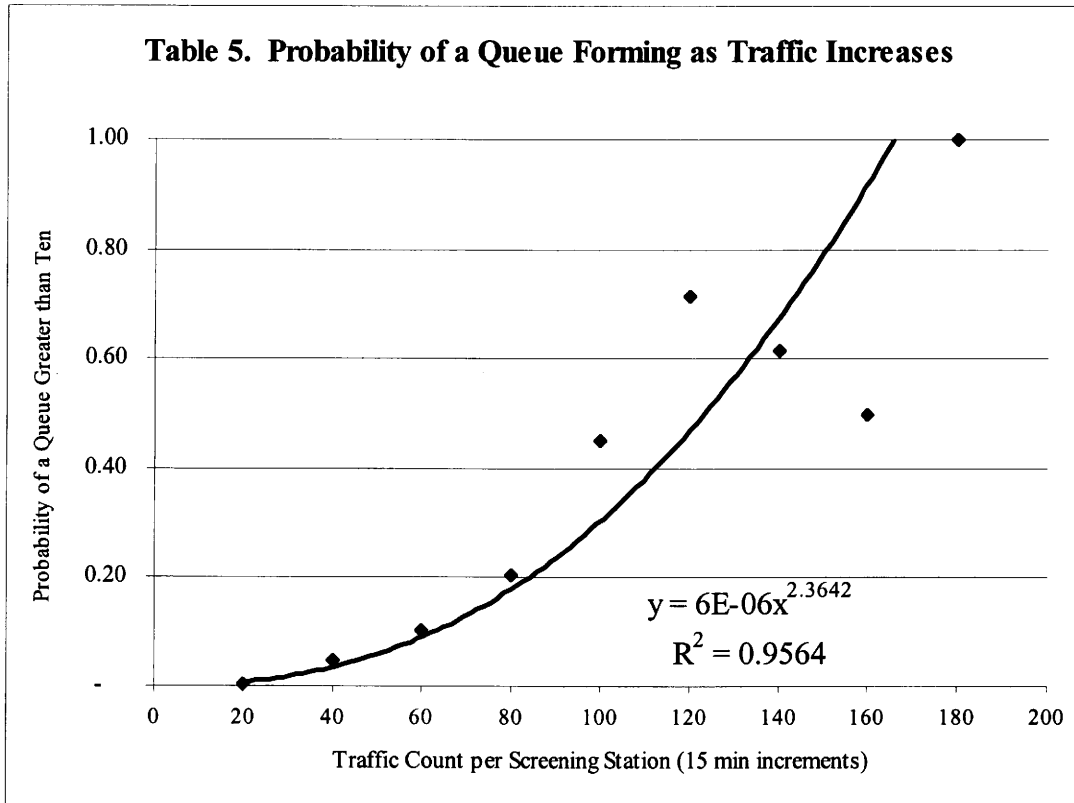

***Finding #5: The likelihood of queues forming will more than double if the total number of screening stations is reduced.***

OMB used the traffic model in Table 5 to determine the likelihood of long lines forming at the South Entrance during peak hours. The model was tested on four scenarios:

- *Scenario 1A* assumes that all of the traffic from the Third and Fourth entrance will flow to the South Entrance, the tunnel traffic will remain unchanged, three screening stations will be available at the South Entrance, and one station will be available at the tunnel.
- *Scenario 1B* assumes that all of the traffic from the Third and Fourth entrance will flow to the South Entrance, the tunnel traffic will remain unchanged, two screening stations will be available at the South Entrance, and one station will be available at the tunnel.
- *Scenario 2A* assumes that two thirds of the building traffic will flow to the South Entrance, one third of the traffic will flow to the tunnel, three screening stations will be available at the South Entrance, and one station will be available at the tunnel.
- *Scenario 2B* assumes that two thirds of the building traffic will flow to the South Entrance, one third of the traffic will flow to the tunnel, two screening stations will be available at the South Entrance, and one station will be available at the tunnel.

Table 6 shows the probability of a line forming between 8:00 and 9:00 A.M for the scenarios that assume no traffic is diverted to the tunnel (1A and 1B). Both of these scenarios assume high traffic flows. However, Scenario 1A assumes three stations are open and Scenario 1B assumes two stations are open. With fewer stations available, the likelihood a line forming increases by 261%. For example, with three stations open, there is a 36% chance of a queue forming between 8:30 and 8:45. If the number of stations is reduced to two, the likelihood of a line forming increases to 93%.

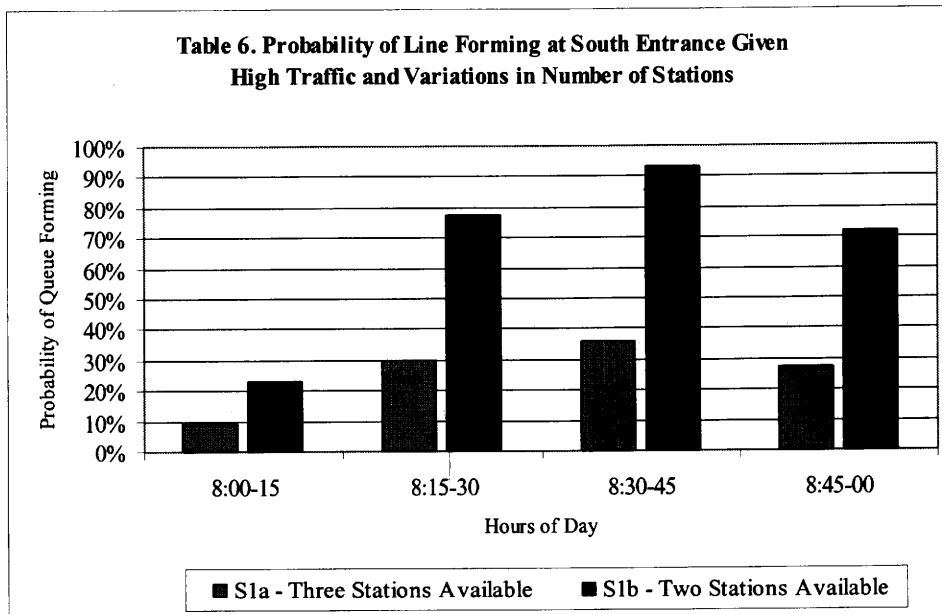
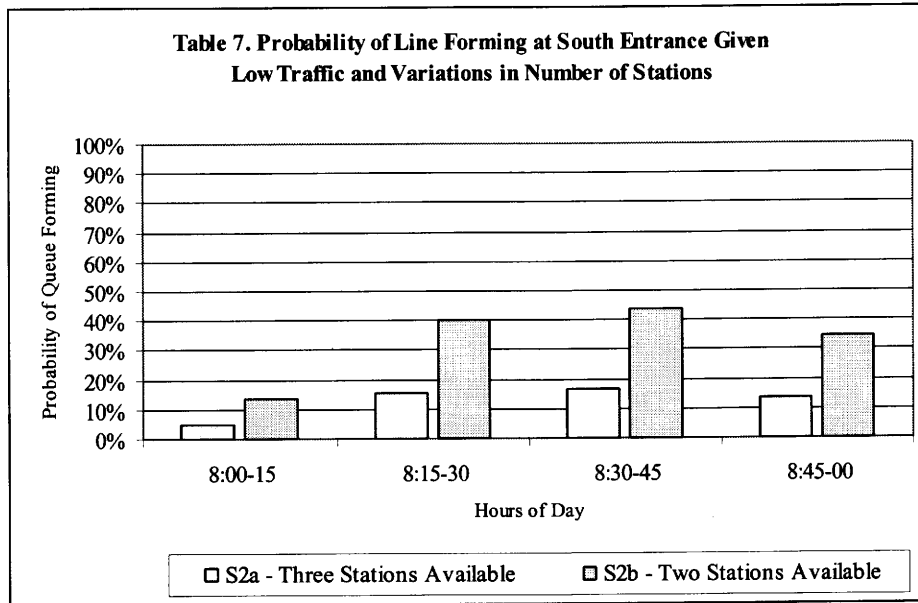

Table 7 shows Scenarios 2A and 2B that assume that some of the traffic can be diverted to the tunnel. Given the lower traffic levels, the overall likelihood of a line forming is lower than the high traffic scenarios. However, reducing the number of stations still has an impact on queuing.

It should be noted that these scenarios are based on data from summer traffic counts. The total traffic flow is likely to increase in the fall and winter when a greater number of court cases are active. For this reason, the higher traffic scenario is a better source of information for planning purposes.



***Finding #6: Four screening stations are required to meet the demands of traffic flow during peak hours.***

To maintain the current level of service, at least four screening stations should be available during peak hours. Having four stations will reduce the likelihood of long lines.

***Finding #7: Traffic flows at the Loading Dock are very low. FMD should determine whether the loading dock could be eliminated.***

OMB also counted the number of entrants to the loading dock. The total volume averaged 37 per day. The County should consider the cost effectiveness of operating the loading dock. FMD, in consultation with the Sheriff, should determine whether freight shipments could be delivered at other County buildings and transmitted to the Courthouse via the tunnels.

**Table 8. Average Hourly Traffic at the Loading Dock**

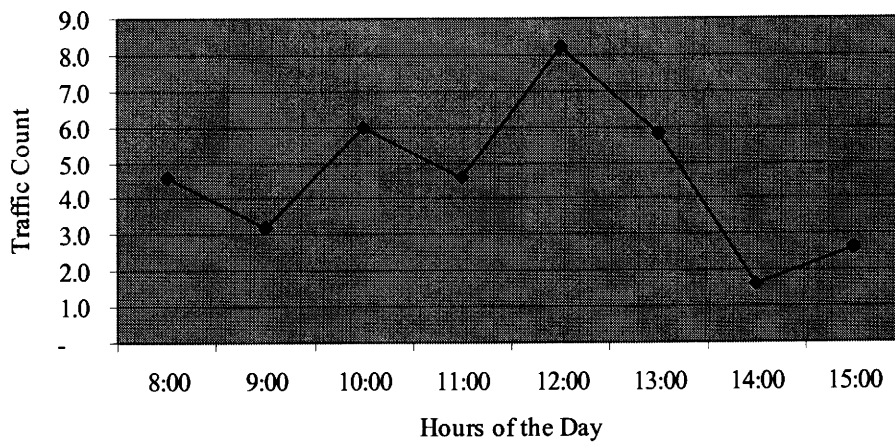

## II. Analysis of Staffing Options

OMB used the findings of the traffic study to estimate the operational costs of the South Entrance project. Currently, King County spends approximately \$1.2 million to staff the security stations at each entrance. These entrances are staffed by approximately 16 weapons screeners and 5 court deputies.<sup>3</sup> Reconfiguring the entrances will undoubtedly alter the amount of security staffing required and could increase or decrease the total operational costs.

OMB developed a range of staffing options to accommodate the expected levels of traffic at a reopened South Entrance. The options were designed to optimize the number of screening stations available at different hours of the day. Details on each option can be found in Appendix B.

The four options discussed in this section vary based on security needs and the hours of the loading dock.

**Security Needs:** The Sheriff's Office expressed concern that converting the Third and Fourth Avenue entrances to exit only doors could create security risks. The Sheriff's Office recommended staffing the exit only doors with court deputies. These additional staffing needs increase the cost of securing the building. Alternatively, capital equipment (e.g. sallyport doors, cameras, alarms, etc.) could be installed in lieu of stationed personnel.

In May 2007, a study of Courthouse security was conducted by the U.S. Marshal Service. The study recommended increasing the level of security staff in the Courthouse. These recommendations were not included in the options developed for this report. OMB only considered security needs that were directly related to the reconfiguration of the entryways.

**Loading Dock:** Currently, the loading dock is open eight hours a day. The traffic study demonstrated that the loading dock only received 37 entrants per day. This has led OMB to conclude that the hours could be reduced to optimize efficiency. Further efficiencies could be achieved if the loading dock were eliminated altogether. In this case, deliveries would need to be scheduled for off-peak hours and delivered via the tunnel entrance.

Options 1 and 2 assume that court deputies will be placed at the closed street level entrances (see Table 9). These options are the most expensive alternatives. Options 1 and 3 assume that the loading dock will operate four hours a day. Options 2 and 4 assume that the loading dock is eliminated.

---

<sup>3</sup> These estimates do not include supervisors.

**Table 9. Operational Fiscal Impact of Staffing Courthouse Entrances**

	<b>Current Staffing</b>	<b>Option 1</b> Deputies at 3 <sup>rd</sup> / 4 <sup>th</sup> Ave Loading Dock	<b>Option 2</b> Deputies at 3 <sup>rd</sup> / 4 <sup>th</sup> Ave No Loading Dock	<b>Option 3</b> No Deputies at 3 <sup>rd</sup> / 4 <sup>th</sup> Ave Loading Dock	<b>Option 4</b> No Deputies at 3 <sup>rd</sup> / 4 <sup>th</sup> Ave No Loading Dock
Screeners	16	12	11	12	11
Deputies	5	10	9	5	5
Total Annual Costs	\$1,183,000	\$1,306,000	\$1,186,000	\$971,000	\$918,000
Fiscal Impact	\$0	\$123,000	\$3,000	(\$212,000)	(\$265,000)

Note: These options represent an approximation of costs. Staffing level and scheduling considerations could create constraints which could increase or decrease estimates.

These options only consider the costs of securing each entrance and does not include changes in building maintenance costs. For example, if the loading dock is eliminated, there could be additional needs for janitorial services to transport garbage out of the Courthouse. These additional needs will need to be considered if the project moves forward without the loading dock.

**Other Considerations:** The traffic study demonstrates that the Courthouse requires four security stations during peak traffic hours. The options developed assume that three of these stations could be accommodated in the South Entrance. The Sheriff's Office has expressed concern that the high level of traffic coming through three stations could create confusion and pose a security risk.

If the South Entrance is not equipped with three stations, the County could develop a strategy to divert a large share of the street level traffic to the tunnel. Under this scenario, a second screening station could be moved to the Tunnel to accommodate the increase in traffic during peak hours. This alternative configuration would not alter the cost estimates developed in Table 9. Additionally, FMD and the Sheriff's Office could develop process improvements that speed the flow of traffic through the screening stations. If these strategies are not successful, the County may need to open the Third or Fourth Avenue entrance to accommodate the extra traffic. This would add to the operational costs of the project. Alternatively, the County could accept long queues during peak hours.

### **Conclusion**

OMB has developed a range of cost estimates for staffing the secured entryways to the Courthouse. The highest cost option would add \$123,000 in annual operational costs. The lowest cost option could produce \$265,000 in savings. The range in costs is primarily dependent on the level of security provided at the entryways.

**Table 10. Assumptions Used to Develop Options**

	<b>Option 1</b>	<b>Option 2</b>	<b>Option 3</b>	<b>Option 4</b>
	Deputies at 3 <sup>rd</sup> / 4 <sup>th</sup> Ave Loading Dock	Deputies at 3 <sup>rd</sup> / 4 <sup>th</sup> Ave No Loading Dock	No Deputies at 3 <sup>rd</sup> / 4 <sup>th</sup> Ave Loading Dock	No Deputies at 3 <sup>rd</sup> / 4 <sup>th</sup> Ave No Loading Dock
<b>Security Considerations</b>				
Enhanced Security on Loading Dock	Yes	No	No	No
Enhanced Security on Exits	Yes	Yes	No	No
<b>Number of Screening Stations per Entrance</b>				
South Entrance	3 Stations	3 Stations	3 Stations	3 Stations
Tunnel	1 Station	1 Station	1 Station	1 Station
3rd Ave	Exit Only	Exit Only	Exit Only	Exit Only
4th Ave	Exit Only	Exit Only	Exit Only	Exit Only
<b>Operational Hours</b>				
Loading Dock Hours	4	0	4	0
South Entrance	12	12	12	12
Tunnel	12	12	12	12



**Appendix A. Daily Traffic Counts****Third Avenue Entrance**

Hour	Monday	Tuesday	Wednesday	Thursday	Friday	Total
6:00	70	71	67	77	53	338
7:00	355	279	358	240	206	1438
8:00	572	774	584	551	489	2970
9:00	293	270	334	311	323	1531
10:00	348	329	194	321	246	1438
11:00	233	218	215	239	238	1143
12:00	521	454	377	387	289	2028
13:00	589	611	667	617	411	2895
14:00	237	210	201	261	198	1107
15:00	186	161	196	155	180	878
16:00	109	74	87	110	85	465
17:00	38	18	28	34	38	156
<b>Total</b>	<b>3551</b>	<b>3469</b>	<b>3308</b>	<b>3303</b>	<b>2756</b>	<b>16387</b>

**Fourth Avenue Entrance**

Hour	Monday	Tuesday	Wednesday	Thursday	Friday	Total
6:00	80	76	81	66	47	350
7:00	248	222	230	197	172	1069
8:00	452	548	519	471	345	2335
9:00	236	282	237	229	230	1214
10:00	202	187	187	212	188	976
11:00	168	139	168	157	126	758
12:00	307	281	324	314	192	1418
13:00	392	327	335	405	287	1746
14:00	172	124	181	168	190	835
15:00	141	125	148	109	117	640
16:00	72	59	90	73	55	349
17:00	26	5	10	49	9	99
<b>Total</b>	<b>2496</b>	<b>2375</b>	<b>2510</b>	<b>2450</b>	<b>1958</b>	<b>11789</b>

**Tunnel Entrance**

Hour	Monday	Tuesday	Wednesday	Thursday	Friday	Total
6:00	54	45	46	38	12	195
7:00	113	91	106	79	80	469
8:00	118	142	156	131	79	626
9:00	69	80	75	100	74	398
10:00	78	81	66	81	59	365
11:00	55	58	55	49	80	297
12:00	63	87	69	69	104	392
13:00	84	68	48	53	85	338
14:00	77	69	96	62	69	373
15:00	43	67	56	64	34	264
16:00	14	24	31	26	15	110
17:00	9	16	7	13	5	50
<b>Total</b>	<b>777</b>	<b>828</b>	<b>811</b>	<b>765</b>	<b>696</b>	<b>3877</b>

**Loading Dock**

	Monday	Tuesday	Wednesday	Thursday	Friday	Total
8:00	1	2	11	4	5	23
9:00	7	2	1	1	5	16
10:00	12	4	1	8	5	30
11:00	6	3	1	8	5	23
12:00	11	8	3	5	14	41
13:00	10	7	2	1	9	29
14:00	1	2	3	1	1	8
15:00	0	5	1	4	3	13
	<b>48</b>	<b>33</b>	<b>23</b>	<b>32</b>	<b>47</b>	<b>183</b>

**Appendix B. Detailed Staffing Options**

**OPTION 1**

**KEY ASSUMPTIONS**

South Entrance (S.E.)	3rd Ave	4th Ave	Tunnel	Loading Dock (L.D.) Hours	Extra Staff on Exits
3 Stations	Exit Only	Exit Only	1 Station	4	Yes

**WEAPONS SCREENERS**

	Current Staffing				Proposed Staffing				Total	Difference		
	3rd - A	3rd - B	4th	Tunnel	L.D.	3rd - A	3rd - B	4th			Tunnel	L.D.
6.00	3		2	1					1		4	(2)
7.00	3	3	3	2					2		8	(3)
8.00	3	3	3	2	1				2		11	(1)
9.00	3	3	3	2	1				2		11	(1)
10.00	3	3	3	2	1				2		9	(3)
11.00	3	3	3	2	1				2	1	9	(3)
12.00	3	3	3	2	1				2	1	11	(1)
13.00	3	3	3	2	1				2	1	9	(3)
14.00	3	3	3	2	1				2	1	9	(3)
15.00	3	3	3	2	1				2	1	5	(4)
16.00	3	3	3	2	1				2	1	5	(3)
17.00	3	2	2	1					2		4	(2)
Total Hrs	36	24	34	22	8			0	0	0	95	(29)
Annual Hrs	9,000	6,000	8,500	5,500	2,000			-	-	-	23,750	(7,250)
FTEs											12.0	(4.0)

**COURT DEPUTIES**

	Current Staffing				Proposed Staffing				Total	Difference		
	3rd - A	3rd - B	4th	Tunnel	L.D.	3rd - A	3rd - B	4th			Tunnel	L.D.
6.00	1		1	1				1	1		5	2
7.00	1		1	1				1	1		5	2
8.00	2		2	1				1	1		8	3
9.00	2		2	1				1	2		8	3
10.00	1		1	1				1	1		7	4
11.00	1		1	1				1	1	2	7	4
12.00	1		1	1				1	2		7	4
13.00	2		2	1				1	1	2	8	3
14.00	1		1	1				1	1	2	7	4
15.00	1		1	1				1	1	2	5	2
16.00	1		1	1				1	1	1	5	2
17.00	1		1	1				1	1	1	5	2
Total Hrs	15	0	15	12	0			15	0	12	77	35
Annual Hrs	3,750	-	3,750	3,000	-			3,000	3,000	1,500	19,250	8,750
FTEs											10.0	5.0

**FISCAL IMPACT**

Current Staffing				Proposed Staffing				Difference			
Security Screeners	Deputies	FTEs	Total Cost	Security Screeners	Deputies	FTEs	Total Cost	Security Screeners	Deputies	FTEs	Total Cost
16	5	16	\$848,000	12	10	12	\$636,000	(4)	5	(4)	(212,000)
5	5	10	\$335,000	10	10	10	\$670,000	5	5	5	335,000
			\$1,183,000				\$1,306,000				123,000

OPTION 2

KEY ASSUMPTIONS

South Entrance (S.E.)	3rd Ave	4th Ave	Tunnel	Loading Dock (L.D.) Hours	Extra Staff on Exits
3 Stations	Exit Only	Exit Only	1 Station	0	Yes

WEAPONS SCREENERS

	Current Staffing				Proposed Staffing				Difference							
	3rd - A	3rd - B	4th	Tunnel	L.D.	Total	3rd - A	3rd - B		4th	S.E. - A	S.E. - B	S.E. - C	Tunnel	L.D.	Total
6.00	3		2	1		6				3			1		4	(2)
7.00	3		3	2		8				3	3		2		8	
8.00	3	3	3	2	1	12				3	3	3	2		11	(1)
9.00	3	3	3	2	1	12				3	3	3	2		11	(1)
10.00	3	3	3	2	1	12				3	3	3	2		8	(4)
11.00	3	3	3	2	1	12				3	3	3	2		8	(4)
12.00	3	3	3	2	1	12				3	3	3	2		8	(4)
13.00	3	3	3	2	1	12				3	3	3	2		11	(1)
14.00	3	3	3	2	1	12				3	3	3	2		8	(4)
15.00	3	3	3	2	1	12				3	3	3	2		5	(7)
16.00	3	3	3	2	1	12				3	3	3	2		5	(3)
17.00	3		2	1		6				3			1		4	(2)
Total Hrs	36	24	34	22	8	124	0	0	0	36	24	9	22	0	91	(33)
Annual Hrs	9,000	6,000	8,500	5,500	2,000	31,000	-	-	-	9,000	6,000	2,250	5,500	-	22,750	(8,250)
FTEs						16.0									11.0	(5.0)

COURT DEPUTIES

	Current Staffing				Proposed Staffing				Difference							
	3rd - A	3rd - B	4th	Tunnel	L.D.	Total	3rd - A	3rd - B		4th	S.E. - A	S.E. - B	S.E. - C	Tunnel	L.D.	Total
6.00	1		1	1		3	1		1	1	1		1		5	2
7.00	1		1	1		3	1		1	1	1		1		5	2
8.00	2		2	1		5	1		1	1	2		1		7	2
9.00	2		2	1		5	1	1	1	1	2		1		8	3
10.00	1		1	1		3	1	1	1	1	1		1		6	3
11.00	1		1	1		3	1	1	1	1	1		1		5	2
12.00	1		1	1		3	1	1	1	1	1		1		5	2
13.00	2		2	1		5	1	1	1	1	2		1		8	3
14.00	1		1	1		3	1	1	1	1	1		1		5	2
15.00	1		1	1		3	1	1	1	1	1		1		5	2
16.00	1		1	1		3	1	1	1	1	1		1		5	2
17.00	1		1	1		3	1	1	1	1	1		1		5	2
Total Hrs	15	0	15	12	0	42	12	3	12	12	12	6	12	0	69	27
Annual Hrs	3,750	-	3,750	3,000	-	10,500	3,000	750	3,000	3,000	3,000	1,500	3,000	-	17,250	6,750
FTEs						5.0									9.0	4.0

FISCAL IMPACT

Current Staffing	FTEs		Total Cost		Proposed Staffing	FTEs		Total Cost		Difference	FTEs		Total Cost	
	Security Screeners	Deputies	\$53,000	\$848,000		Security Screeners	Deputies	\$53,000	\$848,000		Security Screeners	Deputies	\$53,000	\$848,000
	16	5	\$848,000	\$335,000		11	9	\$583,000	\$603,000		(5)	4	(265,000)	
Total Cost			\$1,183,000		Total Cost			\$1,156,000		Total Cost			3,000	

**OPTION 3**

**KEY ASSUMPTIONS**

South Entrance (S.E.)	3rd Ave	4th Ave	Tunnel	Loading Dock (L.D.)	Extra Staff on Exits
3 Stations	Exit Only	Exit Only	1 Station	4	No

**WEAPONS SCREENERS**

	Current Staffing				Proposed Staffing				Total	L.D.	S.E.-C	Tunnel	L.D.	Total	Difference
	3rd - A	3rd - B	4th	Tunnel	3rd - A	3rd - B	4th	S.E.-A							
6.00	3	2	1	1	6	3	3	1	1	9	2	2	4	(2)	
7.00	3	3	2	2	8	3	3	2	2	3	3	2	5	(3)	
8.00	3	3	2	1	12	3	3	2	2	3	3	2	11	(1)	
9.00	3	3	2	1	12	3	3	2	2	3	3	2	11	(1)	
10.00	3	3	2	1	12	3	3	2	2	3	3	2	9	(3)	
11.00	3	3	2	1	12	3	3	2	2	3	3	2	9	(3)	
12.00	3	3	2	1	12	3	3	2	2	3	3	2	11	(1)	
13.00	3	3	2	1	12	3	3	2	2	3	3	2	9	(3)	
14.00	3	3	2	1	12	3	3	2	2	3	3	2	9	(3)	
15.00	3	3	2	1	12	3	3	2	2	3	3	2	8	(4)	
16.00	3	3	2	2	8	3	3	2	2	3	3	2	5	(3)	
17.00	3	2	1	1	6	3	2	1	1	3	2	1	4	(2)	
Total Hrs	36	24	34	22	124	0	0	0	36	24	9	22	4	95	(29)
Annual Hrs	9,000	6,000	8,500	5,500	31,000	-	-	-	9,000	6,000	2,250	5,500	1,000	23,750	(7,250)
FTEs					16.0									12.0	(4.0)

**COURT DEPUTIES**

	Current Staffing				Proposed Staffing				Total	L.D.	S.E.-C	Tunnel	L.D.	Total	Difference
	3rd - A	3rd - B	4th	Tunnel	3rd - A	3rd - B	4th	S.E.-A							
6.00	1	1	1	1	3	1	1	1	1	1	1	1	3	-	
7.00	1	1	1	1	3	1	1	1	1	1	1	1	3	-	
8.00	2	2	2	1	5	1	1	1	1	2	1	1	5	-	
9.00	2	2	2	1	5	1	1	1	1	2	1	1	5	-	
10.00	1	1	1	1	3	1	1	1	1	1	1	1	3	-	
11.00	1	1	1	1	3	1	1	1	1	1	1	1	3	-	
12.00	1	1	1	1	3	1	1	1	1	1	1	1	3	-	
13.00	2	2	2	1	5	1	1	1	1	2	1	1	5	-	
14.00	1	1	1	1	3	1	1	1	1	1	1	1	3	-	
15.00	1	1	1	1	3	1	1	1	1	1	1	1	3	-	
16.00	1	1	1	1	3	1	1	1	1	1	1	1	3	-	
17.00	1	1	1	1	3	1	1	1	1	1	1	1	3	-	
Total Hrs	15	0	15	12	42	0	0	0	12	12	6	12	0	42	-
Annual Hrs	3,750	-	3,750	3,000	10,500	-	-	-	3,000	3,000	1,500	3,000	-	10,500	-
FTEs					5.0									5.0	-

**FISCAL IMPACT**

Current Staffing	FTEs		Total Cost	Proposed Staffing		Difference	
	Security Screeners	Deputies		Security Screeners	Deputies	Security Screeners	Deputies
Security Screeners	16	5	\$945,000	12	5	\$635,000	(4)
Deputies	5	5	\$335,000	5	5	\$335,000	-
Total Cost			\$1,183,000			\$971,000	(212,000)

OPTION 4

KEY ASSUMPTIONS

South Entrance (S.E.)	3rd Ave	4th Ave	Tunnel	Loading Dock (L.D.) Hours	Extra Staff on Exits
3 Stations	Exit Only	Exit Only	1 Station	0	No

WEAPONS SCREENERS

Current Staffing	Proposed Staffing						Total	L.D.	Tunnel	L.D.	S.E. - C	Tunnel	L.D.	Total	Difference
	3rd - A	3rd - B	4th	Tunnel	L.D.	Total									
6.00	3	2	1	3	3	1	4	1	1	2	2	4	2	(2)	
7.00	3	3	2	3	3	2	8	2	2	3	3	5	3	(3)	
8.00	3	3	2	3	3	2	12	2	2	3	3	11	11	(1)	
9.00	3	3	2	3	3	2	12	2	2	3	3	11	11	(1)	
10.00	3	3	2	3	3	2	12	2	2	3	3	8	8	(4)	
11.00	3	3	2	3	3	2	12	2	2	3	3	8	8	(4)	
12.00	3	3	2	3	3	2	12	2	2	3	3	11	11	(1)	
13.00	3	3	2	3	3	2	12	2	2	3	3	8	8	(4)	
14.00	3	3	2	3	3	2	12	2	2	3	3	8	8	(4)	
15.00	3	3	2	3	3	2	12	2	2	3	3	8	8	(4)	
16.00	3	3	2	3	3	2	8	2	2	3	3	5	5	(3)	
17.00	3	2	1	3	3	1	6	1	1	3	3	4	4	(2)	
Total Hrs	36	24	34	22	8	124	2,000	22	22	9	22	0	91	(33)	
Annual Hrs	9,000	6,000	8,500	5,500	2,000	31,000	2,000	5,500	5,500	6,000	2,250	0	22,750	(8,250)	
FTEs						16.0								11.0	(5.0)

COURT DEPUTIES

Current Staffing	Proposed Staffing						Total	L.D.	Tunnel	L.D.	S.E. - C	Tunnel	L.D.	Total	Difference
	3rd - A	3rd - B	4th	Tunnel	L.D.	Total									
6.00	1	1	1	1	1	3	3	1	1	1	1	3	3	-	
7.00	1	1	1	1	1	3	3	1	1	1	1	3	3	-	
8.00	2	2	2	2	2	5	5	2	2	2	2	5	5	-	
9.00	2	2	2	2	2	5	5	2	2	2	2	5	5	-	
10.00	1	1	1	1	1	3	3	1	1	1	1	3	3	-	
11.00	1	1	1	1	1	3	3	1	1	1	1	3	3	-	
12.00	1	1	1	1	1	3	3	1	1	1	1	3	3	-	
13.00	2	2	2	2	2	5	5	2	2	2	2	5	5	-	
14.00	1	1	1	1	1	3	3	1	1	1	1	3	3	-	
15.00	1	1	1	1	1	3	3	1	1	1	1	3	3	-	
16.00	1	1	1	1	1	3	3	1	1	1	1	3	3	-	
17.00	1	1	1	1	1	3	3	1	1	1	1	3	3	-	
Total Hrs	15	0	15	12	0	42	0	12	12	6	12	0	42	-	
Annual Hrs	3,750	-	3,750	3,000	-	10,500	-	3,000	3,000	1,500	3,000	0	10,500	-	
FTEs						5.0								5.0	-

FISCAL IMPACT

Current Staffing				Proposed Staffing				Difference						
FTE Cost	FTEs	Total Cost		FTE Cost	FTEs	Total Cost		FTE Cost	FTEs	Total Cost		FTE Cost	FTEs	Total Cost
\$53,000	16	\$448,000		\$53,000	11	\$583,000		\$53,000	11	\$583,000		\$53,000	5	-\$265,000
\$67,000	5	\$335,000		\$67,000	5	\$335,000		\$67,000	5	\$335,000		\$67,000	5	-
Total Cost		\$1,183,000		Total Cost		\$918,000		Total Cost		\$918,000		Total Cost		-\$265,000





King County Courthouse South Entrance Renovation Report

**Attachment B: King County Department of Executive Services –  
Facilities Management Division**

**Courthouse South Entry Renovation Project**

- **Public Outreach Study**

**King County South Entry Renovation  
Outreach and Consultation with Key Stakeholders  
Executive Summary**

Council Ordinance 15333, Section 114 required a study of the public use and the impacts to public access of both the reopened south entrance and the potential closure of the east and west entrances. The study was conducted in an outreach method to seek comment from principal user groups of the Courthouse. Stakeholders solicited for comment included those elected officials (other than the Council and Executive) where public functions are housed in the Courthouse, along with the department agencies located in the building.

**Outreach Groups Presented and Asked for Comment**

Superior Court  
District Court  
Prosecuting Attorneys Office  
King County Sheriff  
Office of Civil Rights Enforcement

Department of Judicial Administration  
King County Bar Association  
King County Landmarks Commission  
Pioneer Square Preservation Board

Attached are the responses from each of these groups. The key issues raised in this outreach effort are summarized as follows:

**City Hall Park**

Reclaiming City Hall Park is important to the sense of security, and simply redesigning it will not change County employees' perception that traversing the park is unsafe. There is concern of the ability to renovate and patrol security issues after dark and on weekends. Money should be spent, not in an effort to draw the general public to the space as a "park", but rather in creating the perception of the open space that is primarily reinforcing a "Grande Entrance" to the Courthouse. There is strong support for the idea of returning to the historic design of the entrance and lobby.

**Security/Staffing/Stations**

Reduction of security stations could result in long lines during busy periods; there will always be a need for more than two screening lines during peak times. Improved security may help change the negative perception now associated with the current City Hall Park, and the South Entry project should not be used as justification to reduce security staffing. Moreover, a new City of Seattle Command Center might generate more fire and police presence near the park.

**Loading Dock/Deliveries**

A new loading dock delivery system must include security for both ingress and egress. A security station above the tunnel might create a dual purpose of providing security for the building loading dock facilities as well as for the park. There is also concern that an underground loading dock may not be a feasible way to receive smaller deliveries.

**3rd & 4th Avenue Closures**

Emergency evacuation from the building must be considered (not feasible out of a single exit). There is concern about reasonable waiting time during peak periods if there are only two screening stations focused at the south entrance and one for the tunnel as a result of closing 3rd and 4th Avenues. Keeping them open would help keep those streets activated. Also, if 3rd and 4th Avenues are to be used for exit only, they should still be monitored by security in order to guard against improper entry.

## South Entrance – King County Courthouse Summary of Stakeholder Comments

As a component of Facilities Management Division's, response to Council Ordinance 15333, Section 114, this paper represents a study of the public use, and the impacts to public access of both the reopened south entrance and the potential closure of the east and west entrances. The study was conducted in an outreach method to seek comment from principal user groups of the Courthouse. Stakeholders solicited for comment included those elected officials (other than the Council and Executive) whose public functions are housed in the Courthouse, along with the department agencies located in the building,

### Outreach Groups Presented and Asked for Comment

Superior Court  
District Court  
Prosecuting Attorneys Office  
King County Sheriff  
Office of Civil Rights Enforcement

Department of Judicial Administration  
King County Bar Association  
King County Landmarks Board  
Pioneer Square Historic Board

Presentations to the stakeholders consisted of a short flash video demonstrating the original historic character of the Courthouse in the context of City Hall Park taken from photographs shortly after dedication in 1918, and interior photos of the original entrance with its marble finishes and stairways to the First Floor Lobby and the Second Floor.

Stakeholders were then shown the approximately 80% conceptual design developed as part of the Courthouse Seismic Project in December 2000, before it was eliminated from the project. Details of that design emphasized the overall character of a rehabilitated south entry recalling the original, and design concepts addressing modern requirements for building security, loading dock functions, and integration with City Hall Park. In support of integrating the park, City of Seattle's conceptual plan for City Hall Park, which was designed in 2006 to allow maximum flexibility for new King County south entrance, was also shown.

As a preface to the presentations, stakeholders were encouraged to comment on issues particularly relevant to each group's unique program requirements for use of the Courthouse, as well as general issues of functionality and security. They were also invited to consider the larger perspective of a public space defined by the Courthouse, City Hall Park, the surrounding building and sidewalks, and the space's use by County Employees, and the public.

### **Summary of Stakeholder Comments**

The concept to provide a dignified entrance to Courthouse, to clean-up City Hall Park so that it can be a safe and secure public space for the public and employees was unanimously supported by all groups. Concern about the current condition of City Hall Park was a major concern, with

The concept of reconstituting a new south entrance to the Courthouse, designed with the intent of recalling the historic original entrance to the building, was unanimously supportive.

### **Judge Trickey, writing for Superior Court and the Judges:**

1. Reclaiming City Hall Park important to the sense of security for those who would use the new South Entry.
2. South Entry project should not be used as justification to reduce security staffing. There will always be a need for more than two screening lines during peak times.
3. Restricting access to the ADA elevator to those with disabilities will be difficult. Two escalators would improve the flow, and reduce crowding around the security screening area.
4. There must be a comprehensive access plan for ADA that accounts for drop-off
5. New loading dock delivery system must include a security for both anything coming into the building, and going out.
6. Making 3<sup>rd</sup> and 4<sup>th</sup> Avenues exit only, will still requires security personel to guard against improper entry.

Other: Recommends a study of users who enter the building at various times of the day. Provide counts of strollers, luggage carriers, wheeled cases, hand trucks, etc. as well as those with disabilities.

Escalators: How much remodeling on the second floor will be necessary to accommodate the escalators.

### **Norm Maleng writing for the PAO**

The public perception of City Hall Park is important to the success of a new South Entrance. Money should not be spent in an effort to draw the general public to the space as a "park", but rather the perception of the open space should be primarily that of reinforcing "Grande Entrance to the Courthouse. The function of a public open space to the formal entrance of an important public building is exemplified in the New York City's City Hall.

Security: Improved security may help change the negative perception now associated with the current City Hall Park.

**Susan Rohr, Sheriff, writing for the Sheriff's Office:**

Security: County Employees do not currently feel safe traversing the park in its current state, and simply redesigning it will not change this fact.

The number of security staff does not correlate with the number of entrances, or screening stations. With three stations at the South Entrance functioning at once, a single security assistant (Officer) is insufficient to observe the actions at all three stations.

Emergency evacuation from the building must be considered, and is not feasible out of a single exit. (South Side only)

Recognizing the historic precedence of the Courthouse, security requirements of the current time must also consider adequate space for security functions, including sight lines, and pull-aside inspections in the space.

If 3<sup>rd</sup> and 4<sup>th</sup> Avenues are to be used for Exit Only, they must also be monitored by security personnel because there is no way to guarantee unauthorized, or unscreened entry back into the building, compromising the whole system.

Deliveries: The number and types of deliveries to the building each day are many. The Sheriff's Office receives at least 10 deliveries of documents per day just from the outlying work sites. For heavier packages, the drop-off site must be a reasonable distance. The underground loading dock may not be a feasible way to receive smaller deliveries.

It is imperative that the Sheriff's Court Security Unit be actively involved in the design process.

**Bailey de longh, Office of Civil Rights**

A passenger load/unload zone should be added as close to the building as possible to benefit all visitors, but especially those with disabilities. The existing such zone is along Fourth Avenue.

Provide that the ADA elevator will serve both Floors 1 and 2. ■ It is important to provide adequate space around the screening stations to allow an accessible route to the elevator and escalator(s).

Do not provide amenities such as a pergola, or other features that only benefit those using a non-accessible entry.

There is a significant concern about meeting the waiting periods should the number of screening stations be reduced.

**Barbara Miner, Department of Judicial Administration**

Concern for back-ups at the screening stations at peak times of day should the number of screening stations be reduced from three to two.

There could be a security impact to domestic violence victims as a result of having limited entrances and exits.

District Court staff also suggested that the 3<sup>rd</sup> and 4<sup>th</sup> Avenue entrances be used for exit only, and that the project consider designating a "staff entrance" to facilitate quicker entrance for King County employees.

**King County Bar Association**

A South Entrance would require walking additional distance for those approaching from the north in order to enter the building.

A reduction in the number of screening stations could increase wait times at peak period, which could in turn discourage jurors from serving, and make the Courthouse generally more inconvenient.

If the City of Seattle is unwilling or unable to renovate and patrol City Hall Park, there could be major security issues, especially after dark and on weekends.

**King County Landmarks Commission**

The Landmarks Commission supports the concept of returning the South Entrance to its status as main entrance, and has advocated this opinion since when the idea was studied in 2000 as part of the Courthouse Seismic project.

**Pioneer Square Preservation Board**

The Board expressed support of the concept of reopening the South Entrance and the thought that it would help the City Hall Park by creating a purpose for people to walk through the park, and keep eyes on the park.

Stakeholder Group	City Hall Park / Exterior	Security / Staffing / Stations	ADA Access	Loading Dock / Deliveries	3rd & 4th Ave. Closures	Elevator / Escalators	Drop Off / Pick up	Remodeling Doors	Other
Judge T. Collins Supervisor 2007	Rebuilding City Hall Park important to the success of the Courthouse. The new South Entrance will be used as the new South Entry.	South Entry project should not be used as justification to reduce security staffing. There will always be a need for more than two screening lanes during peak times.	Restricting access to the ADA elevator to those with disabilities will be difficult. Two escalators would mean better flow. There must be a comprehensive access plan for ADA that accounts for drop-off and accessible route.	New loading dock delivery system must include a security for both anything coming into the building, and going out.	Making 3rd and 4th Avenue not only one-way but also require security personnel to guard against improper entry.	How much remodeling on the second floor will be necessary to accommodate the escalators.	The Sheriff's Office receives at least 10 deliveries of documents per day just from the ordinary work sites. For heavier packages, the drop-off site must be a reasonable distance.	It is imperative that the Sheriff's Court Security Unit be actively involved in the design process.	Conduct study of users who enter the building at various times of the day. Provide counts of ambulances, litigation carriers, wheelchairs, hand trucks, etc. as well as those with disabilities.
Norm Matting, PAO	The public perception of City Hall Park is important to the success of a new South Entrance. Money should not be spent in an effort to make the ground public to the space as a park, but rather the space should be primarily for the open space. Entrance to the Courthouse.	Improved security may help change the negative perception associated with the current City Hall Park.		The number and types of deliveries to the building each day are many. The underground loading dock may not be a feasible way to receive smaller deliveries.	Emergency preparation from the building must be considered, such as the ability to exit a single exit. (South Side only) ■ If 3rd and 4th Avenue are to be monitored by security personnel because there is no way to guarantee unscheduled or unannounced entry back into the building, compromising the whole system.				
Stacy Rohn, KC Sheriff	County Employees do not currently feel safe traversing the park in current state, and simply redesigning it will not change that fact.	The number of security staff does not correlate with the number of entrances, or accounting stations. ■ Recognizing the historic precedents of the Courthouse, security requirements of the current time must also consider adequate space for security functions, including sight lines, and public-side inspectors in the space.	Any proposal must meet the needs of persons with disabilities.	Elimination of current loading dock will require thorough analysis of Courthouse delivery needs. ■ District Court uses a daily armored car service. ■ Even small changes to the way items are delivered can have a major impact.	Concerning the 3rd & 4th Avenue intersection, signs only may need to be enhanced to security personnel to avoid people from using someone else's exit for entrance and circumventing the security screening.	The new ADA elevator could impinge upon existing courtroom spaces on the second and potentially Third Floor. This concern is acknowledged because of the current shortage of courtroom, and plans to add one or two new judicial positions. District Court, without a dedicated courtroom for requests, uses Superior Court space on the Third Floor.	Consideration must be given to provide access for court users with large loads and cumbersome trial evidence and exhibits.		
Judge Barbara Lindo, King County District Court	The park does not function as a park because of the its use by transitists, ding & alcohol abusers, and others engaged in illegal activity. ■ The space surrounding the South Entrance should be envisioned as a great "front yard" open and inviting. It must be adequately staffed for security to prevent a return to current illegal uses.	Long lines at security screening points impact Courthouse efficiency, and reducing the number of entrances may cause significant additional peak times during the court day. ■ Adequate security is critical to safe Courthouse that effectively serves its citizens.	Support a design that maintains independence of design with and without disabilities, with particular focus on integration of access routes.		Concern about reasonable waiting time during peak periods. (There are only two screening stations located at the South Entrance and one for the Tunnel as a result of closing 3rd and 4th Avenues).				
Barbara Haver, Judicial Administration	Strong support for idea of returning to the historic design of the entrance and lobby.	Concern for both needs and wait times of screening stations during peak periods. ■ Total number of entrance paths are reduced. ■ Suggestion to make a staff entrance for county employees for quicker entry. ■ Concern for potential contact between victims and defendants in Domestic Violence problems with limited options for entry.	Concern for potential effect on departmental operations due to changes to the loading (unloading) area.	Would prefer to see current 3rd and 4th Avenue entrances maintained as exit doors.			Concern for potential effect on departmental operations due to changes to the loading (unloading) area.		
King County Bar	Concern that inability to renovate and impact City Hall park security issues after dark, and on weekends.	Reduction of security reasons could result in long lines during busy periods, which in turn, could discourage jurors from coming, and which could make the Courthouse generally more inconvenient to use.		Landmarks strongly supports relocation of the loading dock along with a redesign for City Hall Park because of the positive effect upon the urban fabric around the building.	Persons approaching the Courthouse from the North would have to walk further for access.				
King County Landmarks	The potential for the South Entrance project to return the Courthouse's primary entrance to its former grandeur and public use, and to re-establish the relation ship of the building with City Hall Park is tremendous.				This location of the new elevator and stairs, the appropriate finishes, and impacts upon features that have acquire significance since the 1931 addition, must be considered into consideration.				

<p>2007          Pioneer Square Historic Board</p>	<p>The ARC of the PSIB expressed support of the concept to reopen the South Entrance and thought the project would help the park by creating a purpose for parking more cars in the park. The entrance should be integrated with the park.</p>	<p>New City of Seattle Command Center might generate more fire and police presence near the park.</p>	<p>A security station above the tunnel might create a dual purpose of security for the building loading dock facilities, and for the park.</p>	<p>Keeping the 3rd and 5th Avenue entrances open would help keep those streets activated</p>	<p>The ARC of the PSIB questioned the necessity for an escalator, citing that stairs might be more flexible and could handle more people without the problems of maintenance.</p>			
--	--	---	--	--	---	--	--	--



**MICHAEL J. TRICKEY**  
PRESIDING JUDGE OF THE SUPERIOR COURT  
KING COUNTY COURTHOUSE  
516 THIRD AVE.  
SEATTLE, WASHINGTON 98104

**RECEIVED**

**MAR 19 2007**

King County, CPD  
Facilities Management

**March 15, 2007**

**Robert Renouard**  
**Project Manager, LEED**  
**Capital Planning and Development**  
**Facilities Management Division**  
**Department of Executive Services**  
**500 Fourth Avenue, Room 320**  
**Seattle, WA 98104-2337**

**RE: Restoration of South Entrance to King County Courthouse**

**Dear Mr. Renouard:**

**Thank you for this Monday's briefing on the status of the restoration project of the South entrance to the King County Courthouse. I appreciate being asked to submit a letter on behalf of the court summarizing its views on the project.**

**First, it is critical to emphasize that any effort to restore the original south entrance into the courthouse must include reclaiming City Hall Park. Many people, employees and citizens alike, feel unsafe walking through or near the Park. It will be difficult to convince people to use the south entrance if they continue to feel that the Park is dangerous.**

**Second, this project should not, and cannot, be justified as part of an effort to reduce security staffing. Closing other entrances does not mean there should be a reduction in the number of screening lines. There will always be a need for more than two security lines so that the public, including litigants and jurors, can easily enter the courthouse at peak times in the morning and after the lunch hour. We do not want long lines waiting to get into the courthouse during those times.**

**Third, unless you have a staff person "guard" the door, I envision difficulties restricting access to the new elevator to only those with disabilities. The pressure on the single escalator during the peak times in the morning and after lunch will lead folks to search out the elevator. Two escalators would be much better, and keep people flowing into the building rather than congregating around the security stations at the entrance.**

**Fourth, there must be a comprehensive plan for those with disabilities to enter the courthouse. With no ability to drive up and drop people off near an entrance, those with disabilities will struggle getting into the building.**

**Fifth, the elimination of the current loading dock will present challenges for all who make deliveries to the Courthouse. Any new delivery system must include a security component for screening everything coming into the building. Furthermore, the new loading dock must account for things going out of the building. We have judicial rotations yearly with judges and their furnishings moving between the three courthouses.**

**Sixth, it will be difficult to "close" the 3<sup>rd</sup> and 4<sup>th</sup> Avenue entrances and make them "exit only." People will surely try to gain entry to the building as others leave. There will need to be security staff at each entrance to insure that no one enters the building through the "exit."**

**Finally, has anyone done a study of those who enter on 3<sup>rd</sup> or 4<sup>th</sup> Avenue? Do we know the volume at various times of the day? Do we know how many people enter with strollers, luggage carriers, wheeled cases, or hand trucks? I am sure that some of these people as well as others without "disabilities" will need to use the elevator. Will one elevator be sufficient?**

**Sincerely,**

**Judge Michael J. Trickey**



**Cc: Paul Sherfey  
Linda Ridge**

OFFICE OF THE PROSECUTING ATTORNEY  
KING COUNTY, WASHINGTON

2007-0618

Norm Maleng  
Prosecuting Attorney

W400 King County Courthouse  
516 Third Avenue  
Seattle, Washington 98104  
(206) 296-9067  
FAX (206) 296-9013

March 14, 2006

Robert Renouard  
Project Manager  
Facilities Management Division  
500 Fourth Avenue, #320  
Seattle, WA 98104

Dear Robert:

You had asked me for a letter summarizing my comments from our meeting where we discussed the South Entry Project and "City Hall Park". As I shared with you during our meeting, I urge those working on this project to give some thought to what they mean by the term "park". To many, the word "park" conjures up a specific use and image, and most people believe that parks are used by members of the general public.

With regard to the new proposed "City Hall Park", this is not an area that will likely be used by the general public as a park, in the traditional sense of the word. It is more likely that the area South of the Courthouse will be used as open space in conjunction to any new, grand entry to the building.

I would caution anyone working on this project against believing that simply designating the area South of the Courthouse as a park and spending money to spruce up the area will automatically draw members of the public to use it for such. This area is unlikely to draw many who work North of the Courthouse. It may not become the attraction that the project is hoping for.

This area may be better served as part of the "grand entrance" to the Courthouse. If that were the theme of the design for this area, it may reinforce its function as such. Many people who use the Courthouse will pass through this area (assuming that the grand entrance is completed). It should be pleasant, inviting, and functional. In other words, the project could define the users of this proposed "park" area if they were to redefine the "park" as part of the "grand entrance".

If the project considers this approach, it may want to study analogous public buildings that have grand-entry style parks or open space. An example that comes readily to mind is New York City Hall.

My final comment is about security. The project may want to examine what would be the appropriate level of security for this area. Improved security may help change people's perception of this area, and may increase the number of individuals who pass through this area.

Please do not hesitate to contact me if you have any questions regarding my comments or if you would like to discuss this topic further.

Sincerely,



NORM MALENG  
Prosecuting Attorney

# SHERIFF

## KING COUNTY

KING COUNTY SHERIFF'S OFFICE  
516 Third Avenue, W-116  
Seattle, WA 98104-2312  
Tel: 206-296-4155 • Fax: 206-296-0168

Susan L. Rahr  
Sheriff

April 2, 2007

Robert Renouard  
Project Manager  
Facilities Management Division  
500 Fourth Ave. #320  
Seattle, WA 98104

Dear Robert,

You asked me to summarize my comments from our meeting about the "South Entry" project and City Hall Park. Rather than repeating Prosecutor Norm Maleng's and Judge Michael Trickey's comments about the park, I will simply state that I agree with them and add that the employees of the courthouse do not feel safe traversing the park in its current state to enter the courthouse. Simply redesigning the area as a "park" will not change that fact.

With regard to the proposed new south entrance, I will summarize the issues I raised to you in our meeting.

First, and foremost, this new entrance may not reduce the security staffing needs of the courthouse. It is an erroneous assumption that the number of entrances is directly correlated to the number of security staff necessary to safely move people into and out of the courthouse. As we discussed, the more appropriate correlation is the number of people entering and exiting the courthouse. We will need a sufficient number of screening stations to get people into the courthouse in a reasonable amount of time. We already experience backups during the morning rush and lunch hour with two external entrances. If we reduce that to one entrance, we will need to have at least three screening stations at that entrance. For proper operations, each screening station requires three screeners. And with three stations going at once, it is not possible for a single Security Assistant to properly monitor and address safety issues. We must also consider emergency evacuation of the building. It is simply not feasible to accomplish this through a single exit.

I also shared with you my concern that the new south entrance be designed with security in mind. I fully appreciate the wish to respect the history of the building. However, in 2007 we must be mindful of greater security risks as well. The south entrance will need

to be of sufficient size to accommodate three screening stations and allow appropriate line of sight for the security assistants to effectively monitor the activities and have an area to take people aside for additional screening when necessary.

We also discussed whether the current 3<sup>rd</sup> and 4<sup>th</sup> Avenue entrances might be used for "exit only" or for employees. If these entrances are not monitored by security personnel, there is no way to guarantee that people exiting will not inadvertently (or deliberately) allow unauthorized, unscreened access to the building. To do so compromises the entire system.

Another issue that must be addressed is the many, many small deliveries that are made to the courthouse each day. These include carts of documents and other items from King County departments outside the building. For example, the Sheriff's Office alone has over ten deliveries a day of documents, packages of evidence, and other items brought to and from the courthouse just from our outlying work sites. This does not include many deliveries from Fed Ex, UPS, etc. There needs to be parking within a reasonable distance to transport these heavy items. (I don't believe the new underground loading dock is a feasible way to address these smaller deliveries.)

We also discussed the new loading dock concept. Because the design is much less clear I can only comment that there must be a screening process for deliveries, as we have currently. The number of security personnel will depend on the design.

This list of concerns is not exhaustive. As we discussed, it is imperative that a representative from my Court Security Unit be actively involved in the design process for the new entrance and other building entrances. Thoughtful design can certainly reduce the risks, as well as perhaps reduce the number of personnel necessary to ensure the safety of the building. But this will need to be a collaborative process from the start.

I am very willing to assist in any way I can to make the new south entrance project successful. Please do not hesitate to contact me.

Sincerely,

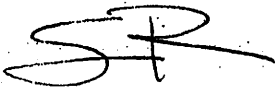

Sue Rahr  
King County Sheriff



## King County

### Office of Civil Rights

Department of Executive Services

400 Yesler Way, Room 260

Seattle, WA 98104-2683

206.296.7592 TTY 206.296.7596

www.metrokc.gov/dias/ocre

DATE: April 4, 2007

TO: Robert Renouard

FROM: Bailey de longh, Director *BdL*  
 Karen Ozmun, Disability Compliance Specialist *ko*

SUBJECT: Courthouse South Entry Project

Thank you for meeting with us on March 14, 2007, regarding this project. We appreciate the opportunity to comment on the existing drawings, and outline some general concerns to be addressed in developing designs.

#### Overview

We strongly encourage a design that maximizes integration of people with and without disabilities, including integration of the accessible route with other routes into and through the courthouse. Where routes may not be integrated due to structural or grading constraints, we strongly support design that will provide equal access.

Feature	Recommendations and Comments
Drop off/pick up	Strongly recommend adding a passenger load/unload zone, which will benefit all visitors to the courthouse, but particularly individuals with disabilities. We recommend that the zone be located as close to the entrance as possible, as people who need to use the passenger load/unload zone often have difficulty navigating distances. The existing passenger load/unload zone is right in front of the 4 <sup>th</sup> Avenue entrance/exit.
Power doors	Strongly recommend installing at least one power door. It is an effective way to ensure compliance when achieving and maintaining door opening force maximum lbs. has historically been a challenge in compliance. Also, even if opening force requirements are met, there are people with disabilities that have difficulty with manual doors due to issues of range of motion, balance, strength and dexterity.



"Commitment to Equality"

King County is an Equal Opportunity Employer and complies with the Americans with Disabilities Act

Power doors help ensure equal access to all members of a diverse community, and reflects current best practices in building design. Power doors have been installed at the existing 3<sup>rd</sup> Avenue entrance, Regional Justice Center, King Street Center, and soon-to-open New County Office Building. (Also, Seattle Justice Center, Seattle City Hall, and Seattle Public Library.)

In addition, power doors are of benefit to individuals with strollers, attorneys with carts carrying trial materials, and delivery services.

- Power door switch** Strongly recommend using a bollard style switch which may be activated at both the maximum height of 36" and at foot pedal height for wheelchair users. Such a switch will be installed at the New County Office Building. Some people with disabilities do not have range of motion or strength to activate standard power door switches, and this switch provides an option to activate with a wheelchair foot pedal.
- Potential switch** Wikk Industries – Ingress'r Tall Switch (planned for NCOB)  
[http://www.wikk.com/sw\\_spec.html](http://www.wikk.com/sw_spec.html)
- Screening stations** Because the south entrance project is an alteration, new construction requirements apply. In our view, all screening stations should meet accessibility requirements, including clear width for magnetometers. Having all screening stations accessible ensures efficient passage for all individuals and integrates people with and without disabilities.
- Benches** Reference: Plan A3.2 dated 12-28-00, F-G/10 and H-K/10  
There are two benches located below wall art. Per code, in our view, we need to provide a wheelchair space in line with these benches, to ensure equal access to sit, alone or next to a friend or colleague, and not be stuck in space intended for pedestrian traffic. [See ICC/ANSI A117.1-2003 903]
- Elevator/escalator** Reference: Plan A3.2 dated 12-28-00, E/10  
Provide an elevator that will serve both floors 1 and 2. Per consultation with U.S. Department of Justice, if technically feasible, we should provide an accessible route to both floors from the entry level, as is provided in non-accessible routes by stairs to floor 1 and by escalator to floor 2.
- Escalator access** Reference: Plan A3.2 dated 12-28-00, E/10  
There appears to be insufficient room between the screening station and access to the escalator. This could result in

restricted movement of visitors at security and/or trying to get to/from the escalator.

No revolving door We strongly support the decision not to use a revolving door at any of the entries to the courthouse, due to accessibility issues.

No pergola Reference: Plan A3.2 dated 12-28-00  
We support the decision not to retain a pergola that provided weather protection only to those who are able to use a non-accessible entrance.

Screening stations Reference: Plan A3.2 dated 12-28-00  
We have significant concern about the planned reduction of total screening stations at entries to the courthouse. Setting aside the Administration Building/tunnel screening station, three major screening stations will be reduced to two. With incoming traffic being focused at one entrance, will two screening stations be functionally adequate and achieve reasonable wait time for visitors when it is busy?





2007-0618

## King County

Department of Judicial Administration

Barbara Miner

Director and Superior Court Clerk

(206) 296-9300 (206) 296-0100 TTY/TDD

RECEIVED

APR 09 2007

King County, CPD  
Facilities Management

April 4, 2007

Robert Renouard, Project Manager  
Capital Planning and Development Section  
Facilities Management Division, DES  
ADM-ES-0320

RE: Courthouse South Entrance Comments

Dear Robert:

Thank you for presenting the South Entrance project information to me. Your presentation was very informative and the project is interesting.

I have shared the information with the staff and management team within the Department of Judicial Administration. Though there was strong support the idea of returning to the historic design of the entrance and lobby areas, there were strong concerns expressed about the implications of the project. Those concerns include:

- The bottleneck that would develop at the security line entrances at peak times of the day due to the reduction in the number of entrance paths. This concern with this issue cannot be stressed enough; the impact is estimated to be very high;
- The potential changes to the loading area and the affect of those changes on departmental operations; and
- The potential security impact of having limited entrances/exits for domestic violence victims. The limited options increase the possibility of contact leading to issues between petitioners and respondents/defendants and victims.

Several suggestions were also offered:

- A suggestion to use the 3<sup>rd</sup>/4<sup>th</sup> avenue doors as at exit doors; and
- A suggestion to make a staff entrance to facilitate quicker entrance for the county employees.

Thank you for the opportunity to provide feedback. Please contact me should you have any questions.

Sincerely,

Barbara Miner  
Director and Superior Court Clerk

**Seattle:**  
516 Third Avenue Room E609  
Seattle, WA 98104-2386

**Regional Justice Center:**  
401 Fourth Avenue North Room 2C  
Kent, WA 98032-4429

**Juvenile Division:**  
1211 East Alder Room 307  
Seattle, WA 98122-5598

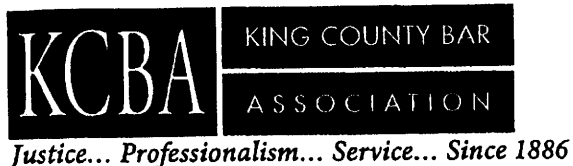

2007-0618

1200 Fifth Avenue, Suite 600  
Seattle, WA 98101

206.267.7100  
206.267.7099 fax

www.kcba.org

APR 16 2007

April 13, 2007

Mr. Robert Renouard  
Capital Project Manager for Capital  
Planning and Development  
King County Department of Executive Services  
500 Fourth Avenue  
Suite 320  
Seattle, WA 98104

Re: Proposal to Reopen South Entrance of King County Courthouse

Dear Robert:

Thank you for your recent presentation to the King County Bar Association Bench-Bar Liaison Committee regarding the proposal to reopen the south entrance of the King County Courthouse.

I was unable to put the proposal before the King County Bar Association Board of Trustees for full consideration at its most recent meeting because of previously scheduled matters that had to be addressed.

I have discussed the proposal informally with members of the Board. They have expressed interest in the plan, insofar as it would restore and showcase the architectural beauty of the original main entrance. Several members expressed concern, however, that the proposal might draw objections from lawyers and from the public for the following reasons:

1. Persons approaching the courthouse from the north would have to walk an additional distance to get to the south side of the courthouse in order to enter the building.
2. If the number of security stations were to be reduced, there could be long lines to get into the courthouse during busy periods, which, in turn, could discourage jurors from serving and which could make the courthouse generally more inconvenient to use.
3. If the City of Seattle is unwilling or unable to renovate and patrol the city park adjacent to the south entrance, there could be major security issues, especially after dark and on weekends.

**OFFICERS**

John R. Ruhl  
President

Eileen M. Concannon  
First Vice-President

Daniel Gandara  
Second Vice-President

Anne M. Daly  
Secretary

James A. Andrus  
Treasurer

**TRUSTEES**

Amelia J. Adair '07

Bonnie J. Glenn '07

Karen W. Murray '07

Jeffrey M. Sakoi '07

Carl E. Forsberg '08

Mark J. Hillman '08

Andrew W. Maron '08

Loretta Sue Story '08

J. Mark Weiss '08

Carlene M. Placide '09

Terence J. Scanlan '09

**ABA DELEGATE**

Peter S. Ehrlichman

**CHAIRPERSON**

**YOUNG LAWYERS**

**DIVISION**

Derek D. Crick

**EXECUTIVE DIRECTOR**

Alice C. Paine

Mr. Robert Renouard  
King County Department of Executive Services  
April 13, 2007  
Page 2

If you wish, I can put this matter on the KCBA Board's agenda for a future meeting, and you can make a full presentation to the Board. In the meantime, I hope that this information is helpful to you in your planning process.

Sincerely,

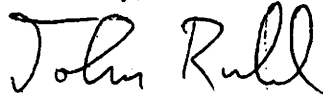

John R. Ruhl

JRR:cls

cc: Alice C. Paine, KCBA Executive Director  
Hon. Michael Trickey

08552299.doc

*draft*

**COMMITTEE BRIEFING**

**King County Courthouse South Entry Rehab**, Seattle, WA  
*Robert Renouard, King County Facilities Management*

Tonie Cook presented information on the proposed 2000 Courthouse Seismic and Additive Alternative Plan that includes rehabilitating the south entrance to the building. She said the portion of the south entrance plan was deferred due to budget and other considerations. She noted two items in the packet: a March 2000 letter, signed by Landmarks Commission Chair Patrick Schneider, and copies of section of a 17-page Executive Summary of the six-volume Facility Program Plan prepared in association with the H3 Facility Project. (See Attachments 1 and 2, dated March and September 2000.) The documents address the south entry and park rehabilitation issues. The Schneider letter articulates the Landmarks Commission's support for the project. Julie Koler said the 1988 Cardwell Study was the initial document that set the stage for on-going discussions about south entrance rehabilitation. She said that over time, however, the plans have changed. Robert Renouard said that the 2000 report represented only 80 percent design and, since that time, changing functions/needs have necessitated revisions to the plan.

Renouard asked the Committee for a letter of support for the project, including members' thoughts on design direction and any other issues of concern. Committee members expressed concern that they are not sufficiently familiar with the project to provide any detailed comments. Renouard then presented current plans for City Hall Park including a new traffic area for vehicle deliveries and pedestrians, elimination of the tunnel and most parking; and then gave an overview of interior elements of the lobby including security stations and escalator. He passed around a water color wash of the proposed south entry. The Committee noted that it contains elements reminiscent of the original 1916 entrance.

The Committee discussed the Cardwell Study; its recommendation to return the south entrance to its original status as main entrance; the current security and operational requirements; the period of significance; determining the new design's compatibility with the historic exterior that does not restore or reconstruct the original exterior; and how to support the current project without adequate review by the full Landmarks Commission. Committee members noted that, unless there have been significant changes to the 2000 schematic plan, there is no reason to think the Commission will not continue its stated support for the direction of the project.

Chair Rich said that a letter from the Commission would be more appropriate than from the DRC and recommended a presentation at the April 26, 2007 meeting, including an overview of the Courthouse. He asked that copies of the Cardwell Study be distributed to commissioners. Tonie Cook offered to provide a copy of the meeting notes to Robert Renouard for use in moving towards a current support letter similar to the 2000 letter from the Landmarks Commission Chair.



The City of Seattle

## Pioneer Square Preservation Board

Mailing Address: PO Box 94649 Seattle WA 98124-4649  
Street Address: 700 5th Ave Suite 1700

PSB 89/07

### ARCHITECTURAL REVIEW COMMITTEE REPORT

From 4/1/07 ARC Meeting for 4/18/07 Board Meeting

Committee Members Present: David Strauss, Sonja Sokol Furesz, Adam Hasson, Lorne McConachie

Board Members Please Note: The citations from the District Ordinance, Rules for the Pioneer Square Preservation District, and Secretary of the Interior's Standards listed below are for your consideration in addition to any other citations you find relevant in considering each application.

#### APPLICATIONS FOR CERTIFICATES OF APPROVAL

041107.11

Trattoria Mitchell

Daniel Mitchell

Travelers Hotel building

84 Yesler Way

Summary of Application:

Signage: Apply business signage to the inside of the windows in black, red and yellow.

ARC Report:

ARC members reviewed the sign renderings, photos and color samples. Mr. Hasson asked if the light fixtures existed or proposed new. Mr. Mitchell, business owner, said they were existing. Mr. Mitchell clarified for the ARC that although the east façade rendering did not show the windows that they would be applied at the same height as shown in the rendering for the Yesler façade. ARC acknowledged that the M, which is a graphic fork design was larger than 10 inches but ARC members thought it could be allowed as part of reduced sign package per the district rules. ARC also thought that it was more like a logo than a letter and the size was okay. ARC recommends approval of the application.

Staff Report: No staff report

Draft Motion: I move to approve a Certificate of Approval for the project as presented per:

Code Citations:

District Rules XX. Rules for Transparency, Signs, Awnings and Canopies

A. Transparency Regulations

C.1. Letter size

SMC 23.66.160 Signs

Administered by The Historic Preservation Program  
The Seattle Department of Neighborhoods

"Printed on Recycled Paper"

041107.12

The Nord Building

Alisha Langston Bond

312 1<sup>st</sup> Ave

## Summary of Application:

Remove and replace existing telephone intercom system.

ARC Report: ARC reviewed the photos, and spec sheets provided. ARC members asked for clarification of the how the installation will affect the brick. Ms. Langston Bond, Pioneer Construction Management, said that the new panel is face mounted so they do not plan to remove any brick. She said they thought that there is existing brick behind the old panel above which would be revealed by the new shorter panel. She said that if they find that the brick is damaged they will replace it in-kind. ARC asked that they specify that in their application. ARC will recommend approval of the application.

Staff Report: Pioneer Construction Management provided confirmation in writing that they will, if necessary, replace any damaged brick in kind.

Draft Motion: I move to approve a Certificate of Approval for the project as presented per:

## Code Citations:

District Rules III General Guidelines for rehabilitation and new construction

SMC 23.66.180 Exterior Design

Secretary of Interior Standards for Rehabilitation 1,2,3,5

041107.13

Main Street Gyros

Tareq Alzer

301 2<sup>nd</sup> Ave Ext S

## Summary of Application:

Street Use: Install a sidewalk café with 2 tables on the Main St. side of the building and 2 tables on the 2<sup>nd</sup> Ave Ext S side of the building.

ARC Report: ARC reviewed the layout, and photos of table and chairs and building as exists. The placement as well as the chairs and tables were found to meet rules. Staff reminded applicant that SDOT also has to approve the tables and chairs on the side walk so they will need to make application with them as well.

## Staff Report:

Draft Motion: I move to approve a Certificate of Approval for the project as presented

per:

## Code Citations:

District Rules XIII Sidewalk cafes

**PRELIMINARY PROJECT REVIEW**

041107.2

King County Courthouse

Robert Renouard

Briefing on possible re-establishment of the south entrance.

ARC Report: Mr. Renouard, Project Manager, King County, FMD gave a briefing on the possibility of re-establishing the south entrance to the King County Courthouse. Mr. Renouard explained that the King County Council had required outreach for the potential project so he is meeting with stakeholders to get initial feedback. The King County Landmarks Board will be reviewing the project. Mr. Renouard showed old pictures of the interior of the lobby and explained that some pieces such as the curved

stairs had been removed. He explained that they found some stairs under the loading dock. Mr. Renouard showed a set of conceptual plans and explained how the new entrance would function. He explained that the other entrances at 3<sup>rd</sup> and 4<sup>th</sup> may be converted to exit only or emergency exits with the security being centralized at the south entrance. Mr. Renouard said they would likely not install the revolving door shown in the plans. ARC members commented that King County may want to study if the escalator is necessary or if the building could be better served by stairs, which may handle more people, be more flexible and breakdown less.

Mr. Renouard explained that the pattern shown on the exterior courtyard is a placeholder still to be determined. Mr. Renouard explained some of the issues that need to be resolved as part of the re-opening of the south entrance. There is mechanical equipment in the court yard. He said they have been able to relocate some of the equipment to other locations while others new location still needs to be determined. In order to re-open the south entrance, the loading dock functions would need to be moved. Mr. Renouard showed ARC a layout of the park and showed the tunnel that accessed the building. He acknowledged that the walls to the tunnel are historic. A security station would need to be at the entrance to the tunnel at the south end of the park but far back enough to not block traffic. Mr. Renouard explained that a shear wall was applied as seismic upgrade but that is now in the way of using one of the lanes. Resolutions they are exploring include making it a controlled one lane tunnel, having some kind of shuttling system or a cut and cover to widen the tunnel. The cut and cover may include a turn around and possible minimal parking. Mr. Renouard said that more parking may be too costly. If the City Hall Park plan is implemented which would convert Dilling Way to a pedestrian path, they would have an additional issue of finding a new location for ADA parking. Attorneys also expressed the desire to have close parking.

ARC members expressed support of the concept of reopening the south entrance and thought that it would help the park by creating a purpose for people to walk through the park and keeping eyes on the park. ARC also expressed that the entrance should be integrated with the park.

Mr. Strauss expressed that he though keeping the 3<sup>rd</sup> and 4<sup>th</sup> Street entrances open would help keep those streets activated. He also thought that if the security station could be located above the tunnel it might create a dual purpose of also providing eyes on the park.

Mr. Hasson pointed out that the new Command Center down the street would create more fire and police traffic by the park. Mr. Hasson expressed that he would like to see what the alternatives were and then could look at it in terms of how it affects historic features and how the historic features could be lease affected.

Mr. McConachie said he would also like to see more details of the alternatives. He would like more information about what exists that is historic, what has been changed and how that evolved. He said with that understanding they could evaluate if it was okay if it was partially restored, better than what is now, but at least the entrance is open.

ARC member mentioned they would like to know more about the current conditions, if there are other original features, particularly on the exterior that exist but are hidden or are there missing architectural features. Mr. Renouard will return to ARC once the alternative plans have further developed.

Issued: May 16, 2007

Genna Nashem

King County Courthouse South Entrance Renovation Report

**Attachment C: King County Department of Executive Services –  
Facilities Management Division**

**Courthouse South Entry Renovation Project**

- **Life Cycle Costs Analysis**



	Option 1 Deputies at 3rd / 4th Ave 4 Hr. Loading Dock	Option 2 Deputies at 3rd / 4th Ave No Loading Dock	Option 3 No Deputies at 3rd / 4th Aven 4 Hr. Loading Dock	Option 4 No Deputies at 3rd / 4th Ave No Loading Dock
3rd and 4th avenue exit staffing	yes	yes	no	no
3rd and 4th Avenue Security Doors Loading Dock	no 4	no 0	yes 4	yes 0
Loading Dock Included	yes	no	yes	no
<b>Comments</b>	<i>Option 3 might have capital impacts on the new KC Admin CIP</i>			
Capital Cost	\$16,500,000	\$8,500,000	\$16,800,000	\$8,900,000
Historic Preservation Grant	(\$800,000)	(\$800,000)	(\$800,000)	(\$800,000)
Annual Staffing Cost	\$123,000	\$3,000	(\$212,000)	(\$265,000)
LCC Capital	\$10,700,000	\$5,300,000	\$10,900,000	\$5,600,000
LCC Staffing	\$1,600,000	\$0	(\$2,700,000)	(\$3,400,000)
Total LCC	\$12,300,000	\$5,300,000	\$8,200,000	\$2,200,000
<b>Notes:</b>	<i>Capital cost assumes 25 year financing at 5% with 6% interim financing and transaction costs</i> <i>LCC Capital includes replacement of elevator and escalators.</i> <i>Staffing costs assume 3% annual inflation on salaries</i> <i>Analysis period is 40 years and use of a 7% real discount rate</i>			
LCC Factor for staffing				\$12.94
LCC factor for capital				63.4%
Add on factor for construction financing and transactions				6%

King County Courthouse South Entrance Renovation Report

**Attachment D: The Robinson Company**

**Courthouse South Entry Renovation Project**

- **Conceptual Design Estimate Summary and**
- **CIP Project Cost Estimate Summaries**



THE  
ROBINSON  
COMPANY

2007-0618

King County Mods			
	LCC Opt. 1	LCC Opt. 2	LCC Opt. 3
SOUTH ENTRY INTERIOR RENOVATION	\$ 3,620,976	\$ 3,620,976	\$ 3,620,976
PEDESTRIAN PLAZA/EXTERIOR WORK	\$ 1,015,963	\$ 1,015,963	\$ 1,015,963
RAMP/LOADING DOCK & TUNNEL	\$ 4,972,712	\$ 4,972,712	0
GENERAL CONDITIONS	\$ 922,527	\$ 922,527	\$ 445,146
<b>SUB-TOTAL</b>	<b>\$ 10,532,178</b>	<b>\$ 10,532,178</b>	<b>\$ 5,082,085</b>
<b>ALTERNATES:</b>			
1 Revolving door exits @ 3RD & 4TH streets	\$ 251,789	\$ 125,895 (a)	\$ 377,684 (b)
2 Additional stop @ new ADA elevator	\$ 62,460	\$ 62,460	\$ 62,460
3 Granite pavers @ 100% of plaza	\$ 77,274	\$ 77,274	\$ 77,274
<b>TOTAL MACC</b>	<b>\$ 11,049,596</b>	<b>\$ 10,797,807</b>	<b>\$ 5,599,503</b>

3rd door added per Sheriff meeting 11/1/07  
Requirement of Historic Grant

EXCLUSIONS:  
STATE SALES TAX  
TESTING AND INSPECTIONS  
CONSTRUCTION CONTINGENCY  
ARCHITECT/ENGINEERING FEES  
PERMITS  
ASBESTOS REMOVAL

Third revolving door at So. Lobby Exit			
	(a)	(b)	Total 3 Doors
\$ 251,789	\$ 125,895	\$ 377,684	\$ 3,620,976
\$ 62,460	\$ 62,460	\$ 62,460	\$ 1,015,963
\$ 77,274	\$ 77,274	\$ 77,274	\$ 4,636,939
			\$ 9,609,651
			9.60%
			\$ 922,527
			\$ 445,146

PARK REDEVELOPMENT/LANDSCAPING CANOPY @ PLAZA SECURITY EQUIPMENT REPROGRAMMING 3RD AVE ENTRANCE TOXIC SOILS/MATERIALS REMOVAL			
	(a)	(b)	Total 3 Doors
\$ 3,620,976	\$ 3,620,976	\$ 3,620,976	\$ 3,620,976
\$ 1,015,963	\$ 1,015,963	\$ 1,015,963	\$ 1,015,963
\$ 4,972,712	\$ 4,972,712	\$ 4,972,712	\$ 4,636,939
\$ 9,609,651	\$ 9,609,651	\$ 9,609,651	\$ 9,609,651
9.60%	9.60%	9.60%	9.60%
\$ 922,527	\$ 922,527	\$ 922,527	\$ 922,527
\$ 445,146	\$ 445,146	\$ 445,146	\$ 445,146

**THE  
ROBINSON  
COMPANY**

**PROJECT:** KING COUNTY COURTHOUSE SOUTH ENTRY RENOVATION - SOUTH ENTRY/LOBBY  
**LOCATION:** SEATTLE, WA  
**BLDG SF:**  
**ESTIMATE:** 2007096  
**EST TYPE:** COST MODEL

<b>DIVISION</b>	<b>DESCRIPTION</b>	<b>TOTAL</b>	<b>\$/SF</b>
A10	FOUNDATIONS	7,500	
B10	SUPERSTRUCTURE	119,310	
B20	EXTERIOR CLOSURE	270,000	
C10	INTERIOR CONSTRUCTION	293,602	
C30	INTERIOR FINISHES	802,208	
D10	CONVEYING SYSTEMS	498,000	
D20	PLUMBING	45,945	
D30	HVAC	117,453	
D40	FIRE PROTECTION	34,155	
D50	ELECTRICAL	280,906	
F20	SELECTIVE BUILDING DEMOLITION	119,500	
<b>ESTIMATE SUBTOTAL</b>		<b>2,588,579</b>	
	DESIGN CONTINGENCY @	12.00%	310,629
	SUBTOTAL		2,899,208
	GENERAL CONTRACTOR'S OH & P @	8.00%	231,937
	SUBTOTAL		3,131,145
	ESCALATION TO 06-JAN-09 (10.00%/YR) @	15.64%	489,831
	<b>TOTAL</b>		<b>3,620,976</b>

**EXCLUSIONS:**  
SEE ESTIMATE SUMMARY

PROJECT: KING COUNTY COURTHOUSE SOUTH ENTRY RENOVATION - SOUTH ENTRY/LOBBY  
 LOCATION: SEATTLE, WA  
 BLDG SF:  
 ESTIMATE: 2007096  
 EST TYPE: COST MODEL

2007-0618

ITEM	DESCRIPTION	QUANTITY	UNIT	UNIT COST	TOTAL	\$/SF
<b>A10 FOUNDATIONS</b>						
03300	ELEVATOR PIT-ADA	1	EA	7,500	7,500	
<b>A10</b>	<b>FOUNDATIONS</b>	<b>DIVISION TOTAL</b>			<b>7,500</b>	
<b>B10 SUPERSTRUCTURE</b>						
03380	ADA ELEV HOIST BEAM	1	LS	2,500	2,500	
03380	CIP BEAMS @ ESCALATOR	1	LS	22,000	22,000	
		LEVEL 1A & 2				
03380	CIP STAIRS TO ELEV LOBBY	176	SF	75.00	13,200	
03380	ELEVATOR RAISED PIT/SLAB	176	SF	180	31,680	
		LEVEL 2				
03380	FLOOR STRUCT @ ESCALATOR	336	SF	45.00	15,120	
		LEVEL 1A				
03380	FLOOR STRUCT TO ADA ELEV.	318	SF	45.00	14,310	
		LEVEL 1				
05510	BRONZE HANDRAILS	46	LF	200	9,200	
05600	BRONZE CLADDING @ ELEV. DOOR	1	LS	1,300	1,300	
		RELOCATE EXISTING				
06110	MISC ROUGH CARPENTRY	1	LS	10,000	10,000	
<b>B10</b>	<b>SUPERSTRUCTURE</b>	<b>DIVISION TOTAL</b>			<b>119,310</b>	
<b>B20 EXTERIOR CLOSURE</b>						
08110	EXT. BRONZE ENTRY DOORS-PR	3	EA	90,000	270,000	
		BALANCED				
<b>B20</b>	<b>EXTERIOR CLOSURE</b>	<b>DIVISION TOTAL</b>			<b>270,000</b>	
<b>C10 INTERIOR CONSTRUCTION</b>						
04220	ELEVATOR CORRIDOR WALLS	756	SF	22.00	16,632	
04220	ELEVATOR MACHINE ROOM WALL	275	SF	22.00	6,050	
04220	ELEVATOR SHAFT WALL	1,242	SF	22.00	27,324	
04220	WALLS @ ESCALATOR	1,770	SF	22.00	38,940	
08110	NEW INT DOOR @ BASEMENT	3	EA	1,800	5,400	
08350	NEW INT DOORS/GLAZING	1	LS	20,000	20,000	
		@ 2ND FLOOR ESCALATOR				
08810	GLAZING @ EXIT VESTIBULE	173	SF	80.00	13,840	
09110	MTL STUD ARCHED SOFFITS	1,064	SF	28.00	29,792	
09110	MTL STUD FLAT SOFFITS	412	SF	18.00	7,416	
09110	MTL STUD FRAME/GWB COLUMNS	2,628	SF	16.00	42,048	
09110	MTL STUD FURR/GWB WALLS	4,320	SF	13.00	56,160	
10000	MISC SPECIALTIES	1	LS	30,000	30,000	
<b>C10</b>	<b>INTERIOR CONSTRUCTION</b>	<b>DIVISION TOTAL</b>			<b>293,602</b>	
<b>C30 INTERIOR FINISHES</b>						

ITEM	DESCRIPTION	QUANTITY	UNIT	UNIT COST	TOTAL	\$/SF
06200	MISC FINISH CPTRY/TRIM	1	LS	35,000	35,000	
06200	RELOCATE SECURITY STATIONS	1	LS	5,000	5,000	
	SCREENWALLS					
06220	EXIT VESTIBULE TRIM	1	LS	6,500	6,500	
06250	GFRG MOULDING/TRIM	1	LS	135,000	135,000	
	INSTALLED					
09220	PREMIUM-VENEER PLASTER	8,424	SF	12.00	101,088	
09310	EXT STONE CLADDING ALLOWANCE	1	LS	35,000	35,000	
09310	MARBLE CLADDING ALLOWANCE	1	LS	362,000	362,000	
09380	ALLOW FOR NEW @ STAIRS	252	SF	60.00	15,120	
09380	ALLOW REPLACE DAMAGED	500	SF	35.00	17,500	
	ASSUME 25%					
09380	RENOVATE EXST'G MARBLE FLOORING	2,000	SF	15.00	30,000	
09900	ALLOW FOR PROTECTION/RELOCATION OF ARTWORK	1	LS	10,000	10,000	
09900	INTERIOR PAINTING ALLOWANCE	1	LS	15,000	15,000	
09900	MISC INT FINISHES	1	LS	35,000	35,000	
<b>C30</b>	<b>INTERIOR FINISHES</b>			<b>DIVISION TOTAL</b>	<b>802,208</b>	
<b>D10</b>	<b>CONVEYING SYSTEMS</b>					
14210	ELEVATOR REWORK @ LOBBY	1	LS	160,000	160,000	
14240	ADA ELEVATOR/2-STOP/2 DOOR	1	EA	68,000	68,000	
14410	ESCALATOR	2	EA	135,000	270,000	
<b>D10</b>	<b>CONVEYING SYSTEMS</b>			<b>DIVISION TOTAL</b>	<b>498,000</b>	
<b>D20</b>	<b>PLUMBING</b>					
15400	PLUMBING	1	LS	45,945	45,945	
<b>D20</b>	<b>PLUMBING</b>			<b>DIVISION TOTAL</b>	<b>45,945</b>	
<b>D30</b>	<b>HVAC</b>					
15700	HVAC	1	LS	117,453	117,453	
<b>D30</b>	<b>HVAC</b>			<b>DIVISION TOTAL</b>	<b>117,453</b>	
<b>D40</b>	<b>FIRE PROTECTION</b>					
15300	FIRE PROTECTION	1	LS	34,155	34,155	
<b>D40</b>	<b>FIRE PROTECTION</b>			<b>DIVISION TOTAL</b>	<b>34,155</b>	
<b>D50</b>	<b>ELECTRICAL</b>					
16000	ELECTRICAL WORK	1	LS	203,532	203,532	
16000	SECURITY SYSTEM WORK	1	LS	77,374	77,374	
<b>D50</b>	<b>ELECTRICAL</b>			<b>DIVISION TOTAL</b>	<b>280,906</b>	
<b>F20</b>	<b>SELECTIVE BUILDING DEMOLITION</b>					
02000	DEMO FLOOR STRUCTURE	1	LS	18,000	18,000	
	@ ESCALATOR					
02000	DEMO-CONC RAMP/DOCK	1	LS	7,500	7,500	
	@ LOBBY					
02000	DEMO-CONC S.O.G.	1	LS	2,500	2,500	

ITEM	DESCRIPTION	QUANTITY	UNIT	UNIT COST	2007 TOTAL	\$/SF
02000	DEMO-STOREFRONT					
			@ ADA ELEV			
02000	MISC. DEMO/PROTECT EXST'G	1	LS	1,500	1,500	
			@ 2ND FLR			
02000	REROUTE MECH FOR ESCALATOR	1	LS	25,000	25,000	
			ALLOW			
02000	REROUTE MECH FOR LOBBY	1	LS	20,000	20,000	
			ALLOW			
02000	SAWCUT DEMO CMU WALLS	1	LS	35,000	35,000	
			ALLOW			
02000	SAWCUT DEMO CMU WALLS	1	LS	10,000	10,000	
<b>F20</b>	<b>SELECTIVE BUILDING DEMOLITION</b>			<b>DIVISION TOTAL</b>	<b>119,500</b>	
<b>ESTIMATE SUBTOTAL</b>					<b>2,588,579</b>	



**THE  
ROBINSON  
COMPANY**

**PROJECT:** KING COUNTY COURTHOUSE SOUTH ENTRY RENOVATION - PEDESTRIAN PLAZA/ EXTERIOR WORK  
**LOCATION:** SEATTLE, WA  
**BLDG SF:**  
**ESTIMATE:** 2007096  
**EST TYPE:** COST MODEL

<b>DIVISION</b>	<b>DESCRIPTION</b>		<b>TOTAL</b>	<b>\$/SF</b>
B20	EXTERIOR CLOSURE		291,945	
D20	PLUMBING		9,412	
D50	ELECTRICAL		111,811	
G10	SITE PREPARATION		77,375	
G20	SITE IMPROVEMENTS		210,753	
G30	SITE CIVIL / MECHANICAL UTILITIES		25,000	
<b>ESTIMATE SUBTOTAL</b>			<b>726,296</b>	
	DESIGN CONTINGENCY @	12.00%	87,156	
	SUBTOTAL		813,452	
	GENERAL CONTRACTOR'S OH & P @	8.00%	65,076	
	SUBTOTAL		878,528	
	ESCALATION TO 06-JAN-09 (10.00%/YR) @	15.64%	137,435	
<b>TOTAL</b>			<b>1,015,963</b>	

**EXCLUSIONS:**

SEE ESTIMATE SUMMARY



**PROJECT:** KING COUNTY COURTHOUSE SOUTH ENTRY RENOVATION - PEDESTRIAN PLAZA/ EXTERIOR WORK 2007-0618  
**LOCATION:** SEATTLE, WA  
**BLDG SF:**  
**ESTIMATE:** 2007096  
**EST TYPE:** COST MODEL

ITEM	DESCRIPTION	QUANTITY	UNIT	UNIT COST	TOTAL	\$/SF
<b>B20 EXTERIOR CLOSURE</b>						
04850	SEISMIC PINNING @ MASONRY		1 LS	135,000	135,000	
						ALLOW
04910	CRACK REPAIR ALLOWANCE	32,250	SFA	1.50	48,375	
04910	TUCKPOINT MASONRY	8,062	SF	10.00	80,620	
						ASSUMING 25%
04930	CLEAN/SEAL EXT. MASONRY	13,975	SF	2.00	27,950	
<b>B20</b>	<b>EXTERIOR CLOSURE</b>			<b>DIVISION TOTAL</b>	<b>291,945</b>	
<b>D20 PLUMBING</b>						
15400	PLUMBING/DRAINAGE ALLOWANCE		1 LS	9,412	9,412	
<b>D20</b>	<b>PLUMBING</b>			<b>DIVISION TOTAL</b>	<b>9,412</b>	
<b>D50 ELECTRICAL</b>						
16000	SECURITY SYSTEMS/CAMERAS		1 LS	35,000	35,000	
						ALLOW
16000	SITE LIGHTING ALLOWANCE		1 LS	76,811	76,811	
<b>D50</b>	<b>ELECTRICAL</b>			<b>DIVISION TOTAL</b>	<b>111,811</b>	
<b>G10 SITE PREPARATION</b>						
02000	ALLOW-RELOCATE MECH EQUIP		1 LS	35,000	35,000	
02000	DEMO-CONC SLAB @ PLAZA	3,650	SF	7.50	27,375	
02000	MISC. SITE DEMOLITION		1 LS	10,000	10,000	
02000	SAWCUTTING ALLOWANCE		1 LS	5,000	5,000	
<b>G10</b>	<b>SITE PREPARATION</b>			<b>DIVISION TOTAL</b>	<b>77,375</b>	
<b>G20 SITE IMPROVEMENTS</b>						
02620	DRAINAGE MEMBRANE SYSTEM	3,650	SF	7.50	27,375	
02755	CONC LIGHT BASES	12	EA	1,200	14,400	
02775	CONC SLAB @ PLAZA/SUB-BASE	3,650	SF	10.00	36,500	
02780	CONC PAVERS @ PLAZA	1,674	SF	22.00	36,828	
02780	STONE PAVERS @ PLAZA/ENTRY RAMP	630	SF	55.00	34,650	
02800	REPAIR GRANITE PILLARS	2	EA	2,500	5,000	
02820	ARCH SCREENWALLS-ALLOW	150	LF	210	31,500	
02830	CONC PLANTER/SEAT WALLS	6	EA	3,500	21,000	
10350	FLAGPOLE W/BASE		1 EA	3,500	3,500	
<b>G20</b>	<b>SITE IMPROVEMENTS</b>			<b>DIVISION TOTAL</b>	<b>210,753</b>	
<b>G30 SITE CIVIL / MECHANICAL UTILITIES</b>						
02630	STORM DRAINAGE ALLOWANCE		1 LS	25,000	25,000	
<b>G30</b>	<b>SITE CIVIL / MECHANICAL UTILITIES</b>			<b>DIVISION TOTAL</b>	<b>25,000</b>	

ITEM	DESCRIPTION	QUANTITY	UNIT	UNIT COST	TOTAL	\$/SF
ESTIMATE SUBTOTAL					726,296	



THE  
ROBINSON  
COMPANY

2007-0618

**PROJECT:** KING COUNTY COURTHOUSE SOUTH ENTRY RENOVATION - RAMP/LOADING DOCK & TUNNEL  
**LOCATION:** SEATTLE, WA  
**BLDG SF:**  
**ESTIMATE:** 2007096  
**EST TYPE:** COST MODEL

DIVISION	DESCRIPTION	TOTAL	\$/SF
A10	FOUNDATIONS	406,146	
A20	BASEMENT CONSTRUCTION	1,008,391	
B20	EXTERIOR CLOSURE	58,020	
C10	INTERIOR CONSTRUCTION	81,160	
C30	INTERIOR FINISHES	5,000	
D20	PLUMBING	54,198	
D30	HVAC	60,239	
D40	FIRE PROTECTION	131,497	
D50	ELECTRICAL	266,830	
E10	EQUIPMENT	42,000	
E20	FURNISHINGS	5,000	
G10	SITE PREPARATION	1,000,560	
G20	SITE IMPROVEMENTS	388,373	
G30	SITE CIVIL / MECHANICAL UTILITIES	40,000	
G90	OTHER SITE CONSTRUCTION	7,500	
<b>ESTIMATE SUBTOTAL</b>		<b>3,554,914</b>	
	DESIGN CONTINGENCY @	12.00%	426,590
	SUBTOTAL		3,981,503
	GENERAL CONTRACTOR'S OH & P @	8.00%	318,520
	SUBTOTAL		4,300,023
	ESCALATION TO 06-JAN-09 (10.00%/YR) @	15.64%	672,689
	<b>TOTAL</b>		<b>4,972,712</b>

**EXCLUSIONS:**

SEE ESTIMATE SUMMARY

**PROJECT:** KING COUNTY COURTHOUSE SOUTH ENTRY RENOVATION - RAMP/LOADING DOCK & TUNNEL 2007-0618  
**LOCATION:** SEATTLE, WA  
**BLDG SF:**  
**ESTIMATE:** 2007096  
**EST TYPE:** COST MODEL

ITEM	DESCRIPTION	QUANTITY	UNIT	UNIT COST	TOTAL	\$/SF
<b>A10 FOUNDATIONS</b>						
02315	FNDTN EXCVTE/BACKFILL	14,326	SFA	4.00	57,304	
02480	UNDERPIN EX' STNG RET. WALL	265	LF	185	49,025	
02740	ASPHALT OVERLAY	14,326	SF	1.50	21,489	
03300	CONC BASE SLAB/GRAVEL- 6"	14,326	SF	8.00	114,608	
03300	FOOTINGS/FOUNDATIONS	14,326	SFA	10.00	143,260	
03300	RAISED LOADING DOCK/RAMP PREMIUM	1,490	SF	10.00	14,900	
07100	FOOTING DRAINAGE	556	LF	10.00	5,560	
<b>A10</b>	<b>FOUNDATIONS</b>			<b>DIVISION TOTAL</b>	<b>406,146</b>	
<b>A20 BASEMENT CONSTRUCTION</b>						
03310	CIP CONC COLUMNS- 30" DIA	80	LF	260	20,800	
03310	CIP TUNNEL WALL- 1'4"	10,564	SF	35.00	369,740	
03310	TUNNEL CONC LID STRUCTURE	14,326	SF	36.00	515,736	
03930	WORK @ TRANSITION TO EXISTING TUNNEL	1	LS	15,000	15,000	
			ALLOW			
07100	DRAINAGE MEMBRANE @ WALLS/LID	24,890	SF	3.50	87,115	
<b>A20</b>	<b>BASEMENT CONSTRUCTION</b>			<b>DIVISION TOTAL</b>	<b>1,008,391</b>	
<b>B20 EXTERIOR CLOSURE</b>						
03370	AIR DISCHARGE STRUCTURE/LOUVERS	1	LS	19,020	19,020	
			ALLOW			
08330	COILING DOORS	2	EA	12,000	24,000	
09220	EXT FINISH @ TUNNEL ENTRANCE	1	LS	15,000	15,000	
			ALLOW			
<b>B20</b>	<b>EXTERIOR CLOSURE</b>			<b>DIVISION TOTAL</b>	<b>58,020</b>	
<b>C10 INTERIOR CONSTRUCTION</b>						
04220	INT. CMU PLAIN 8"-SOLID GROUT	3,230	SF	22.00	71,060	
08110	INT. H.M. DOOR/FRM/HDWRE-SGL	3	LVS	1,200	3,600	
08110	INT. H.M. RELITE/GLAZING	3	EA	500	1,500	
10000	MISC SPECIALTIES	1	LS	5,000	5,000	
<b>C10</b>	<b>INTERIOR CONSTRUCTION</b>			<b>DIVISION TOTAL</b>	<b>81,160</b>	
<b>C30 INTERIOR FINISHES</b>						
06200	MISC. FINISHES/TRIM	1	LS	5,000	5,000	
<b>C30</b>	<b>INTERIOR FINISHES</b>			<b>DIVISION TOTAL</b>	<b>5,000</b>	
<b>D20 PLUMBING</b>						
15400	PLUMBING	1	LS	54,198	54,198	
<b>D20</b>	<b>PLUMBING</b>			<b>DIVISION TOTAL</b>	<b>54,198</b>	

ITEM	DESCRIPTION	QUANTITY	UNIT	UNIT COST 2007	TOTAL \$	/SF
<b>D30 HVAC</b>						
15700	HVAC WORK	1	LS	60,239	60,239	
<b>D30</b>	<b>HVAC</b>	<b>DIVISION TOTAL</b>			<b>60,239</b>	
<b>D40 FIRE PROTECTION</b>						
15300	FIRE PROTECTION	1	LS	131,497	131,497	
<b>D40</b>	<b>FIRE PROTECTION</b>	<b>DIVISION TOTAL</b>			<b>131,497</b>	
<b>D50 ELECTRICAL</b>						
16000	ELECTRICAL WORK	1	LS	239,000	239,000	
16000	SECURITY SYSTEMS	1	LS	27,830	27,830	
<b>D50</b>	<b>ELECTRICAL</b>	<b>DIVISION TOTAL</b>			<b>266,830</b>	
<b>E10 EQUIPMENT</b>						
11000	MISC EQUIPMENT ALLOWANCE	1	LS	10,000	10,000	
11160	TRUCK DOCK LEVELER	4	EA	8,000	32,000	
<b>E10</b>	<b>EQUIPMENT</b>	<b>DIVISION TOTAL</b>			<b>42,000</b>	
<b>E20 FURNISHINGS</b>						
12320	CASEWORK/SHELVING ALLOWANCE	1	LS	5,000	5,000	
<b>E20</b>	<b>FURNISHINGS</b>	<b>DIVISION TOTAL</b>			<b>5,000</b>	
<b>G10 SITE PREPARATION</b>						
02000	ALLOW-REWORK @ FUEL TANK	1	LS	15,000	15,000	
02000	DEMO/SALVAGE BRICK PAVERS	2,700	SF	2.50	6,750	
02000	DEMO-ASPHALT @ FIRE LANE	2,550	SF	5.00	12,750	
02000	DEMO-EXISTING TUNNEL STRUCTURE	1	LS	40,000	40,000	
02000	MISC SAWCUT/PROTECT EXST'G	1	LS	10,000	10,000	
02000	REMOVE ROLLUP DOORS	2	EA	500	1,000	
02000	SITE DEMO ALLOWANCE	57,000	SFA	1.00	57,000	
02250	SHORING ALLOWANCE (2 SIDES)	5,282	SF	55.00	290,510	
02315	BACKFILL @ TUNNEL-FROM STOCKPILE	7,200	CY	15.00	108,000	
02315	EXCAVATE/STOCKPILE FOR TUNNEL/RAMP	15,600	CY	18.00	280,800	
02315	RAISE SITE WITH STOCKPILED SOIL	8,400	CY	15.00	126,000	
02335	GRADE/COMPACT SITE	57,000	SF	0.75	42,750	
02370	EROSION CONTROL	1	LS	10,000	10,000	
<b>G10</b>	<b>SITE PREPARATION</b>	<b>DIVISION TOTAL</b>			<b>1,000,560</b>	
<b>G20 SITE IMPROVEMENTS</b>						
02740	REPAVE FIRE LANE	2,550	SF	6.75	17,213	
02780	RESET BRICK PAVERS, GROUTED	2,700	SF	9.00	24,300	
02820	ALLOW-RENOVATE SITE STAIR	1	LS	7,500	7,500	
02820	RENOVATE EXISTING CONC/BRICK WALL	180	LF	300	54,000	
02830	RETAINING WALLS @ RAMP	3,840	SF	45.00	172,800	
02830	SITE RETAINING WALLS	804	LF	140	112,560	

ITEM	DESCRIPTION	QUANTITY	UNIT	UNIT COST	2007 TOTAL	\$/SF
<b>G20</b>	<b>SITE IMPROVEMENTS</b>				<b>DIVISION TOTAL</b>	<b>388,373</b>
<b>G30</b>	<b>SITE CIVIL / MECHANICAL UTILITIES</b>					
02630	STORM COLLECTION/DRAINAGE	1	LS	40,000	40,000	
					ALLOW	
<b>G30</b>	<b>SITE CIVIL / MECHANICAL UTILITIES</b>				<b>DIVISION TOTAL</b>	<b>40,000</b>
<b>G90</b>	<b>OTHER SITE CONSTRUCTION</b>					
02770	CURBS	300	LF	25.00	7,500	
<b>G90</b>	<b>OTHER SITE CONSTRUCTION</b>				<b>DIVISION TOTAL</b>	<b>7,500</b>
					<b>ESTIMATE SUBTOTAL</b>	<b>3,554,914</b>

PROJECT: KING COUNTY COURTHOUSE SOUTH ENTRY RENOVATION  
 LOCATION: SEATTLE, WA  
 ESTIMATE: 2007096  
 EST TYPE: COST MODEL

2007-0618

**ALT # 1**  
**REVOLVING DOORS @ 3RD/4TH ST. EXITS**

ITEM	DESCRIPTION	QUANTITY	UNIT	UNIT COST	TOTAL
05100	STRUCTURE FRAME AROUND DOORS	2	LS	7,500	15,000
			ALLOW		
08340	REVOLVING DOORS	2	EA	70,000	140,000
09250	WALL/FINISHES AROUND DOOR	2	LS	12,500	25,000
			ALLOW		
		ALTERNATE SUBTOTAL			180,000
		MARKUP @			39.9%
		TOTAL			251,789

**ALT # 2**  
**ADDITIONAL STOP @ ADA ELEVATOR**

ITEM	DESCRIPTION	QUANTITY	UNIT	UNIT COST	TOTAL
04220	ELEVATOR SHAFT WALL	666	SF	22.00	14,652
09380	DEMO/REPLACE WALLS & FINISHES	1	LS	20,000	20,000
			ALLOW		
14240	ADA ELEVATOR-ADDITIONAL STOP	1	LS	10,000	10,000
		ALTERNATE SUBTOTAL			44,652
		MARKUP @			39.9%
		TOTAL			62,460

**ALT # 3**  
**USE GRANITE @ ALL INFILL PANELS @ PLAZA**

ITEM	DESCRIPTION	QUANTITY	UNIT	UNIT COST	TOTAL
02780	CONC PAVERS @ PLAZA	-1,674	SF	22.00	-36,828
02780	GRANITE PAVERS @ PLAZA/ENTRY RAMP	1,674	SF	55.00	92,070
		ALTERNATE SUBTOTAL			55,242
		MARKUP @			39.9%
		TOTAL			77,274

# 2008 CIP PROJECT COST ESTIMATE SUMMARY

## DESIGN DEVELOPMENT OPTION - 1

Project Name: Courthouse South Entry CIP Number: \_\_\_\_\_ Date: 1-Nov-07

Requesting Agency: \_\_\_\_\_ Estimator: Seneca - FMD  
 Implementing Agency: \_\_\_\_\_ Checked by: \_\_\_\_\_

Project Scope: This project restores the south entry as the primary entrance to the Courthouse. An underground loading facility will be constructed at the Jefferson Street ROW face of the exiting tunnel to accommodate loading functions. The park will be redone and funded by the City of Seattle. New security entry point equipment is included - it is assumed the 3rd and 4th Avenue entrances will become exit only. No new exit only doors are included for the existing 3rd and 4th Avenue, but one is included for the new South Lobby exit. Also included is the an ADA Elevator to the 2nd Floor, and Granite Paving in the Plaza

ELEMENT - DESCRIPTION	TOTAL PROJECT COST	2008 PROJECT REQUEST
<b>001 - CONSULTANT DESIGN</b>		
Basic A/E Fee	\$978,000	\$0
Landmark Commission preparation & review	inc	_____
Security Consultant	inc	_____
Elevator Consultant	inc	_____
Grading Permit/SWM Drainage Review	na	_____
Level II Drainage Tech. Report	na	_____
Soils Testing	\$10,000	_____
Outside Survey	na	_____
Consultant Selection Advertisement Costs	inc	_____
PCSP Division Costs (Procurement)	_____	_____
Asbestos Assessment	\$5,000	_____
Other Design	_____	_____
<b>Total 001 - Consultant Design Cost</b>	<b>\$993,000</b>	<b>\$993,000</b>
<b>003 - CONSTRUCTION</b>		
MAX. ALLOWABLE CONST. COST (MACC)	\$ 10,797,807	\$0
Sales Tax.....( 8.90% )of MACC	\$961,005	\$0
Building Permit Fees..( 2.00% )of MACC	\$215,958	\$0
Data Communications Costs	\$8,000	\$0
Telephone Cost (\$350/phone)	\$950	_____
Relocation/Temporary Construction Cost	\$50,000	_____
Security Cost during Construction (required for work in CH, RJC & KCCF)	\$60,000	_____
Artist Designs & Implementation (applicable WSST included)	_____	\$0
Moving Cost	\$10,000	_____
PCSP Division review and Bid Advertisement Costs	_____	_____
Printing Cost (Bid Documents)	\$20,000	_____
Special Inspection & Testing Fee	\$50,000	_____
<b>Total 003 - Construction Cost</b>	<b>\$12,173,718</b>	<b>\$12,173,718</b>
<b>004 - EQUIPMENT &amp; FURNISHINGS</b>		
Total 004 - Equipment & Furnish. Cost	\$328,142	\$328,142
Miscellaneous	0	_____
<b>005 - CONTINGENCY</b>		
Project Conting. ( 15.00% ) of 001, 003, 004, 007, & 009	_____	_____
<b>Total 005 - Contingency Cost</b>	<b>\$2,086,479</b>	<b>\$2,086,479</b>
<b>007 - COUNTY FORCE DESIGN</b>		
Project Design ( of 001, 003, 004)	_____	_____
Other	\$0	\$0
<b>Total 007 - CONTRACTED CONST. MGMT.</b>	<b>\$400,000</b>	<b>\$400,000</b>
<b>009 - COUNTY FORCE ADMINISTRATION</b>		
GGCIP Project Mgmt Hours <span style="border: 1px solid black; padding: 2px;">150</span>	_____	_____
<b>Total 009 - County Force Admin. Cost</b>	<b>\$15,000</b>	<b>\$15,000</b>
<b>006 - ART (1% of 001,003,005,007 &amp; 009)</b>	<b>\$156,682</b>	<b>\$156,682</b>
<b>010 - ADMINISTRATIVE OH ( 2.00% of total project cost)</b>	<b>\$323,060</b>	<b>\$323,060</b>
<b>TOTAL PROJECT COST</b>	<b>\$16,476,081</b>	<b>\$16,476,081</b>
Less Existing Funds:	0	_____
<b>2008 PROJECT REQUEST</b>	<b>\$16,476,081</b>	<b>\$16,476,081</b>

### SOURCE OF FUNDING



## 2008 CIP PROJECT COST ESTIMATE SUMMARY DESIGN DEVELOPMENT OPTION - 2

Project Name: Courthouse South Entry CIP Number: \_\_\_\_\_ Date: 1-Nov-07

Requesting Agency: \_\_\_\_\_ Estimator: Seneca - FMD

Implementing Agency: \_\_\_\_\_ Checked by: \_\_\_\_\_

Project Scope: This project restores the south entry as the primary entrance to the Courthouse. No loading dock is constructed and there are no improvements to the existing tunnel. The park will be redone and funded by the City of Seattle. New security entry point equipment is included - it is assumed the 3rd and 4th Avenue entrances will become exit only. Existing doors at 3rd & 4th Avenues remain, and there is a new exit only door are for the new South Lobby exit only. Also included is the an ADA Elevator to the 2nd Floor, and Granite Paving in the Plaza.

ELEMENT - DESCRIPTION	TOTAL PROJECT COST	2008 PROJECT REQUEST
<b>001 - CONSULTANT DESIGN</b>		
Basic A/E Fee	\$480,000	\$0
Landmark Commission preparation & review	inc	
Security Consultant	inc	
Elevator Consultant	inc	
Grading Permit/SWM Drainage Review	na	
Level II Drainage Tech. Report	na	
Soils Testing	\$0	
Outside Survey	na	
Consultant Selection Advertisement Costs	inc	
PCSP Division Costs (Procurement)		
Asbestos Assessment	\$5,000	
Other Design		
<b>Total 001 - Consultant Design Cost</b>	<b>\$485,000</b>	<b>\$485,000</b>
<b>003 - CONSTRUCTION</b>		
MAX. ALLOWABLE CONST. COST (MACC)	\$ 5,347,714	\$0
Sales Tax.....( 8.90% )of MACC	\$475,947	\$0
Building Permit Fees..( 2.00% )of MACC	\$108,954	\$0
Data Communications Costs	\$8,000	\$0
Telephone Cost (\$350/phone)	\$950	
Relocation/Temporary Construction Cost	\$25,000	
Security Cost during Construction (required for work in CH, RJC & KCCF)	\$60,000	
Artist Designs & Implementation (applicable WSST included)		\$0
Moving Cost	\$10,000	
PCSP Division review and Bid Advertisement Costs		
Printing Cost (Bid Documents)	\$20,000	
Special Inspection & Testing Fee	\$25,000	
<b>Total 003 - Construction Cost</b>	<b>\$6,079,565</b>	<b>\$6,079,565</b>
<b>004 - EQUIPMENT &amp; FURNISHINGS</b>		
<b>Total 004 - Equipment &amp; Furnish. Cost</b>	<b>\$328,142</b>	<b>\$328,142</b>
Miscellaneous	0	
<b>005 - CONTINGENCY</b>		
Project Conting. ( 15.00% ) of 001, 003, 004, 007, & 009		
<b>Total 005 - Contingency Cost</b>	<b>\$1,080,031</b>	<b>\$1,080,031</b>
<b>007 - COUNTY FORCE DESIGN</b>		
Project Design ( of 001, 003, 004)		
Other	\$0	\$0
<b>Total 007 - CONTRACTED CONST. MGMT.</b>	<b>\$300,000</b>	<b>\$300,000</b>
<b>009 - COUNTY FORCE ADMINISTRATION</b>		
GGCIP Project Mgmt Hours <span style="border: 1px solid black; padding: 2px;">150</span>		
<b>Total 009 - County Force Admin. Cost</b>	<b>\$7,500</b>	<b>\$7,500</b>
<b>006 - ART (1% of 001,003,005,007 &amp; 009)</b>	<b>\$79,521</b>	<b>\$79,521</b>
<b>010 - ADMINISTRATIVE OH ( 2.00% of total project cost)</b>	<b>\$167,195</b>	<b>\$167,195</b>
<b>TOTAL PROJECT COST</b>	<b>\$8,526,954</b>	<b>\$8,526,954</b>
Less Existing Funds:	0	
<b>2008 PROJECT REQUEST</b>		<b>\$8,526,954</b>

**2008 CIP PROJECT COST ESTIMATE SUMMARY**

2007-0618

**DESIGN DEVELOPMENT OPTION - 3**

Project Name:	Courthouse South Entry	CIP Number:		Date:	2-Nov-07
Requesting Agency:		Estimator:	Seneca - FMD		
Implementing Agency:		Checked by:			

**Project Scope:** This project restores the south entry as the primary entrance to the Courthouse. An underground loading facility will be constructed at the Jefferson Street ROW face of the exiting tunnel to accommodate loading functions. The park will be redone and funded by the City of Seattle.  
 New security entry point equipment is included - it is assumed the 3rd and 4th Avenue entrances will become exit only. New exit only doors are included for the existing 3rd and 4th Avenue, and the new South Lobby exit. Also included is the an ADA Elevator to the 2nd Floor, and Granite Paving in the Plaza

ELEMENT - DESCRIPTION	TOTAL PROJECT COST	2008 PROJECT REQUEST
<b>001 - CONSULTANT DESIGN</b>		
Basic A/E Fee	\$978,000	
Landmark Commission preparation & review	inc	
Security Consultant	inc	
Elevator Consultant	inc	
Grading Permit/SWM Drainage Review	na	
Level II Drainage Tech. Report	na	
Soils Testing	\$10,000	
Outside Survey	na	
Consultant Selection Advertisement Costs	inc	
PCSP Division Costs (Procurement)		
Asbestos Assessment	\$5,000	
Other Design		
<b>Total 001 - Consultant Design Cost</b>	<b>\$993,000</b>	<b>\$993,000</b>
<b>003 - CONSTRUCTION</b>		
MAX. ALLOWABLE CONST. COST (MACC)	\$ 11,049,596	
Sales Tax.....( 8.90% )of MACC	\$983,414	
Building Permit Fees.( 2.00% )of MACC	\$220,992	
Data Communications Costs	\$8,000	
Telephone Cost (\$350/phone)	\$950	
Relocation/Temporary Construction Cost	\$50,000	
Security Cost during Construction (required for work in CH, RJC & KCCF)	\$60,000	
Artist Designs & Implementation (applicable WSST included)		
Moving Cost	\$10,000	
PCSP Division review and Bid Advertisement Costs		
Printing Cost (Bid Documents)	\$20,000	
Special Inspection & Testing Fee	\$50,000	
<b>Total 003 - Construction Cost</b>	<b>\$12,452,952</b>	<b>\$12,452,952</b>
<b>004 - EQUIPMENT &amp; FURNISHINGS</b>		
<b>Total 004 - Equipment &amp; Furnish. Cost</b>	<b>\$328,142</b>	<b>\$328,142</b>
Miscellaneous	0	
<b>005 - CONTINGENCY</b>		
Project Conting. ( 15.00% ) of 001, 003, 004, 007, & 009		
<b>Total 005 - Contingency Cost</b>	<b>\$2,128,384</b>	<b>\$2,128,384</b>
<b>007 - COUNTY FORCE DESIGN</b>		
Project Design ( of 001, 003, 004)		
Other		
<b>Total 007 - CONTRACTED CONST. MGMT.</b>		
Includes cost estimating	\$400,000	\$400,000
<b>009 - COUNTY FORCE ADMINISTRATION</b>		
GGCIP Project Mgmt Hours 150	\$15,000	\$15,000
<b>Total 009 - County Force Admin. Cost</b>		
<b>006 - ART (1% of 001,003,005,007 &amp; 009)</b>	<b>\$159,893</b>	<b>\$159,893</b>
<b>010 - ADMINISTRATIVE OH ( 2.00% of total project cost)</b>	<b>\$329,547</b>	<b>\$329,547</b>
<b>TOTAL PROJECT COST</b>	<b>\$16,806,898</b>	<b>\$16,806,898</b>
Less Existing Funds:		
<b>2008 PROJECT REQUEST</b>		<b>\$16,806,898</b>
<b>SOURCE OF FUNDING</b>		
<b>TOTAL</b>		

# 2008 CIP PROJECT COST ESTIMATE SUMMARY

2007-0618

## DESIGN DEVELOPMENT OPTION - 4

Project Name:	Courthouse South Entry	CIP Number:	Date:	1-Nov-07
Requesting Agency:		Estimator:	Seneca - FMD	
Implementing Agency:		Checked by:		
Project Scope:	This project restores the south entry as the primary entrance to the Courthouse. No loading dock is constructed and there are no improvements to the existing tunnel. The park will be redone and funded by the City of Seattle. New security entry point equipment is included - it is assumed the 3rd and 4th Avenue entrances will become exit only. New exit only doors are included for the 3rd and 4th Avenue entrances, and the new South Lobby exit. Also included is the an ADA Elevator to the 2nd Floor, and Granite Paving in the Plaza.			

ELEMENT - DESCRIPTION	TOTAL PROJECT COST	2008 PROJECT REQUEST
<b>001 - CONSULTANT DESIGN</b>		
Basic A/E Fee	\$480,000	
Landmark Commission preparation & review	inc	
Security Consultant	inc	
Elevator Consultant	inc	
Grading Permit/SWM Drainage Review	na	
Level II Drainage Tech. Report	na	
Soils Testing		
Outside Survey	na	
Consultant Selection Advertisement Costs	inc	
PCSP Division Costs (Procurement)		
Asbestos Assessment	\$5,000	
Other Design		
<b>Total 001 - Consultant Design Cost</b>	<b>\$485,000</b>	<b>\$485,000</b>
<b>003 - CONSTRUCTION</b>		
MAX. ALLOWABLE CONST. COST (MACC)	\$ 5,599,503	
Sales Tax.....( 8.90% ) of MACC	\$498,356	
Building Permit Fees..( 2.00% ) of MACC	\$111,990	
Data Communications Costs	\$8,000	
Telephone Cost (\$350/phone)	\$950	
Relocation/Temporary Construction Cost	\$25,000	
Security Cost during Construction (required for work in CH, RJC & KCCF)	\$60,000	
Artist Designs & Implementation (applicable WSST included)		
Moving Cost	\$10,000	
PCSP Division review and Bid Advertisement Costs		
Printing Cost (Bid Documents)	\$20,000	
Special Inspection & Testing Fee	\$25,000	
<b>Total 003 - Construction Cost</b>	<b>\$6,358,799</b>	<b>\$6,358,799</b>
<b>004 - EQUIPMENT &amp; FURNISHINGS</b>		
<b>Total 004 - Equipment &amp; Furnish. Cost</b>	<b>\$328,142</b>	<b>\$328,142</b>
Miscellaneous	0	
<b>005 - CONTINGENCY</b>		
Project Conting. ( 15.00% ) of 001, 003, 004, 007, & 009		
<b>Total 005 - Contingency Cost</b>	<b>\$1,121,916</b>	<b>\$1,121,916</b>
<b>007 - COUNTY FORCE DESIGN</b>		
Project Design ( of 001, 003, 004 )		
Other		
<b>Total 007 - CONTRACTED CONST. MGMT.</b>		
Includes cost estimating	\$300,000	\$300,000
<b>009 - COUNTY FORCE ADMINISTRATION</b>		
GGCIP Project Mgmt Hours 150		
<b>Total 009 - County Force Admin. Cost</b>	<b>\$7,500</b>	<b>\$7,500</b>
<b>006 - ART (1% of 001,003,005,007 &amp; 009)</b>	<b>\$82,732</b>	<b>\$82,732</b>
<b>010 - ADMINISTRATIVE OH ( 2.00% of total project cost)</b>	<b>\$173,682</b>	<b>\$173,682</b>
<b>TOTAL PROJECT COST</b>	<b>\$8,857,771</b>	<b>\$8,857,771</b>
Less Existing Funds:		
<b>2008 PROJECT REQUEST</b>		<b>\$8,857,771</b>
<b>SOURCE OF FUNDING</b>		
<b>TOTAL</b>		

King County Courthouse South Entrance Renovation Report

**Attachment E: King County Department of Executive Services –  
Facilities Management Division**

**Courthouse South Entry Renovation Project**

- **Security Layout Graphics for South Entry**
- **Specifications Information for New South Entry  
Security Screening Equipment**

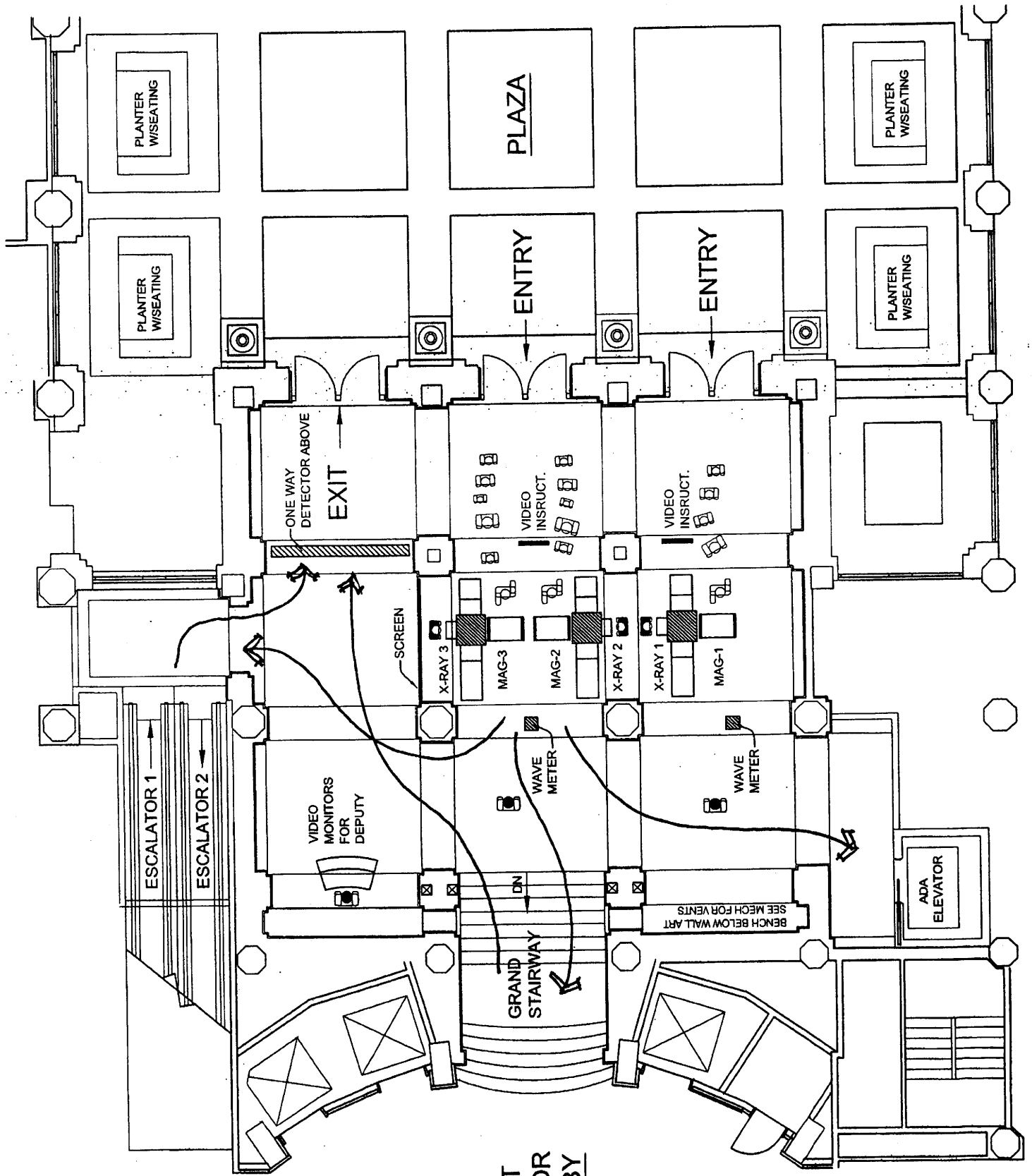

FIRST FLOOR LOBBY

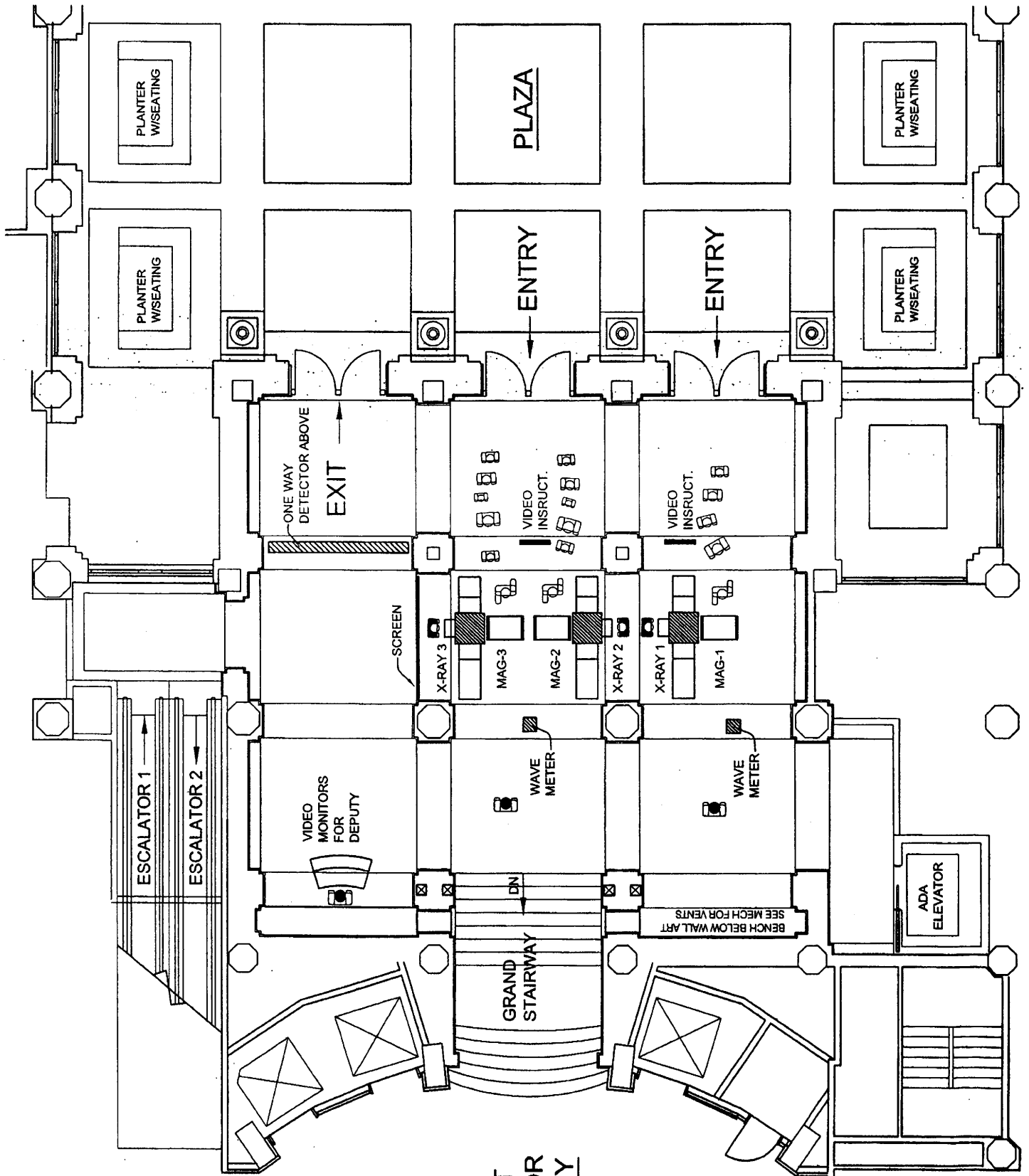

**FIRST FLOOR LOBBY**

## ExitSentry® for Aviation

### Automated Monitoring for Airport Terminal Exit Lanes

ExitSentry® by Cernium is the industry-leading monitoring system that automatically watches people and object flow through airport exit lanes. This TSA-accepted, patented<sup>1</sup> solution has logged over one million hours of proven performance in more than 40 airports throughout North America. ExitSentry's powerful video analytics technology immediately identifies any individual attempting to enter an airport exit lane from the wrong direction. Using both audible and visual alarms, it alerts security personnel and then digitally records the incident for instant playback. ExitSentry maximizes exit lane security and enables security personnel to more efficiently and effectively handle other essential responsibilities during peak traffic times, generating a positive return on investment in a short time.

BENEFITS	KEY FEATURES
Maximum Performance for Your Investment	<ul style="list-style-type: none"> <li>• Patented, field-configurable software that detects wrong-way motion of people and objects; includes anti-passback protection</li> <li>• Compliant with rigorous TSA performance standards</li> </ul>
More Productive, Preemptive Security Forces	<ul style="list-style-type: none"> <li>• Early warning detection and event instant replay</li> <li>• Digital recording and storage of alarm video with time and date stamp</li> </ul>
Simple and Intuitive Operation	<ul style="list-style-type: none"> <li>• User training in under 15 minutes</li> <li>• User-defined pre-alarm warning zone</li> <li>• Multi-media event logging and documentation</li> </ul>
Easy Installation, Integration and Expansion	<ul style="list-style-type: none"> <li>• Interface to other systems and functions for remote alarm notification, intrusion containment, authorized remote bypass, or other functions</li> <li>• Reliable equipment utilizes off-the-shelf components</li> <li>• Accommodates variable lane widths and multi-lane configurations</li> </ul>

<sup>1</sup> U.S. patent number 6,940,998

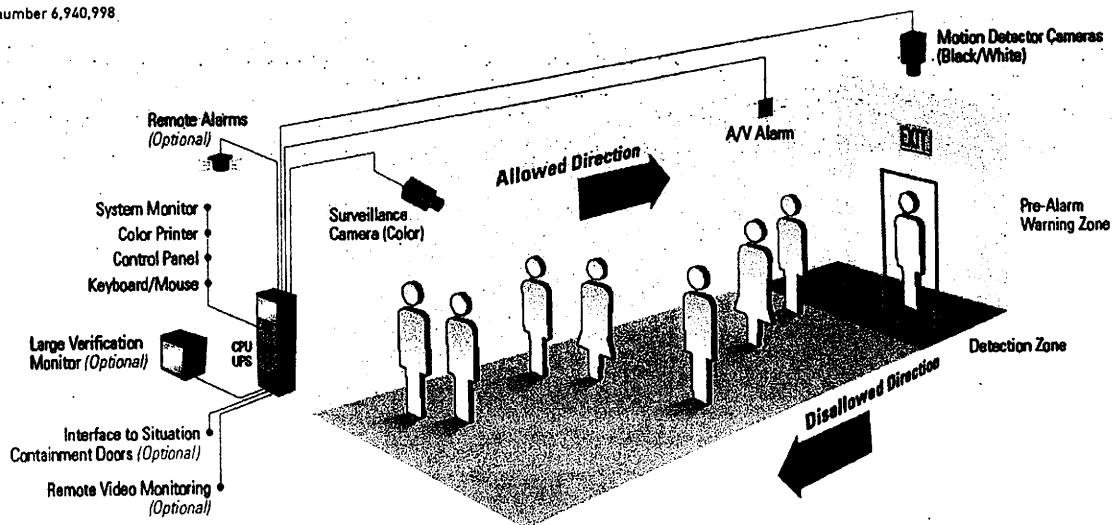
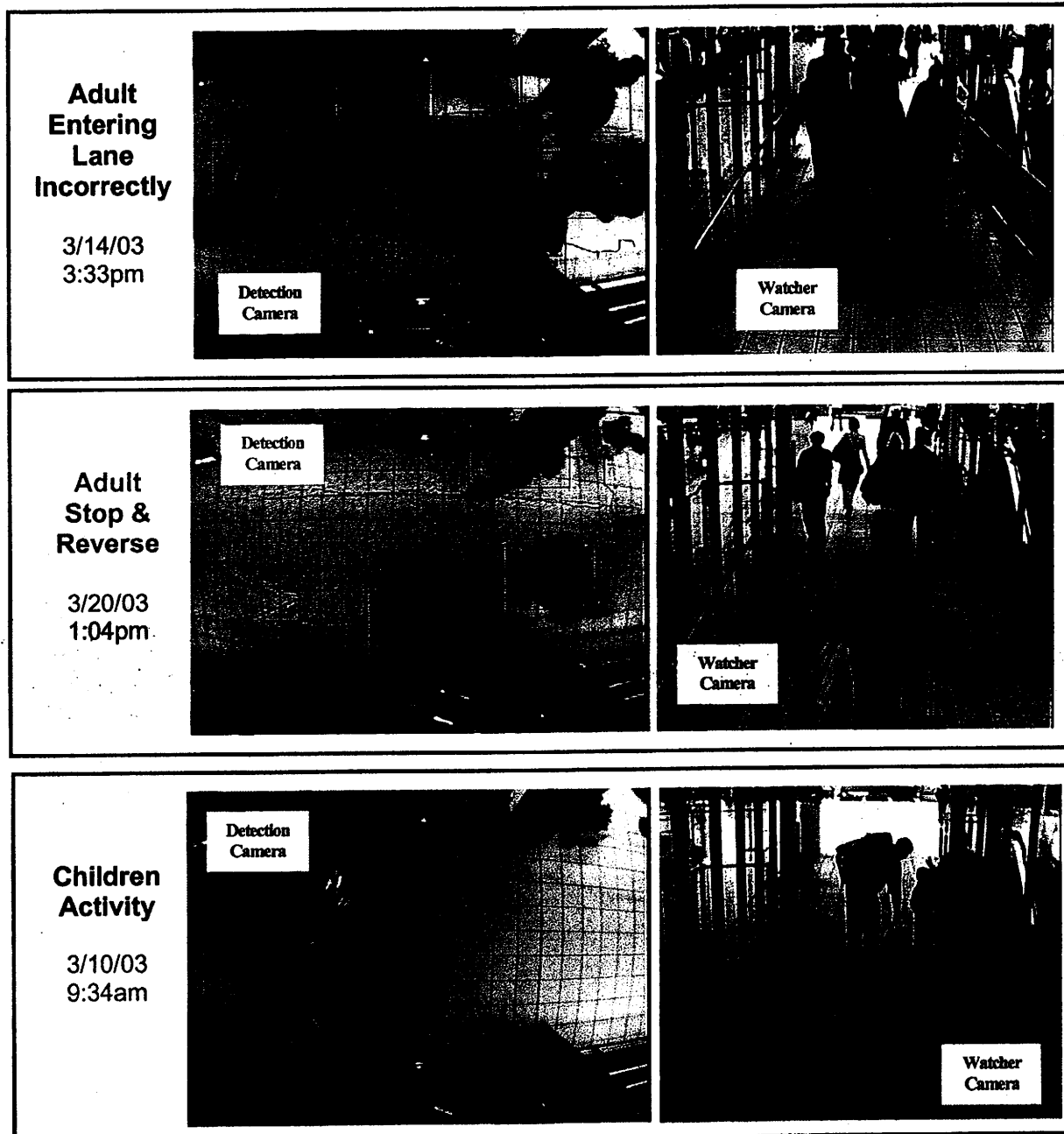

**Figure 1: ExitSentry Airport Exit Lane Monitoring Solution**  
Applies powerful video analytics technology to immediately catch any individual attempting to enter an exit lane from the wrong direction

## EXITSENTRY

### Photographs of Wrong-Way Motion Events

The following photographs were captured by Cernium's ExitSentry System installed in the exit lane of a major U.S. Airport. Each set of two photos, one from the "detection" camera (left side) and one from the "watcher" camera (right side), shows a wrong-way motion event in the exit lane. The "detection" camera tracks each object with a "box" and displays a "tail" representing recent frame history. The "tail" and "box" are **green** if the object is proceeding correctly and **red** once wrong-way motion has been detected.





# Rapiscan 618

# Rapiscan<sup>®</sup> systems

An OSI Systems Company

## BAGGAGE AND PARCEL INSPECTION

- Compact
- Secure Storage
- Dual Energy
- Cost Effective

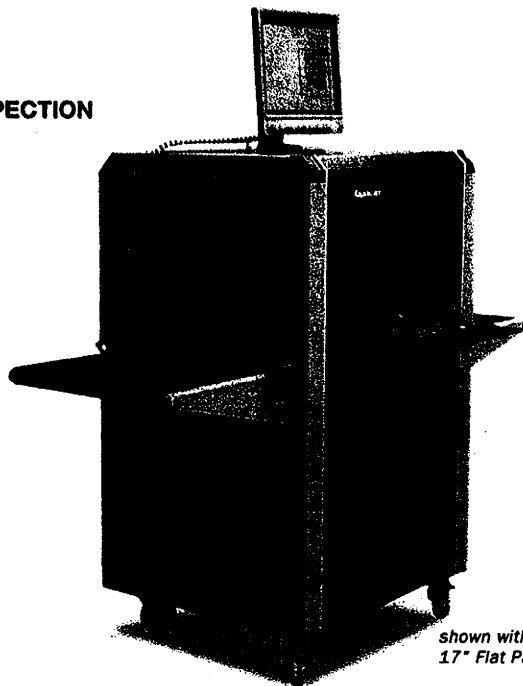

shown with optional  
17" Flat Panel Monitor

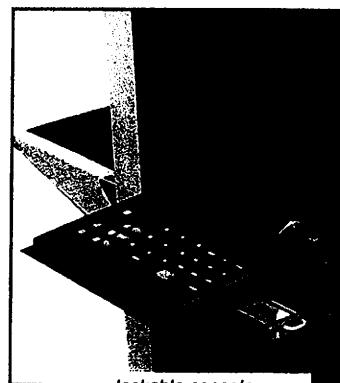

lockable console

The **Rapiscan 618** provides the benefits of a compact and cost effective X-ray system while still providing dual energy performance and a generous tunnel opening of 550mm (21.35 inches) wide by 360mm (14.04 inches) high.

Its innovative design includes a lockable console and folding conveyors for secure and compact storage when not in use. The **Rapiscan 618** has been designed for rapid relocation and can be wheeled through narrow doorways. The **Rapiscan 618** can be part of an effective event based security solution for hotels and convention centers.

## CUSTOMER SUPPORT SERVICES

Our team is dedicated to providing a prompt, effective and personalized response that exceeds your expectations. With spare parts inventory and skilled technicians all over the world, you can be certain Rapiscan Systems will always be prepared with a solution to address your requirements. By measuring response time, parts delivery and support status, our team embraces a customer centric philosophy to ensure continual improvement of our products and services.

## FEATURES & OPTIONS

**Threat Image Projection (TIP):** TIP inserts digital threat images at configurable frequencies into the regular flow of bags. TIP is a reliable method for continually improving the skill level of screeners and is the preferred training method used by regulatory agencies worldwide.

**Network Display Station (NDS):** NDS improves threat detection, throughput, and simplifies operating procedures by enabling the operator performing a manual search of suspect bags to reconcile the actual bag contents with the scanned image.

**Network Management System (NMS):** Allows a supervisor to monitor the performance of many X-ray checkpoints in a large facility from a single location.

**Enhanced Performance X-ray (EPX):** Enables consistent detection of materials having characteristics of explosives, narcotics, gold, currency and agricultural products.

**Operator Training Program (OTP):** OTP enables the X-ray system to be used as a training terminal without running parcels.

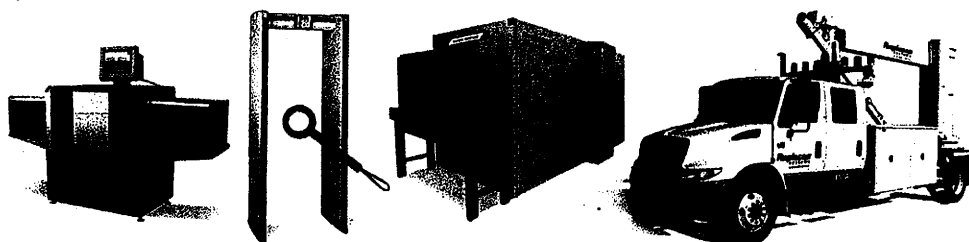

ONE COMPANY - TOTAL SECURITY

## BAGGAGE AND PARCEL INSPECTION

### PHYSICAL SPECIFICATIONS

**Dimensions:** Length: 1,585 mm (61.82 in.) *Unit not in use*  
 Height: 1,360 mm (53.04 in.) *excluding monitor\**  
 Width: 735 mm (28.67 in.)

**Tunnel Size:** 550 mm (W) x 360 mm (H) (21.35 x 14.04 in.)

**Conveyor Speed:** 0.22 m/sec (44 ft./min)

**Maximum Load:** 165 Kg (365 lbs) evenly distributed

**Approx Weight:** Net: 412 Kg (908.3 lbs)  
 Gross: 500 Kg (1,102.3 lbs)

**System Power:** 115 VAC +/- 10% / 60Hz / 10 Amps or  
 230 VAC +/- 10% / 50Hz / 5 Amps

### X-RAY GENERATOR AND IMAGE PERFORMANCE

**Wire Resolution:** 38 AWG guaranteed, 40 AWG typical

**Steel Penetration:** 27mm guaranteed, 29 mm typical

**Material Separation:** Low Z, Medium Z, High Z, to 0.5 accuracy

**Cooling:** Sealed oil bath with forced air

**Anode Voltage:** 160KV rated, operating at 140KV

**Tube Current:** 0.7 mA typical

**Orientation:** Vertically Upward

### HIGH PENETRATION OPTION (HP)

**Steel Penetration:** 35mm guaranteed

**Wire Resolution:** 38 AWG guaranteed, 40 AWG typical

**Anode Voltage:** 180 rated, operating at 160KV

**Tube Current:** 1mA

### COMPUTER SPECIFICATIONS

**Processor Speed:** Intel Pentium® Processor currently available

**Monitor:** 17" XGA color, high refresh, non-flicker

**Memory:** 64 MB RAM minimum

**Video Memory:** 16 MB minimum

**Hard Disk Drive:** 40 GB minimum

**CD-ROM Drive:** 54X

**Floppy Disk:** 1.44 MB

Access to keyboard port and parallel port is provided by means of a lockable access panel on the outside of the machine.

### OPERATING ENVIRONMENT

**Storage Temperature:** -20°C to 50°C

**Operating Temperature:** 0°C to 40°C

**Relative Humidity:** 5 to 95% non-condensing

### HEALTH & SAFETY

All Rapiscan Systems products comply with applicable international health and safety regulations including USA FDA X-ray systems (Federal Standard 21CFR 1020.40) and Health and Safety at Work Act 1974-section 8, Amended by the Consumer Protection Act 1987. Maximum leakage radiation less than 0.1mR/hr (1µ Sv/hr) in contact with outer panels.

**Film Safety:** For ISO 1600/33 DIN, guaranteed up to 10 times exposure to radiation.

**CE Compliance:** Yes

**FCC & IEC Compliance:** Yes

### ISO 9001:2000 Certified

With continual development of our products Rapiscan Systems reserves the right to amend specifications without notice.

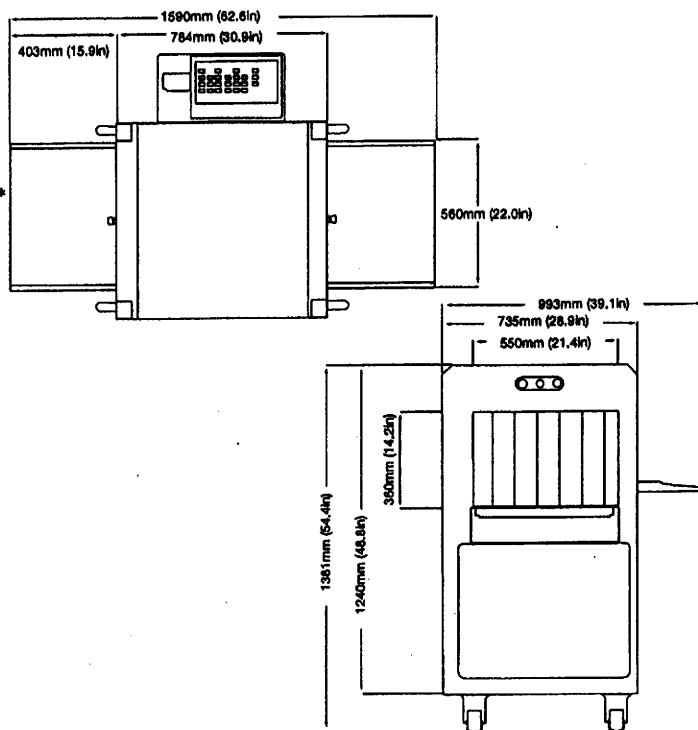

STANDARD FEATURES	OPTIONS
Crystal Clear™	Flat Panel LCD Monitor
Multi Energy Imaging (4 color)	Threat Image Projection (TIP)
Density Threat Alert	TIP Network
Variable Edge Enhancement	Target™-Screener Assist Technology
High/Low Penetration	Network Display Station (NDS)
Variable Gamma	Network Management System (NMS)
Inverse Video	Power Conditioner
Pseudo Color	Secure Workstation
Variable Density Zoom	Remote Workstation
Organic/Inorganic Stripping	Conveyor Accessories
Black and White Viewing	Foot-mat
Variable Color Stripping	UPS (Uninterrupted Power Supply)
Zoom	VCR Output
View Previous Bag	Video Printer
Manual Image Archiving	Automatic Image Archiving
Baggage Counter	Auto Reject Unit
Search Indicator	High Penetration X-ray Generator
Date/Time Display	Foldable Conveyor
Full Diagnostic Built In Test Facility	Protective Tunnels
Operator Training Program (OTP)	
Enhance Performance X-ray (EPX)	

9150100-1

[www.rapiscansystems.com](http://www.rapiscansystems.com)

### UNITED STATES OF AMERICA

3232 W. El Segundo Blvd.  
 Hawthorne, California 90250

UNITED STATES OF AMERICA

Tel: +1 310-978-1457

Fax: +1 310-349-2491

### E-MAIL

[sales@rapiscansystems.com](mailto:sales@rapiscansystems.com)

### UNITED KINGDOM

X-Ray House  
 Bonehurst Road

Salfords

Surrey RH1 5GG

UNITED KINGDOM

Tel: +44 (0) 870-7774301

Fax: +44 (0) 870-7774302

### ASIA PACIFIC

240 Macpherson Road  
 #06-04 Pines Industrial Building  
 Singapore 348574

SINGAPORE

Tel: +65-6743-9892

Fax: +65-6743-9885 / 6743-9915

distributor stamp

082114

# Meteor 300

Walk-Through Metal Detector

# Rapiscan® systems

An OSI Systems Company

## PEOPLE SCREENING

Enhanced Multi-Zone Principle

Excellent Detection and Immunity

Innovative User-Interface

Appealing Design

The Meteor 300 is a second generation true multi-zone metal detector. It offers superior performance for demanding high security applications.

### SUPERIOR DETECTION AND DISCRIMINATION

Utilizing an intelligent 8Z8F architecture, the Meteor 300 offers top-class performance in metal detection and unbeatable detection uniformity for metal threat objects regardless of their shape and orientation. This is achieved with an overlapping new multi-zone coil system, which combines the unique true multi-zone features with frequency distribution technology. The operating frequency distribution eliminates electromagnetic interference present at installation environments today. Together with effective digital signal processing it offers excellent interference immunity.

The Meteor 300 can detect multiple threat objects independently in different zones. Due to eight independent detection zones, signals from distributed harmless objects do not combine to produce unnecessary alarms. In addition, independent detection zones enable free sensitivity adjustment of each zone.

### MAXIMIZE THROUGHPUT

The Meteor 300 is equipped with two integrated zone displays. These identify the level(s) at

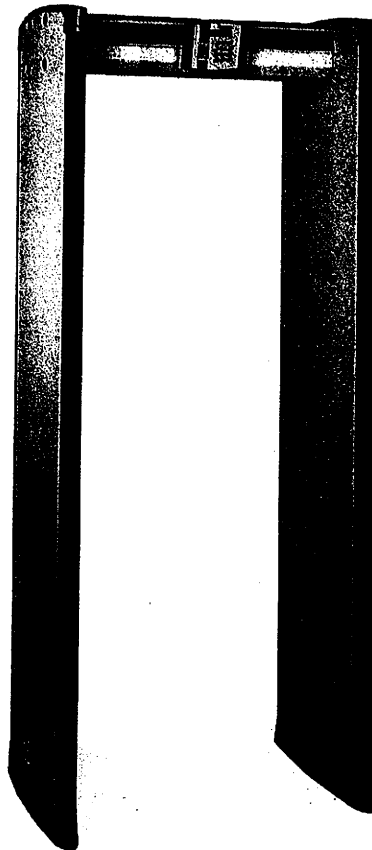
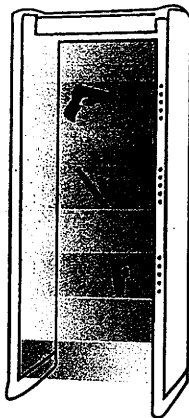

which detected object(s) are carried. The zone displays enable security personnel to immediately target metal objects and ensure that maximum throughput can be maintained. In addition, the Meteor 300 is equipped with traffic lights (green and red) indicating when the passenger can pass through the gate.

### EASY TO INSTALL, SIMPLE TO OPERATE

The Meteor 300 display unit can be mounted on all four sides of the detector. This improves flexibility in installation and when operating the unit. The display unit has a 2x20 character alphanumeric display. It gives information on how to operate the unit, and also functions as a signal level indicator. In addition, the display unit has LED bars showing the zone display indication. This increases the visibility of the zone display information.

All parameters are set through a bi-directional remote control unit that enables the copying of the parameters from one unit to other units. This control unit, unique only to Meteor

brand products, makes programming several detectors fast and easy. The menu structure of Meteor 300 resembles mobile phones' user interface and is therefore familiar to many users. Help texts in the menu further facilitate the operations. The user interface has three user levels: OPERATOR, USER and SUPERUSER. The Meteor 300 has a memory bank, which enables storing customer specific parameter settings.

### VERSATILE DETECTION PROGRAMS

The Meteor 300 walk-through metal detector includes preset weapon specific detection programs to meet the requirements set by internationally recognized authorities. When developing new detection programs we use electromagnetic responses from real guns and knives, and thereby the programs reflect real-life threats.

The Meteor 300 also incorporates an advanced Random Alarm function, which enables discreet search of non-alarming passengers.

### ENHANCED SECURITY

To guarantee tamperproof and continuous operation, the switches, cables and connectors in the Meteor 300 are built-in, and the remote control unit can be locked inside the crosspiece. The remote control unit operation is secured with passwords and a code hopping encryption algorithm to prevent unauthorized access. The ON/OFF switches can be accessed with or without a key.

### STATISTICS

Intelligent traffic and alarms counters calculate the traffic flow and resultant alarms. The counters both increment and decrement, thereby giving a true traffic count.

## OPTIONS & ACCESSORIES

**BATTERY BACKUP SYSTEM:** For 2-hour runtime when no power is available.

**METORNET 3 PRO:** Remote Security Management System collects the statistics on traffic flows and alarm data of up to 255 Meteor walk-through metal detectors and generates easy-to-read reports. It allows detector security levels to be changed from a central PC.

**TEST PIECES:** To assist in calibration and testing.

**ADA COMPLIANT CROSSPIECE:** 32 in. crosspieces are available to meet ADA compliance for wheelchair accessibility.

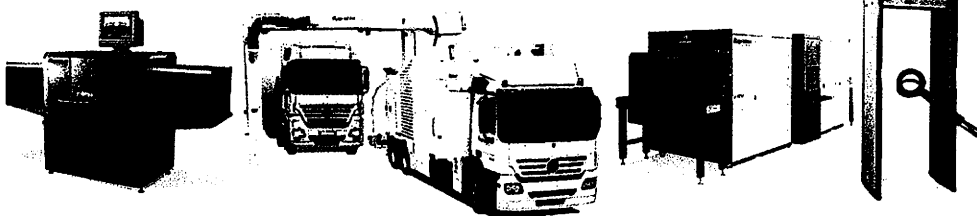

ONE COMPANY - TOTAL SECURITY

## PEOPLE SCREENING

**USA, CANADA, LATIN AMERICA**  
8 Commerce Way  
Suite 115  
Robbinsville, New Jersey 08691  
UNITED STATES of AMERICA  
Tel: +1 609-406-9000  
Fax: +1 609-530-0842  
Toll Free: 1-800-963-8676

**AMERICAS**  
2805 Columbia Street  
Torrance, California 90503  
UNITED STATES of AMERICA  
Tel: +1 310-978-1457  
Fax: +1 310-349-2491

**EUROPE, AFRICA, MID EAST**  
Nihtisilankuja 5, P.O. Box 174  
FIN-02631 Espoo  
FINLAND  
Tel: +358 9 32941500  
Fax: +358 9 32941302

X-Ray House  
Bonehurst Road  
Salfords  
Surrey RH1 5GG  
UNITED KINGDOM  
Tel: +44 (0) 870-7774301  
Fax: +44 (0) 870-7774302

**ASIA**  
240 Macpherson Road  
#06-04 Pines Industrial Building  
Singapore 348574  
SINGAPORE  
Tel: +65-6743-9892  
Fax: +65-6743-9885

**AUSTRALIA**  
Rapiscan House  
4 Ross Street  
South Melbourne Victoria  
Australia 3205  
AUSTRALIA  
Tel: +61 3 9929 4601  
Fax: +61 3 9929 4655

**E-MAIL**  
sales@rapiscansystems.com

ISO 9001:2000 Certified

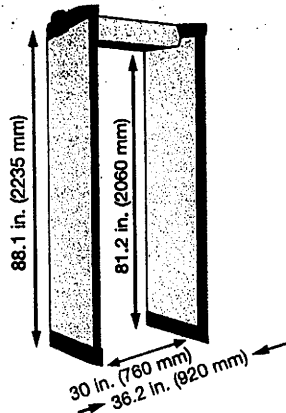

CONFORMITY	
Safety Standards	The Meteor 300 meets with the limits set by international standards for human safety. Safe for wearers of heart pacemakers, pregnant women and magnetic recording materials.
CE Compliant	Yes, conforms to the applicable international standards for electrical safety and EMC.
Other Standards	UK DfT Approved
SPECIFICATIONS	
Ambient Operating Temperature	From -10 °C to +55 °C (From +14 °F to +131 °F)
Humidity	0 to 95%, no condensation
Protection	IP 41 (EN 60529)
Power Supply	AC Power: 90-264VAC/47-63Hz Battery: 12V DC Consumption: 72W Fuse: T2A 5x20 mm Power cord length: 2.5 m (8.2 ft) Automatic adjustment, without manual intervention, for power fluctuations over the voltage range of 90 to 264V AC.
Alarm	Audible/visible alarm. 2 x 20 character alphanumeric display and Zone Display. Alarm relay contact.
Alarm Time	Adjustable
Sensitivity	100 sensitivity steps in each program.
Zone Sensitivity Adjustment	All eight independent zones are individually adjustable (0 to 255 %) with respect to the overall sensitivity level.
Calibration	Automatic or manually set. An automatic sensitivity function selects the appropriate sensitivity for a specific weapon or test object. This eliminates the time consuming trial and error method.
Interference Suppression	Intelligent 8Z8F architecture. Digital filtering. User selectable operating frequencies
Warranty	Two (2) years, parts and labor
Self-Testing Diagnostics	User-friendly diagnostics identify fault condition.
Maintenance	Low maintenance costs due to self-testing diagnostics, easy access and modular electronics.
Network Connections	MeteorNet Remote Security Monitoring System compatible (RS422 and Ethernet)
Shipping Weight & Volume	Total: shipping weight: 94.2 kg (207.7 lbs) shipping volume: 0.51 m3 (18.02 cu ft) Net Weight: 75.8 kg (167.1 lbs) Coils: shipping weight: 73.8 kg (162.7 lbs) shipping volume: .40 m3 (14.13 cu ft) Cross bars + electronics: shipping weight: 20.4 kg (44.9 lbs) shipping volume: 0.11m3 (3.87 cu ft)

The Meteor 300 has received the world's first environmental certificate for walk-through metal detectors.

## APPLICATIONS

Airports	Public Buildings	Courthouses	VIP Protection
----------	------------------	-------------	----------------

[www.rapiscansystems.com](http://www.rapiscansystems.com)

**CUSTOMER SUPPORT SERVICES:** Our team is dedicated to providing a prompt, effective and personalized response that exceeds your expectations. With spare parts inventory and skilled technicians all over the world, you can be certain Rapiscan Systems will always be prepared with a solution to address your requirements. By measuring response time, parts delivery and support status, our team embraces a customer focused philosophy to ensure continual improvement in customer support, products and services.

With continual development of our products Rapiscan Systems reserves the right to amend specifications without notice.

distributor stamp

# MetorNet 3 Pro

Remote Security Management System

# Rapiscan<sup>®</sup>

systems

An OSI Systems Company

## PEOPLE SCREENING

Centralized Security

Management

Remote Monitoring &

Adjustment

**MetorNet 3 Pro** is a Windows based remote security management system. It enables monitoring and adjustment of all parameters of the Metor family of walk-through metal detectors from a single PC.

### COLLECTS STATISTICS

**MetorNet 3 Pro** collects statistics from the Metor walk-through metal detectors with passenger and alarm counters. These statistics can be summarized and printed in easy-to-read reports. In addition, collected statistical information can be stored in ACCESS format into a database for further processing. The user can select whether the database is stored on a PC or on a network drive.

### SAVING THROUGH RESOURCE ALLOCATION

By collecting statistics through **MetorNet 3 Pro**, it is easy to allocate personnel to the right places at the right time.

### CONTROL NETWORK FEATURE

The operator receives a written message whenever there is a deviation from the original settings stored in the PC. This quickly indicates any misuse or malfunction of the gate and increases the overall security level.

### EASY CONNECTIVITY

Because **MetorNet 3 Pro** utilizes existing Ethernet cabling at the customer's premises, adding new Rapiscan Systems Metor metal detectors to the **MetorNet 3 Pro** network is very easy. The need for expensive cabling is minimized thus reducing costs.

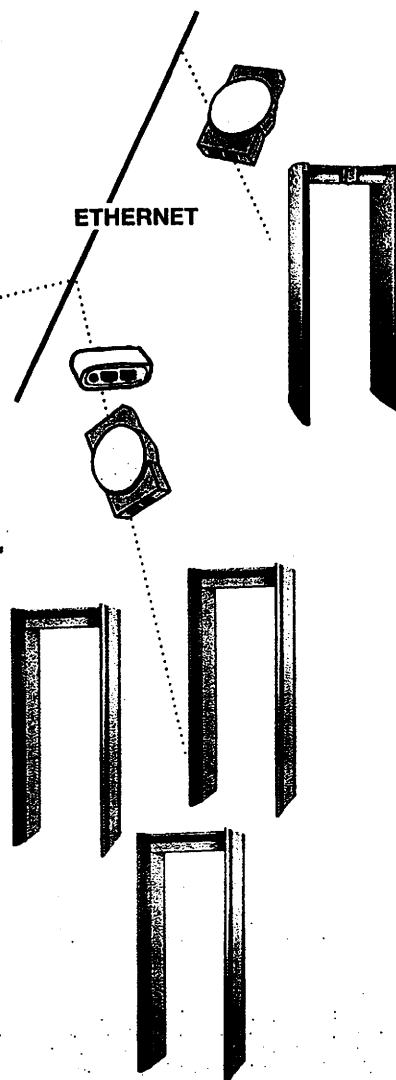
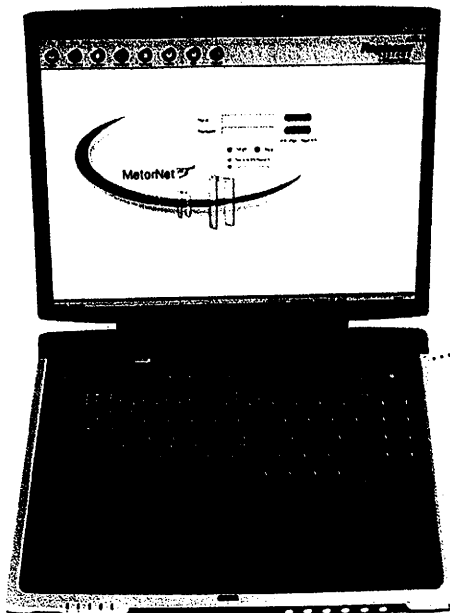

### ENHANCED USER INTERFACE

- All parameters of the topology can be controlled
- An image of each metal detector is shown
- Pop-up menus
- Built-in help system
- Colors can be configured on the topology

### OVERALL SYSTEM MANAGEMENT

Up to 255 metal detectors can be connected to one network. The gates can be grouped and identified individually and/or by group name. The user can define the security level (set of parameters), which can be applied to an individual gate, to a group of gates, or to a whole network.

### SUPERIOR SYSTEM SECURITY

**MetorNet 3 Pro** has two user levels: USER and SUPERUSER. The SUPERUSER has access to all parameters and can assign editable USER access rights. Each USER/SUPERUSER can have an individual password to prevent unauthorized access. The amount of USER/SUPERUSER accounts is unlimited. **MetorNet 3 Pro** also provides Log in and Log out data.

## APPLICATIONS

**MetorNet 3 Pro** offers an easy way to manage one or several gates through a single PC in the following applications;

Airports

Prisons

Industry

Amusement Parks

Financial Institutions

Special Events

Distribution Centers

Government Buildings

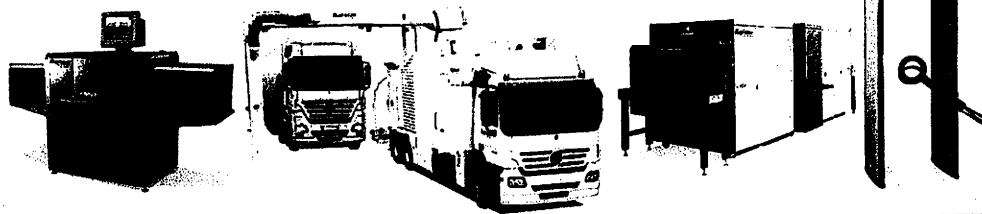

ONE COMPANY - TOTAL SECURITY

### PEOPLE SCREENING

**USA, CANADA, LATIN AMERICA**  
8 Commerce Way  
Suite 115  
Robbinsville, New Jersey 08891  
UNITED STATES of AMERICA  
Tel: +1 609-408-9000  
Fax: +1 609-530-0842  
Toll Free: 1-800-963-8676

**AMERICAS**  
2805 Columbia Street  
Torrance, California 90503  
UNITED STATES of AMERICA  
Tel: +1 310-978-1457  
Fax: +1 310-349-2491

**EUROPE, AFRICA, MID EAST**  
Nihtilailankuja 5, P.O. Box 174  
FIN-02631 Espoo  
FINLAND  
Tel: +358 9 32941500  
Fax: +358 9 32941302

X-Ray House  
Bonehurst Road  
Salfords  
Surrey RH1 5GG  
UNITED KINGDOM  
Tel: +44 (0) 870-7774301  
Fax: +44 (0) 870-7774302

**ASIA**  
240 Macpherson Road  
#06-04 Pines Industrial Building  
Singapore 348574  
SINGAPORE  
Tel: +65-6743-9892  
Fax: +65-6743-9885

**AUSTRALIA**  
Rapiscan House  
4 Ross Street  
South Melbourne Victoria  
Australia 3205  
AUSTRALIA  
Tel: +61 3 9929 4601  
Fax: +61 3 9929 4655

**E-MAIL**  
sales@rapiscansystems.com

ISO 9001:2000 Certified

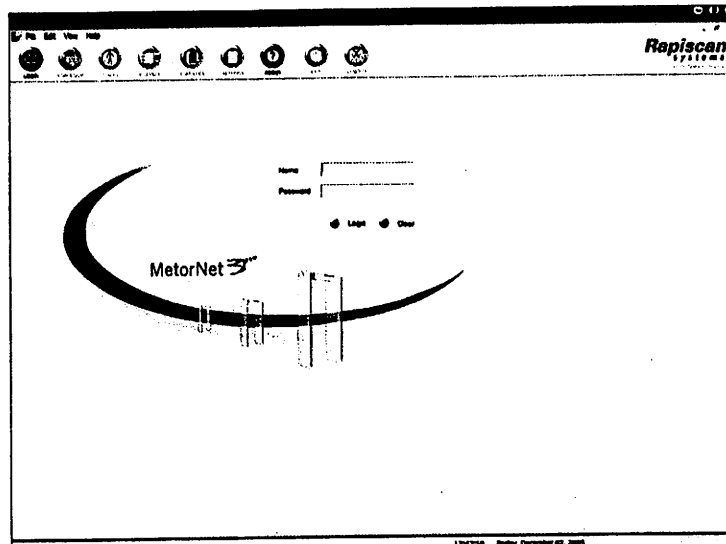

LOGIN SCREEN

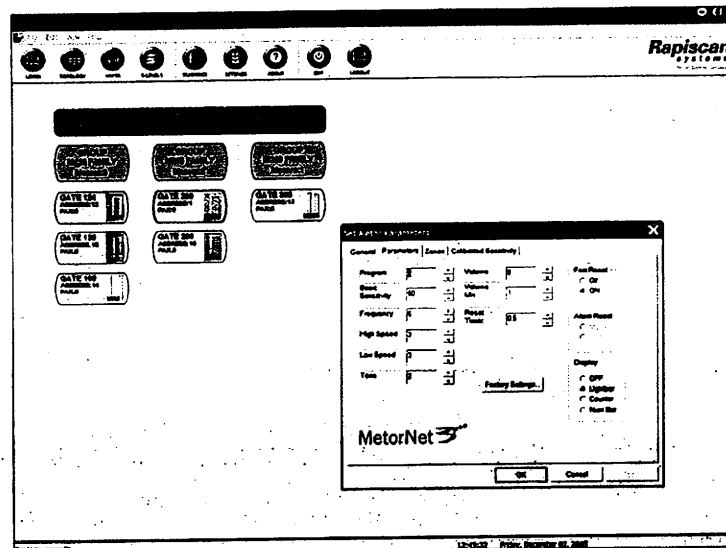

TOPOLOGY

SYSTEM REQUIREMENTS	
Processor CPU	Pentium 4 2GHz or higher
Memory	256 MB Ram
Operating System	Windows 2000 or Windows XP
Hard Drive	1-2 GB mininum

[www.rapiscansystems.com](http://www.rapiscansystems.com)

**CUSTOMER SUPPORT SERVICES:** Our team is dedicated to providing a prompt, effective and personalized response that exceeds your expectations. With spare parts inventory and skilled technicians all over the world, you can be certain Rapiscan Systems will always be prepared with a solution to address your requirements. By measuring response time, parts delivery and support status, our team embraces a customer focused philosophy to ensure continual improvement in customer support, products and services.

*With continual development of our products Rapiscan Systems reserves the right to amend specifications without notice.*

distributor stamp

A person is shown in a dark, grainy environment. A small, rectangular inset image is overlaid on the person's torso, showing a patterned object, possibly a bag or container, which is the focus of the advertisement's theme.

Can you see what they're hiding?

A large, white, rectangular scanning unit is shown on the left side of the advertisement. It has a small square sensor or display on the front and a Brijot logo near the bottom. The unit is positioned vertically.

**The BIS-WDS<sup>®</sup> GEN 2 Can!**  
Millimeter Wave Object Detection and People Screening System

The Brijot logo features a stylized globe icon to the left of the word "Brijot" in a bold, sans-serif font. Below the name is the tagline "Leading the way in security".

**Brijot<sup>®</sup>**  
Leading the way in security

# Is it practical to screen everyone that enters—or exits—your facility, without affecting the efficiency of your operations?

Do you know what your visitors, workforce, passengers, or spectators, are concealing past your metal detectors, bringing onto your transit system, into your stadiums, or are taking out the door with them? Is your security staff forced to guess who is hiding something without stopping and questioning each one? The Brijot BIS-WDS® GEN 2 System will allow you an easier way to know who to search and pinpoint where to look!

Brijot Imaging Systems, Inc. is proud to introduce the BIS-WDS® GEN 2—the next generation cutting edge object detection and people screening technology. System features include full-motion, real-time passive millimeter wave imaging capabilities. Empowering you to detect concealed threats sooner, minimize loss prevention more effectively, and virtually pat down and screen people in areas that you have not been able to search them before.

- Monitored remotely
- In real time
- Without requiring cooperation
- Without a physical pat down

Brijot's standoff passive millimeter wave imaging system offers security and loss prevention officials a quick and discrete method for detecting suspicious hidden items...whether they're explosives, weapons, contraband, stolen electronics, or other items. The GEN 2 also reveals hidden liquids and gels. Brijot's millimeter wave imaging solution is the most effective high-throughput people screening system available today to effectively detect these potential threats.



## What is the BIS-WDS® GEN 2?

Brijot's GEN 2 technology is composed of a real-time Radiometric Scanner that images electromagnetic millimeter wave energy, an integrated full-motion video camera, on-board computer, and sophisticated, intelligent video detection engine. Using the GEN 2 value-added detection engine's capability your security screeners will automatically be alerted and can easily pinpoint concealed objects without intrusive, time-consuming, personnel-intensive and potentially dangerous physical searches, while allowing security screeners and law enforcement officers to perform "virtual" pat downs from a distance without direct contact. Brijot provides an effective means to manage threats before they become harmful incidents.

## How does it work?

The system's *passive* Radiometric Scanner can detect concealed objects by distinguishing between the millimeter wave energy naturally emitted by the human body and the energy of the concealed objects even when they're hidden beneath clothing. It accomplishes this without radiating subjects, or posing health risks even to those persons with pacemakers, or pregnant women. Deployed as a stand-off application it will not cause claustrophobia and is a safe and discrete screening solution for all. Further, Brijot's millimeter wave sensors do not image anatomical details, thus protecting passenger privacy.

## Feature Highlights:

- Detects concealed objects in as little as 0.5 second
- Subjects walk through the screening area when deployed in two-camera configurations
- Anatomical details are not revealed thereby eliminating personal privacy issues
- Completely passive system—no transmission of radiation or energy of any kind
- Seamless integration facilitating remote operation and administration of man-traps
- Monitoring & detection displayed to the operator in real-time
- Provides standoff detection of large explosives, liquids, gels, and other ferrous and non-ferrous items.







## Applications

Used alone or as part of a comprehensive, multi-layered security solution, choose Brijot's proven reliability to achieve your security goals. Deploy the system as part of a high-security entrance portal, integrate it with existing devices such as X-Ray or metal detectors and find the items they are missing. Or use the GEN 2 to monitor your exits—you can even remotely image unattended locations. The GEN 2 is a must for any place where protection of life or loss prevention demands knowing **which people are concealing hidden items—and pinpoint where they're hiding them.**

**Standoff Bomb and Weapon Detection: Protection from the threat.** There is no need to put security staff or military personnel at arm's length from danger in high risk areas. Operated remotely, the GEN 2 can detect explosives or weapons and trigger a "lock-down" event, holding the suspect within a secure area. In today's high security environment, Brijot's imager adds an extra layer of protection, isolating the threat and alerting security personnel that a potential danger is approaching.

**Airport/High Security Transportation Hubs: See what you're missing!** Some locations—like airports and other critical transportation hubs, have already invested in security screening technologies like X-ray machines, metal detectors, and added security staff. But those technologies can't see explosive materials, liquids and gels, or thick packets of currency. GEN 2 can be integrated into your existing security

strategy, and by imaging subjects in motion, it can be used to direct subjects into secondary screening lanes for further investigation, focusing security efforts and eliminating profiling or ineffective random screening.

**Government Buildings/High-Security Hotels: Broaden counter-terrorism measures!** Terrorism is one the greatest threats to the safety and security of public and private buildings such as federal office buildings, hotels and many national icons. The best defense to safeguard your facility, organization and operations is "detection" that enables an immediate "assessment" for the proper "reaction." With Brijot's GEN 2 millimeter wave technology you have full-motion, real time imaging capabilities which allow you to safeguard property and lives effectively. GEN 2 can be positioned at a distance from security personnel and operated remotely to protect them from the threat posed by suicide bombers.

**Loss Prevention: Stem the tide of product shrinkage!** Loss prevention personnel will find the GEN 2 invaluable in identifying hidden objects exiting a facility. The system can image metals, wood, electronic devices, bottles of liquor... even fresh or frozen food! Managers and security personnel can pat down employees virtually without physical contact. Event logging functionality records the detection, providing ideal documentation in the event of an employee termination or theft prosecution.

## Graphical User Interface

**How easy is it to use?** Brijot's Graphical User Interface (GUI) is a simple, easy to understand tool for all operators—you can identify hidden objects without confusion or delay. With minimal training, a GEN 2 user can clearly identify and locate hidden objects in real-time by observing event icons and detection boxes on a full-motion video images. Each event's video and passive millimeter wave images are digitally archived for later review, analysis, or evidentiary use. The JPEG images stored are millimeter wave images with no anatomical detail, ensuring personnel privacy is maintained.

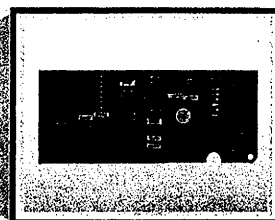
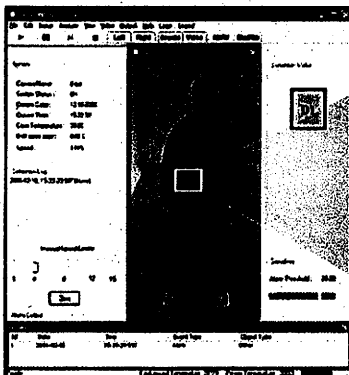

Loss Prevention Application  
Detection: Circuit Board

## Real-time Detection Engine

**What's that they're hiding?** Know sooner with our value-added detection engine, which identifies threats and concealed items on a subject in real-time—in as little as 0.5 second. The GEN 2 automatically alerts operators to the presence of very large objects—such as bombs—that could pose a serious threat. Indicator boxes pinpoint the precise area of hidden objects on the full-motion video and millimeter wave images. Displaying multiple detection events simultaneously, detection events can also serve as the "probable cause" that triggers secondary inspection events to examine an individual more closely.

## Integration

**What about my current systems?** Good security often requires a multi-layered approach, incorporating a range of tools and carefully planned protocols, and the GEN 2 is designed to integrate seamlessly with other security systems. Each system has multiple inputs and outputs, and data can be accessed using the system's Application Programming Interface (API), allowing the Brijot system to work in tandem with your existing or planned security technologies. Brijot's system can be configured to trigger a "man-trap" application, locking out, or locking in individuals until you can identify what they're hiding.

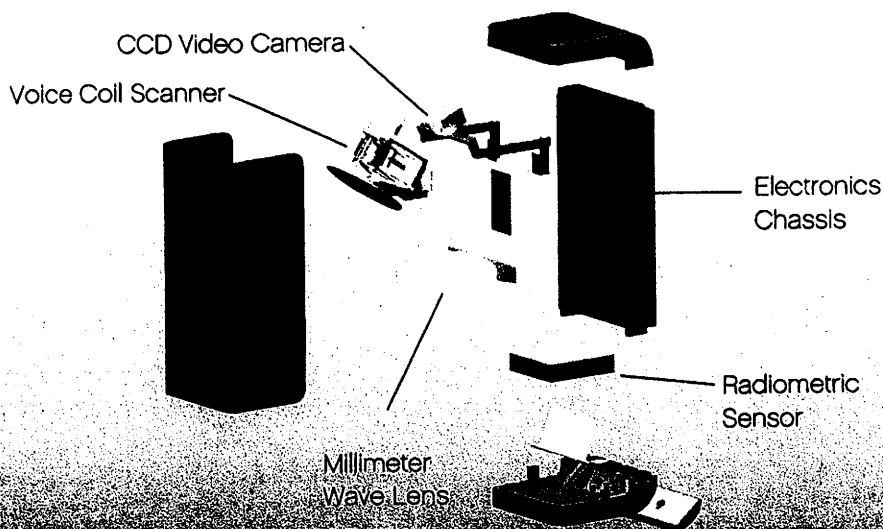

2007-0618

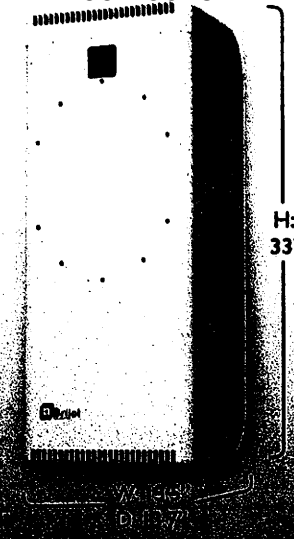

### Functional Considerations

**Standard deployment:** Indoor and outdoor environments. Some indoor settings and all outdoor deployment may require environment altering as specified by certified implementation personnel.

**Indoor deployment considerations:** Ambient air temperature not to regularly exceed 26° C (80° F). Anomalous heat sources behind walls and beneath floors. Sources of energy including sky access and reflective interior surfaces.

**Other deployment considerations:** Traditional CCTV deployment considerations apply. Minimize saturation – Avoid facing system directly into sunlight (CCTV camera consideration) or at the sky (millimeter wave system component consideration). Though the radiometer can operate in low- or no-light settings, the integral CCTV component requires lighting the FOV for effective video imaging.

### Features

**Imaging capabilities:** Metals, plastics, ceramics, composites, glass, liquids, gels, explosives, weapons, currency, tobacco goods, and wood—including those commonly used to construct weapons and explosive devices.

**Minimum object size:** Imaged pixel size: Approximately 5 cm x 5 cm (2 in x 2 in). Detection engine optimization: Approximately 7.6 cm x 12 cm (3.0 in x 5.0 in)

**Large object detection:** Program system's detection engine to treat identification of large objects differently. Use system's alarm utility to configure and trigger specific actions upon detection.

**Simultaneous processing:** Detection engine processes multiple simultaneous detections. GUI displays up to 3 detection or "Large Object" icons at a time and features a contiguous running event log.

**Fully-integrated on-board computer:** Pentium®-based processor enables stand-alone operation without external PC connection. Microsoft Windows XP™ Operating System integrates with local area networks for remote viewing and control via GEN 2 Application Software and APIs.

**Anti-tamper software:** Applications actively prevent, detect and react to tampering and reverse engineering.

**Imaging speed:** MMW radiometer 4 to 12 frames per second (FPS); CCTV 30 FPS

**Detection engine indications:** Tri-colored box over location of detection on subject video image. Detection box features a black outside line, a white middle line and one of the following colors as the inside line, determined by the user-defined detection settings:

• Blue: D2 level detection (warning) • Yellow: D1 level detection (alarm) • Red: L large object detection

A corresponding tri-colored box also appears on the "Detection Status" area of the GUI with "D1," "D2" or "L" detection status icons.

### Specifications

**Power supply:** External Supply, 100 to 240 VAC, 47-63 Hz, 120 W; output 12 VDC, 10 A

**Detector millimeter wave frequency:** 80 to 100 GHz (90 GHz center frequency, 20 GHz bandwidth)

**Operating temperature:** -10°C to 50°C (14°F to 122°F)

**Operating humidity:** 0 to 100% RH condensing (outdoor use)

**Dimensions (H x W x D):** 83.8 cm x 34.5 cm x 34.9 cm (33.0 in x 13.5 in x 13.7 in) excluding mounting bracket

**Weight:** Net: approx. 39 kg (86 lbs) - excluding mounting bracket

### Interfaces

**Analog video output:** NTSC or PAL, BNC connector

**Monitor output:** D-sub 15 (VGA) connector (1024 x 768 72 Hz default)

**Control, setup and monitoring:** 10/100 Ethernet, RJ45

**Peripheral Interface:** Two USB 2.0; two IEEE 1394a (FireWire)

**Keyboard/Mouse:** Combined PS/2-type mini-DIN connector

**Discrete I/O:** 10 Position Phoenix™ connector; three user-defined outputs (dry contact Form C relay) and two user-defined inputs (opto-isolated)

**Audio:** One 3.5 mm jack for LINE OUT; one 3.5 mm jack for MIC IN

### Innovative Detection/ Screening Solutions

Everyday, Brijot's cutting edge object detection/people screening system offers unsurpassed technology meeting security challenges in high threat environments. Brijot combines innovative engineering, quality materials, workmanship, outstanding customer service, and competitive pricing to bring you exceptional value. Brijot is a privately held USA Company, with corporate and training offices in Orlando, Florida. Brijot manufactures its system in an ISO 9000:2000 certified environment—another reason to select Brijot.

#### Brijot Imaging Systems, Inc.

5422 Carrier Drive, Suite 107  
Orlando, FL 32819

Phone: 1-407-641-4370

1-866-SAFERWORLD

Fax: 1-407-351-9455

Email: info@brijot.com

Internet: www.brijot.com



**Imaging a safer world®**

**DORMA**

**Security Revolving Doors**  
**Large Diameter Revolving Doors**



**Crane Revolving Doors**

## Feel secure with Crane

Crane's Security Revolving Door offers the building team a perfect combination of everyday functionality and rigorous access control. Our time-tested designs and manufacturing processes—along with an unwavering dedication to quality—provide doors that meet modern demands for security and aesthetic beauty.

### Control in an unpredictable world

Security needs differ from entrance to entrance, from building to building. Our Security Revolving Doors deliver exceptional control for offices, retail stores, hotels, government facilities and other applications.

Our doors can be configured to provide two-way or one-way (exit only) controlled access. You can customize settings depending on the time of day, for example, offering standard automatic or manual operation during the day and security at night. You can select custom dimensions—anything from 6'-0" I.D. to 10'-0" O.D. with maximum heights from 7'-0" to 9'-6" depending on width. In addition, Crane's patented Bookfold Collapse Lock prevents unauthorized activation of bookfold mechanism while maintaining all code criteria for revolving entrance doors.

### Brains behind the brawn

Crane's Security Revolving Doors can be integrated with a variety of activation devices—such as card readers, keypads, and sensors to enable or deny entry. Floor mats detect unauthorized use, preventing entry and triggering a voice announcement of security violation. Safety is provided by back pressure sensing and edge strip protection at the quarter posts.

Security functions can be programmed to fit your custom needs. A 90 V.D.C. motor power drive unit in the door offers reliable and controlled rotation according to your security needs. A 12" or 18" minimum canopy height is required to house power units and security components.

### Secure and attractive at the same time

Bullet resistant and blast resistant, Crane's Security Revolving Doors benefit from robust engineering and material selection to render a door that works as good as it looks. Heavy-duty metals and painstaking assembly make our doors ideal for big city applications, government buildings and other structures where additional security is desired.

Stainless steel and bronze (satin or mirror finish or custom) finishes are fully welded to a formed, welded heavy gauge stainless steel or steel subframe that allows unparalleled strength in Crane doors. Aluminum finishes (anodized or painted finish) are welded and mechanically finished. Crane's experienced engineers and craftsmen will help you design a door that meets your aesthetic requirements, too. Various options and attachment configurations allow you to create a visually striking entryway that complements your building's design and is secure.

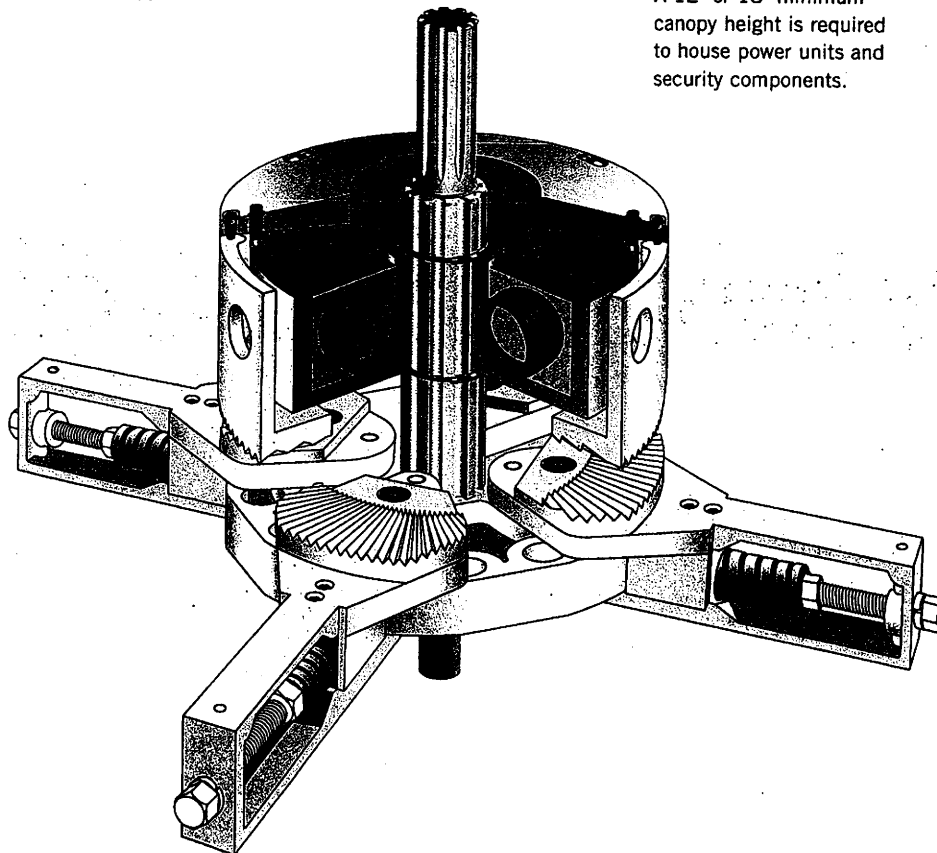

Crane's patented Bookfold Collapse Lock prevents unauthorized activation of bookfold mechanism while maintaining all code criteria for revolving entrance doors.

## Large Diameter Revolving Doors that deliver big benefits

For six decades, architects and building owners have relied on Crane to provide the industry's most reliable and aesthetically pleasing revolving doors. That reputation for quality and excellence has been incorporated into our Large Diameter Revolving Doors.

Available in three- and four-wing configurations, Crane's Large Diameter Revolving Doors are ideal for hospitals, extended-care facilities, grocery stores, high-volume retail stores, hotels and other high-traffic applications where large objects accompany people through entryways and automatic revolving door action is desired.

### A fitting entrance

Large Diameter Revolving Doors from Crane can be sized to an outside diameter up to 12'-0" in custom heights depending on the opening. They require a 12" minimum canopy fascia.

Like all Crane doors, these are built to withstand years of heavy traffic. We start with a heavy gauge stainless steel or steel subframe to ensure sturdiness throughout the life of the door. Finish options of stainless steel, bronze (satin or mirror finish or custom) and aluminum (anodized or painted finish) are welded to ensure long-term durability. Your design options are

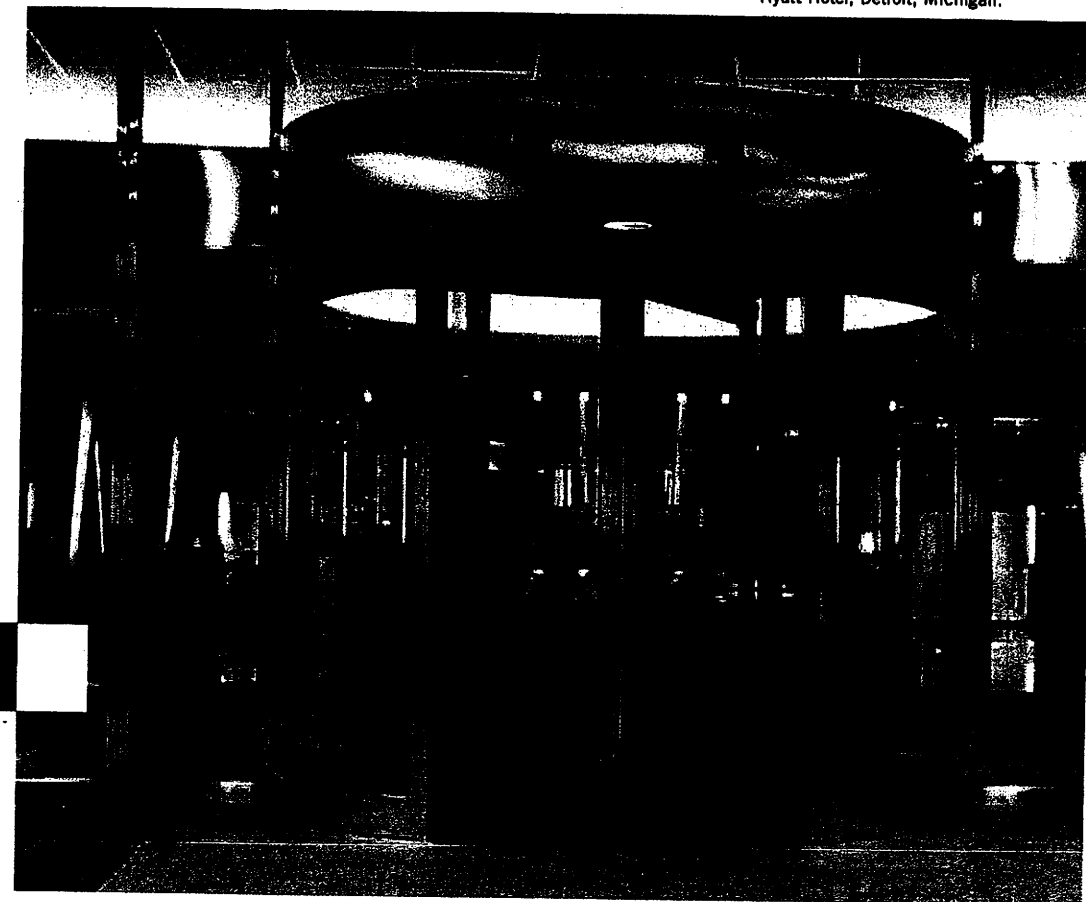

Hyatt Hotel, Detroit, Michigan.

virtually limitless. Our artisan assemblers will customize the door's finish to your exacting specifications. Select from an assortment of accessories and custom configurations to create a door that matches the originality of your design.

### Good looks are just the beginning

Large Diameter Doors from Crane can include our patented Bookfold Collapse

Lock, which prevents bookfolding during high winds or stack conditions unless an alarm is triggered. Additionally, safety detection devices are used in accordance with ANSI/BHMA A156.27-2003.

Doors can be set up and operated in continuous rotation or in response to push plates or motion sensors that will activate or slow door rotation, depending on the need. For added safety, we use

horizontal muntins instead of push bars to create two divided lights and eliminate a catch hazard.

Our Large Diameter Revolving Doors use Crane's robust power drive unit with a 90 V.D.C. motor to rotate the door and control its speed. It is engineered to provide steady, dependable door motion.

Leading the world  
in technology, style  
and performance

Crane has more than 60 years of experience designing, fabricating and installing revolving doors worldwide. We've earned our reputation as the nation's leading supplier of revolving doors by consistently delivering outstanding performance and aesthetic beauty.

In the hands of the craftsmen at Crane, metal and glass are worked into something more than revolving doors. These materials become a bold visual statement that reflects each architect's unique vision and becomes the focal point of any building.

Engineers at Crane have perfected operating hardware that ensures smooth and reliable operation. Features such as our heavy-duty bookfold mechanism offer safety that meets or exceeds national standards.

Built with painstaking attention to detail, our custom revolving doors meet your most demanding

specifications. From the first revolution to the millionth, you can depend on Crane to provide the ultimate in revolving door function and quality.

Crane Security and Large Diameter Revolving Doors have provided years of reliable performance on buildings worldwide, including:

- Retail stores
- Hotels
- Government structures
- Institutional buildings
- Hospitals and healthcare facilities
- Commercial buildings
- Restaurants
- Sports stadiums

**Guarantee**

One year on all parts except glass. Three years on doors installed by a Crane factory authorized installer and serviced annually by a Crane factory representative. Excluding glass and normal wear on weathersweeps and push bars.

J. J. SPANSK.

Crane Revolving Doors  
924 Sherwood Drive  
Lake Bluff, IL 60044  
Phone: 800.942.7263  
or 847.295.2700  
Fax: 847.295.5288  
www.cranedoor.com  
sales@cranedoor.com

A DORMA Group Company  
© 2004 Crane Revolving Door  
Company, Inc.  
Printed in U.S.A.