



KING COUNTY

1200 King County Courthouse
516 Third Avenue
Seattle, WA 98104

Signature Report

Motion 16050

Proposed No. 2021-0455.1

Sponsors Dembowski

1 A MOTION acknowledging receipt of a preliminary water
2 taxi expansion progress report, in response to the 2021-
3 2022 Biennial Budget Ordinance, Ordinance 19210,
4 Section 113, Proviso P3.

5 WHEREAS, the 2021-2022 Biennial Budget Ordinance, Ordinance 19210,
6 Section 113, Proviso P3, states that \$1,000,000 of the funds appropriated to transit from
7 the public transportation operating fund shall not be expended or encumbered until the
8 executive transmits a preliminary and a final water taxi expansion progress report
9 detailing progress on route planning and motions acknowledging receipt of the
10 preliminary and final reports are passed by the council, and

11 WHEREAS, the King County executive has transmitted to the council the
12 preliminary water taxi expansion progress report, and

13 WHEREAS, the report is submitted by the Metro transit department's marine and
14 mobility divisions to fulfill the first of the proviso's reporting obligations;

15 NOW, THEREFORE, BE IT MOVED by the Council of King County:

Motion 16050

- 16 The council acknowledges receipt of the Preliminary Water Taxi Expansion
17 Progress Report, Attachment A to this motion.

Motion 16050 was introduced on 1/11/2022 and passed by the Metropolitan King County Council on 3/1/2022, by the following vote:

Yes: 9 - Balducci, Dembowski, Dunn, Kohl-Welles, Perry,
McDermott, Upthegrove, von Reichbauer and Zahilay

KING COUNTY COUNCIL
KING COUNTY, WASHINGTON

DocuSigned by:

7E1C273CE9994B6...
Claudia Balducci, Chair

ATTEST:

DocuSigned by:

8DE1BB375AD3422...
Melani Pedroza, Clerk of the Council

Attachments: A. Preliminary Water Taxi Expansion Progress Report, November 29, 2021

Preliminary Water Taxi Expansion Progress Report

November 29, 2021



King County

I. Contents

II.	Proviso Text.....	3
III.	Executive Summary	4
IV.	Background.....	5
V.	Report Requirements.....	6
A.	Shoreside Preliminary Design	6
B.	Route Planning.....	11
King County Policies & Plans	11	
Methodology & Assumptions.....	13	
Level of Service	15	
Network Analysis.....	17	
C.	Equipment Specification	30
Methodology & Assumptions.....	30	
Propulsion Analysis.....	31	
D.	Preliminary Capital and Operating Budgets.....	39
E.	Additional Considerations to Prepare for Implementation of the Routes	40
Stakeholder Engagement	41	
VI.	Conclusion/Next Steps.....	41
VII.	Appendices	41

II. Proviso Text

The King County Council (“Council”) on November 17, 2020 unanimously adopted ordinance 19210¹, a final \$12.59 billion budget for the 2021-22 biennium, including Section 113, Transit, Proviso P3 and Expenditure Restriction ER2:

PROVISO P3:

Of this appropriation, \$1,000,000 shall not be expended or encumbered until the executive transmits a preliminary and a final water taxi expansion progress report detailing progress on route planning and motions that should acknowledge receipt of the preliminary and of the final reports and motions acknowledging the preliminary and final reports are passed by the council. Each motion should reference the subject matter, the proviso's ordinance number, ordinance section and proviso number in both the title and body of the motion.

The preliminary and a final water taxi expansion progress reports shall include a discussion of the progress on the planning activities identified in Expenditure Restriction ER2 of this section, including, but not limited to, shoreside preliminary design, route planning, equipment specification, preliminary capital and operating budgets and other details necessary to prepare for implementation of the routes by the council.

The executive should electronically file the preliminary report and motion required by this proviso no later than November 29, 2021, and the final report and motion required by this proviso no later than June 30, 2022, with the clerk of the council, who shall retain an electronic copy and provide an electronic copy to all councilmembers, the council chief of staff and the lead staff for the mobility and environment committee, or its successor.

ER2 EXPENDITURE RESTRICTION:

Of this appropriation, \$500,000 shall be expended or encumbered solely for operational planning for previously studied water taxi expansion routes originating in Kenmore and Shilshole. The planning shall include, but not be limited to, shoreside preliminary design, route planning, equipment specification, preliminary capital and operating budgets and other details necessary to prepare for implementation of the routes by the council.

¹ [King County 2021-22 Biennial Budget, Section 113, Transit](#)

III. Executive Summary

This report is a preliminary response to a proviso in the 2021-2022 adopted budget, Ordinance 19210, Section 113, Transit, Proviso P3 directing the Executive to transmit a report on water taxi expansion progress for previously studied water taxi expansion routes originating in Kenmore and Ballard. This includes technical analysis and stakeholder engagement around shoreside preliminary design, route planning, equipment specification, preliminary capital and operating budgets, and other details necessary to prepare for implementation of the routes by the Council. The scope of this proviso response will not include how implementation of these routes would be prioritized across all King County services. This preliminary report details assumptions and technical work completed to date; further details will be included in the final report, to be transmitted to the Council as directed in the proviso no later than June 30, 2022.

At this stage of work, terminal improvements and transit network connections are being identified at the landing sites proposed in previous work. The Kenmore route landing sites would be the Lakepointe development site in Kenmore and the University of Washington Waterfront Activity Center (UW WAC) in Seattle. The Ballard route landing sites would be Shilshole Marina in the Ballard neighborhood of Seattle and the Seattle waterfront Pier 50. Additional engagement with landing site owners will be required.

Lakepointe: The site currently has no in-water or uplands terminal infrastructure and connections to transit would require additional multimodal improvements. Several bus routes could be revised to better serve the landing site.

UW WAC: The landing site would be adjacent to the Sound Transit University of Washington Link light rail station; however, uplands multimodal infrastructure and redevelopment of an existing in-water dock would be needed.

Shilshole: The landing site would have existing terminal infrastructure but limited network connectivity with no transit service within a ¼ mile walkshed as well as limited multimodal access. A fixed route water taxi shuttle would be needed to connect riders between central Ballard and Golden Gardens Park.

Pier 50: Pier 50 docking capacity is limited by two King County routes and two Kitsap County routes. The addition of a new route would require additional docking capacity. The landing site would have good access to transit and multimodal connections so no additional network changes would be needed.

Adopted King County policies such as the King County Mobility Framework, King County Equity and Social Justice Strategic Plan, King County 2020 Strategic Climate Action Plan, as well as policies being updated in coordination with the Council such as the Service Guidelines and Metro Connects were used to assess route planning and establish service profiles for both expansion routes. The service profiles were set to meet a minimum of 1-hour frequencies, 12-hour spans of service, and an increase in service during the summer sailing season. Hourly service aligns with guidance for other fixed-route transit options and increases opportunities to integrate with Metro's transit network. It also better meets the Service Guidelines' guidelines for facilitating connections between modes, serving multiple purposes, and being easy to understand. In meeting these guidelines, the Ballard route would operate with one

vessel while the Kenmore route would require two vessels to meet the desired 1-hour frequency. As a result of the second vessel, the Kenmore route could operate at greater frequencies, every 40 minutes, which is assumed in the route profiles.

Preliminary vessel specifications, propulsion technology, and related design requirements were developed as a part of this phase of work. As proposed in the previous work, a vessel size with a passenger load of 150 and a cruising speed of 28 knots was selected to meet estimated demand. Electrical capacity to meet the load requirements of a single run on a fully electric plug-in ferry would not be met within the specified dwell time of the potential ferry service schedules and would require terminal battery storage. However, a plug-in hybrid system could be accommodated without terminal battery storage. A plug-in hybrid diesel-electric ferry technology is deemed most appropriate for the Kenmore and Ballard routes for costing and further technical analysis. As battery and hydrogen fuel cell technology evolve, the feasibility of alternative zero-emission propulsion technologies will increase. Metro will continue to consider alternative technologies in fleet choices to align with policies such as the Strategic Climate Action Plan to reduce emissions.

Additional constraints around battery storage capacity, terminal electrical equipment, and electrical grid capacity would impact capital and operating costs. A propulsion technology baseline will be included in the final report for costing comparisons. This baseline will assume that the new Kenmore and Ballard services would be implemented with the propulsion technology that is currently used by the rest of the water taxi system, conventional diesel. The cost baseline will be produced for comparative purposes, with the plug-in hybrid being the propulsion method deemed most promising by the propulsion analysis.

This preliminary report represents the working assumptions and initial reporting on technical work for implementation of water taxi expansion routes. These efforts require additional technical work on shoreside and vessel design, network planning, engagement with stakeholders, and detailed capital and operating costing.

IV. Background

Department Overview: The King County Ferry District (KCFD) was founded in 2008, and year-round passenger-only ferry (POF) service from downtown Seattle to West Seattle and Vashon Island began in 2010. Governance by the King County Council began in 2015. The Marine Division, which currently operates the King County water taxi routes, joined the King County Metro Transit Department (Metro) in 2019.

Historical Context: As part of the state approved business plan used to form the KCFD, provision of POF service was planned to grow over time. In mid-2009, the KCFD began to study demonstration routes on Puget Sound and Lake Washington, but by late 2009 the KCFD ended the study in response to the economic recession. The Council directed the Marine Division, through a proviso in the 2015-2016 adopted budget, to revisit the 2009 study and expand the analysis to incorporate potential new long-term, passenger-only route service expansion opportunities. That effort resulted in a Final Report on Ferry Expansion Options for Marine Division, which identified both the Kenmore and Ballard routes as top potential expansions and was approved by Motion 14561 in 2015. The Council then directed the Marine Division, through two separate proviso requests in the 2019-2020 adopted budget, to continue planning and implementation work on both a Kenmore and Ballard expansion water taxi route. The 2015

study and subsequent 2020 proviso work is the starting point from which this proviso report was developed. Furthermore, a 2020 Puget Sound Regional Council (PSRC) Ferry Study, published in 2020 identified opportunity and interest in additional regional ferry service into the downtown Seattle waterfront and identified the Kenmore to Seattle route as ranking 6 of 18 routes identified in that report.

Current Context: Metro policy, such as the Service Guidelines, Metro Connects, and the Strategic Plan guide investment priorities in support of a regional mobility network and to better advance equity and environmental sustainability through Metro’s operations and service growth. While the implementation of a Kenmore or Ballard water taxi route would advance County goals of providing access to public transportation and help reduce greenhouse gas emissions in the region, the scope of this proviso response does not include how these new routes would be prioritized across all King County Metro public transportation services. Additionally, economic conditions will require further analysis of how the Kenmore or Ballard route would align with the department’s priorities for both capital and operating programs in the context of future funding, as well as how these align with partner agency priorities.

Report Methodology: Metro’s Marine Division and Mobility Division developed the approach for the proviso response. The two Metro divisions jointly developed a scope of work to meet the requirements and identified key staff within each division to develop the response. Additionally, Metro retained the services of a passenger ferry consultant, KPFF Consulting Engineers – Marine Transit Consulting Group and their subconsultants to provide technical support, analysis, and development of technical reports. The diverse team, including representatives from Metro’s partnerships and engagement team, worked together with the consultant to complete the work in a stepped approach. This methodology allowed for an assessment of the many characteristics of POF service as well as the path toward implementation and clearly identifies opportunities and constraints of POF service. The scope of work to properly respond to the proviso request used the findings and recommendations from the 2015 and 2020 studies as a basis for the technical work in further understanding implementation of both the Kenmore and Ballard expansion routes.

V. Report Requirements

This section is organized to align with the proviso request to detail information around planning for previously studied water taxi expansion routes originating in Kenmore and Ballard. Specifically, the proviso requests detail around shoreside preliminary design, route planning, equipment specification, preliminary capital and operating budgets, and other details necessary to prepare for implementation of the routes by the Council. Metro’s Marine and Mobility Divisions worked with the consultant and subconsultants to perform technical analysis and develop the following responses to these requirements.

A. Shoreside Preliminary Design

This section details methodology, assumptions, and preliminary work for shoreside design for the new routes as requested in the proviso.

Landing Site Assumptions

For the Ballard route, the assumed landing sites would be Ballard’s Shilshole Marina and the existing King County water taxi terminal at Pier 50 located on the downtown Seattle waterfront. Figure 1 shows

the assumed Ballard routing and landing sites. For the Kenmore route, the assumed landing sites would be the Lakepointe development site in Kenmore and the UW WAC. Figure 2 shows the assumed Kenmore routing and landing sites.

These landing site assumptions align with previous planning efforts. Pier 50 was selected as it is home to current King County water taxi services. Shilshole Bay Marina is operated by the Port of Seattle and provides some existing infrastructure that would allow for easier implementation of a new route. The Lakepointe development site is the preferred landing site by the City of Kenmore and could also be utilized for vessel maintenance and tie-up. The UW WAC was selected for its numerous transit connections, particularly Link light rail to downtown Seattle and Northgate and bus options to many other destinations.

Figure 1. Ballard routing and landing sites

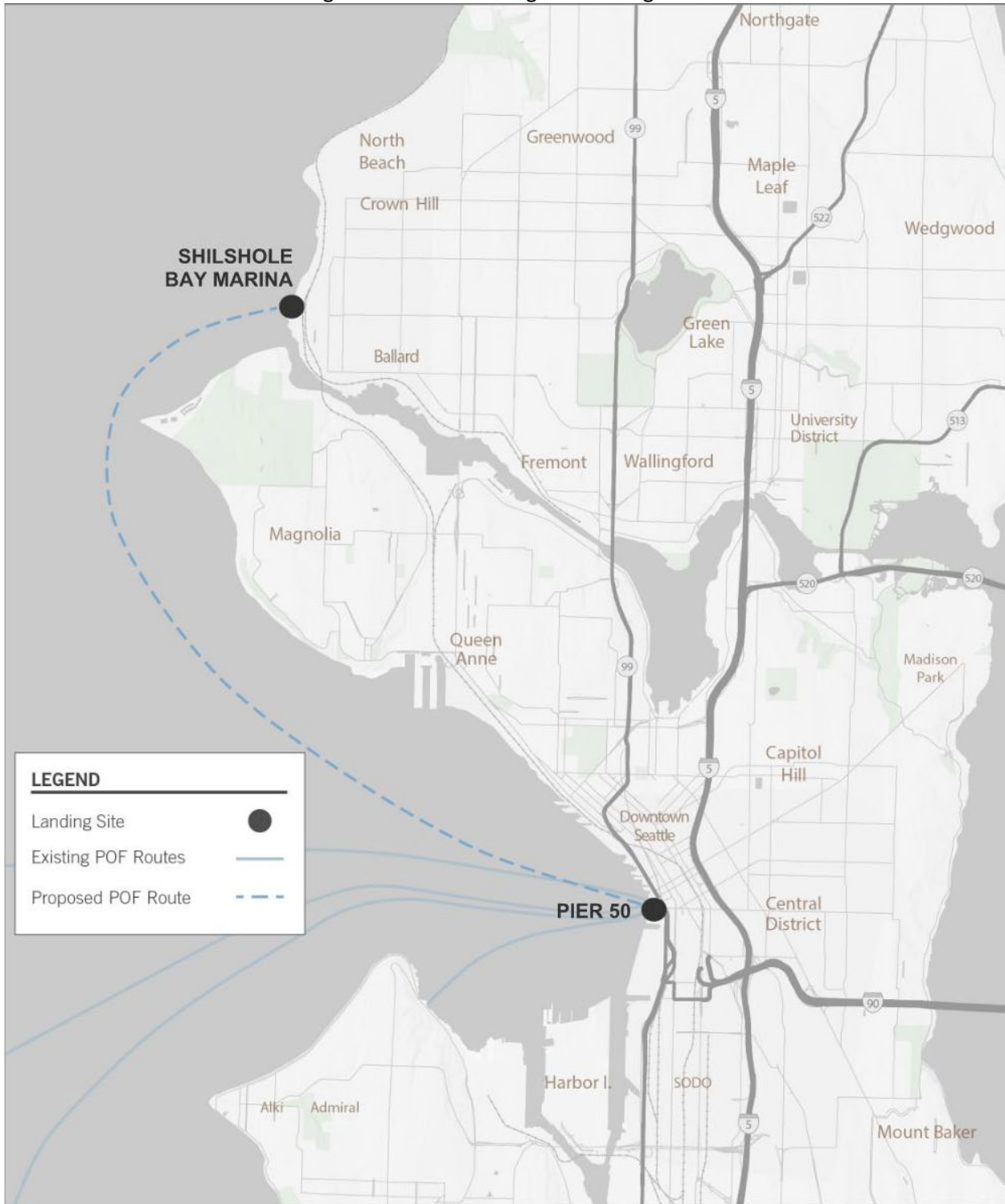
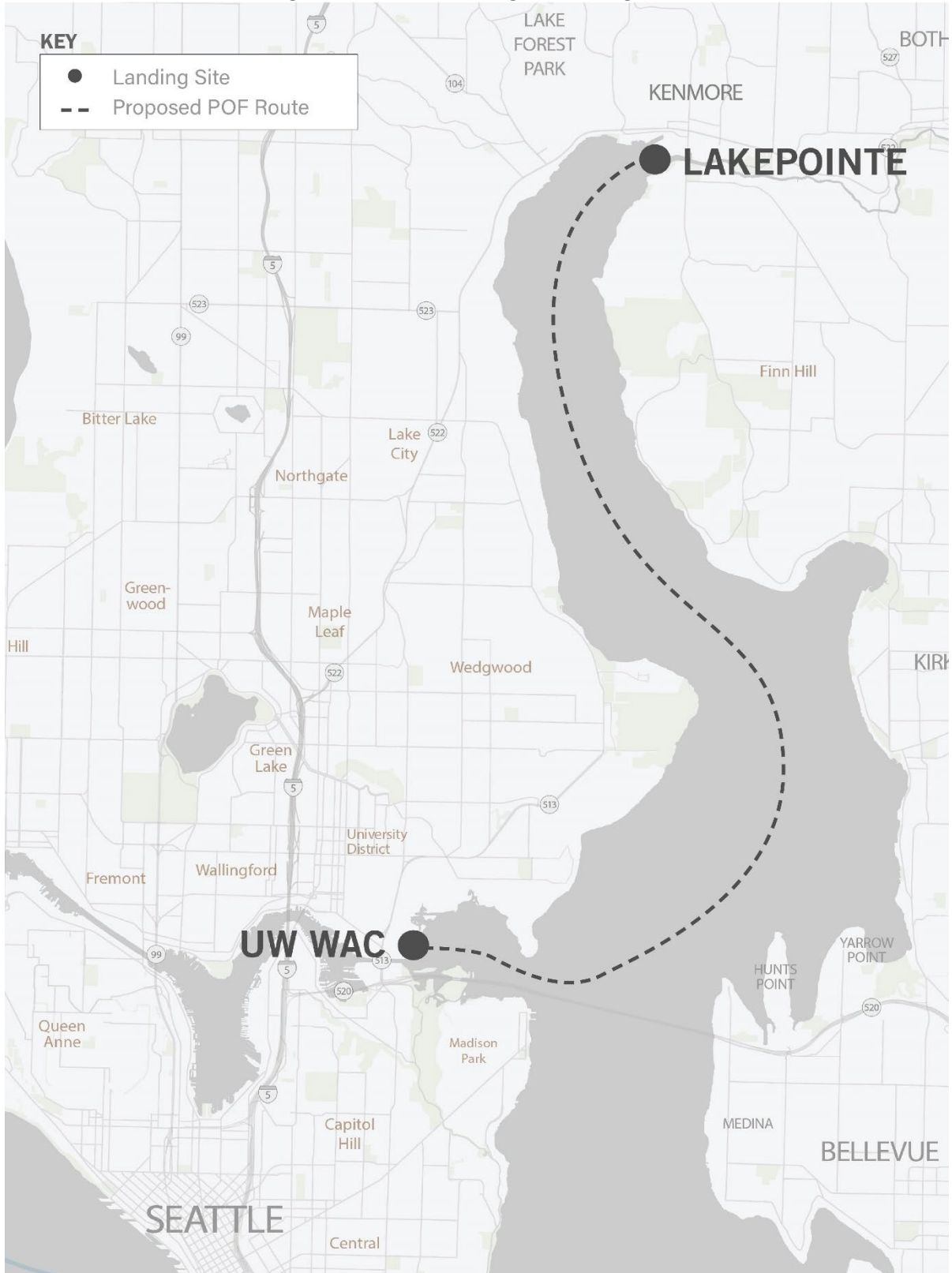

Figure 2. Kenmore routing and landing sites



Maintenance Facility Assumptions

For the Ballard route, the existing King County water taxi maintenance facility at Pier 48 could be utilized for routine maintenance activities. Shipyard maintenance activities assumed vessel drydocks and hull/out-of-water maintenance with labor, materials, and ancillary costs being estimated. Routine terminal maintenance activities such as minor repairs and cleaning were also assumed.

For the Kenmore route, though the same maintenance activities were assumed, a new maintenance facility would need to be planned to avoid the inefficiencies of travelling via the Hiram M. Chittenden Locks to and from the existing Pier 48 maintenance barge for routine maintenance. The maintenance location was assumed to be at the new Lakepointe terminal where additional space and capital investment would be dedicated to creating the needed maintenance facility.

Pier 50 Capacity

The current Pier 50 facility supports the existing King County water taxi routes to West Seattle and Vashon Island and supports two of the three Kitsap Transit Fast Ferry routes. With its two operating slips, the facility is currently operating at capacity, particularly during the commute periods when services run more frequently. An additional float would be needed to support any additional service given the four routes that currently operate out of this location and the current and anticipated ridership demand in the peak periods.

The limited capacity at the current facility and the strong desire for additional POF services to the downtown Seattle waterfront has been a growing matter of interest for many, as outlined in the 2020 PSRC Passenger-Only Ferry Study. Additionally, Kitsap Transit is currently undertaking a Siting Study to identify a long-term solution to current capacity constraints on their POF services. The findings of the Siting Study and whether Kitsap Transit would relocate POF operations from Pier 50 are not yet known, and this proviso response does not speculate upon them.

This preliminary and final report will not evaluate the potential capital infrastructure needed to support any additional routes landing at Pier 50 beyond the Ballard route, nor will it evaluate what is needed to support the potential of expanded or more frequent service on any of the existing water taxi and/or Fast Ferry routes that currently land at Pier 50, though these are areas that should be analyzed to support successful integrated waterborne transit planning along the downtown Seattle waterfront.

Instead, for the purposes of costing, this preliminary and final report will assume that, with all conditions remaining the same at Pier 50, a Ballard POF route could not be added to the facility without constructing a new float with additional operating slips. This was evidenced by the start-up of the Southworth Fast Ferry route leading to the relocation of the Bremerton Fast Ferry route to Pier 54 to ensure sufficient landing space and maintain schedule.

The recently completed habitat beach to the South also presents limitations on in-water and over-water expansion at the terminal. Float expansion would need to be designed to avoid the habitat beach extent and maintain any overwater footprint within the harbor line.

Terminal Improvements

Terminal improvement needs vary by landing site location. In Kenmore, the Lakepointe landing site currently has no in-water or uplands terminal infrastructure and connections to transit would require

additional improvement. At the University of Washington uplands infrastructure would be required, as well as redevelopment of an existing in-water dock. Shilshole and Pier 50 both have existing infrastructure; however, some improvements would be needed due to the expansion of services at those existing facilities.

Electrical Capacity

Electrical power and grid capacity infrastructure are limited at and near the terminal locations. Depending on the electrical loads needed for future POF routes and the timing of the route implementation, additional electrical grid infrastructure could be needed. Early negotiation with the local utilities (Seattle City Light and Puget Sound Energy) would be required as the process to expand grid electrical capacity could take up to five years. Additionally, as more industries seek to reduce emissions via electrification, electrical grid capacity could become even further constrained. Local utilities are seeking to conduct additional capacity planning, and incorporating water taxi expansions into these plans could assist future implementation efforts.

Landing Site Access

The terminals would be accessed by pedestrian, bicycle, and vehicle traffic by way of personal vehicle, rideshare, or potential fixed-route bus or shuttle drop-off. Access enhancement to accommodate these modes differs by terminal location. Preliminary site layouts that include all considerations of landside and marine access, capacities, and terminal infrastructure elements, and their costs, needed to support service will be included in the final report.

B. Route Planning

This section details methodology, assumptions, and preliminary work for route planning and network integration analysis for the expansion routes as requested in the Proviso.

King County Policies & Plans

The assumptions and technical analysis around route planning and implementation are guided by adopted King County policies. Some of the policy documents guiding this work have been updated by Metro and proposed by the King County Executive to King County Council. These include the King County Metro Strategic Plan for Public Transportation, Metro Connects, and the Metro Service Guidelines. The ongoing work of these policy documents have influenced the work to date, however further details of these policies, following Council adoption, and their subsequent influence on the technical work will be included in the final report. Key policies guiding this work include:

King County Equity and Social Justice Strategic Plan

The King County Equity and Social Justice (ESJ) Strategic Plan is a blueprint for change, mutually created by King County employees and community partners. The shared vision is to create “[a] King County where all people have equitable opportunity to thrive.” The ESJ Strategic Plan directs King County to invest upstream and where needs are greatest to address root causes and be pro-equity. For Transportation and Mobility, efforts are focused around:

1. Investments in service improvements
2. Investments in community partnerships
3. Investments in the places and people with greatest needs
4. Leveraging the County’s role as a major employer

King County 2020 Strategic Climate Action Plan

King County's Strategic Climate Action Plan (SCAP) is a five-year blueprint for County climate action, integrating climate change into all areas of County operations. The core sections, reducing greenhouse gas (GHG) emissions, sustainable and resilient frontline communities, and preparing for climate changes, are guided by the following principles:

- Innovate equitably and sustainably
- Ensure safety
- Encourage dense, affordable housing in urban areas near transit
- Improve access to mobility
- Provide fast, reliable, integrated mobility services
- Support our workforce
- Align our investments with equity, sustainability, and financial responsibility
- Engage deliberately and transparently

Transportation is the region's largest source of GHG emissions, and the SCAP outlines focus areas to increase regional transit ridership, reduce total vehicle miles, and adopt clean fuels standards to reduce transportation-fuel GHG emissions.

This policy was informed by Metro's Mobility Framework and recommendations were incorporated into the proposed policy updates for King County Metro's Strategic Plan, Metro Connects, and Service Guidelines.

King County Mobility Framework

Metro's Mobility Framework envisions a regional network of traditional and new transportation services that gets people where they want to go, when they want to get there, while contributing to healthy communities, a thriving economy, and a sustainable environment. The following guiding principles set a vision for how Metro and partners can achieve a regional mobility system that is innovative, integrated, equitable, and sustainable.

- Invest where needs are greatest
- Address the climate crisis and environmental justice
- Innovate equitably and sustainably
- Ensure safety
- Encourage dense, affordable housing in urban areas near transit
- Improve access to mobility
- Provide fast, reliable, integrated mobility services
- Support our workforce
- Align our investments with equity, sustainability, and financial responsibility
- Engage deliberately and transparently

King County Metro Strategic Plan for Public Transportation 2011-2021

The Strategic Plan outlines Metro's goals, the strategies and objectives to achieve them, and measures to determine if the goals are being met. The goals are related to the following:

1. Safety
2. Human potential
3. Economic growth and built environment
4. Environmental sustainability

5. Service excellence
6. Financial stewardship
7. Public engagement and transparency
8. Quality workforce

Metro's Strategic Plan has been updated by Metro and proposed updates have been transmitted from the King County Executive to King County Council. The existing policy and any changes approved by the Council will be considered in this ongoing technical work.

King County Metro Long-Range Plan 2016 (METRO CONNECTS)

Metro Connects is Metro's vision for bringing more and better transit service to King County. The plan is guided by Metro's values of safety, excellent customer service, sustainability, equity and social justice, partnerships, and innovation.

Adopted in 2017, Metro Connects does not currently address water taxi service. Metro Connects has been updated by Metro and proposed updates have been transmitted from the King County Executive to King County Council. The proposed update includes additional information on future water taxi service. Target service levels established in the proposed update were used to determine proposed service levels and spans of service for the Kenmore and Ballard routes. The existing policy and any changes approved by the Council will be considered in this ongoing technical work.

King County Metro Service Guidelines 2015 Update

Metro uses service guidelines to evaluate, design, and modify transit services to meet changing needs and to deliver efficient, high-quality service. The guidelines help make sure that decision-making and recommendations to policy makers are objective, transparent, and aligned with the region's goals for public transportation. Use of the guidelines fulfills Metro's Strategic Plan Strategy 6.1.1, "Manage the transit system through service guidelines and performance measures." The service guidelines establish criteria and processes that Metro uses to analyze and plan changes to the transit system.

The current Service Guidelines do not include information on water taxi service. The Service Guidelines has been updated by Metro and proposed updates have been transmitted from the King County Executive to King County Council. The proposed update includes criteria and processes for evaluating, designing, and modifying existing water taxi service. The existing policy and any changes approved by the Council will be considered in this ongoing technical work.

[Methodology & Assumptions](#)

Time Competitiveness and Demand

For users to select the ferry as a mode of transit, the ferry must be competitive with other currently available transit options. Route profiles were developed to generate feasible travel times and evaluate how competitive the new ferry routes would be in comparison to other existing modes. Both the Kenmore and Ballard POF routes, as profiled, provide similar travel times that would be competitive with existing transit options.

Ridership demand was developed as part of the previous proviso effort. The existing ridership estimates will be used as a baseline in the upcoming work effort around costs. Demand is based on the PSRC SoundCast model, which is unconstrained by particular sailing times and includes assumptions regarding

recreational ridership potential that were based on trends observed in the West Seattle water taxi route. The unconstrained ridership model provided an understanding of the high-end number of commute riders that could be expected. However, recreational ridership potential is difficult to predict.

These ridership estimates produced by the model were then used to help develop service schedules and properly size the potential service vessels. Ridership will be used in the financial analysis but is not the only driver of service schedules, which were also informed by the factors detailed below aligning with Metro service policies. Service schedules based on demand forecasting and trends observed in existing water taxi routes were used in previous studies and will be used as a baseline comparison in this work as needed.

Frequency of Sailings

The proposed update of Metro Connects, Metro's long-range plan, specifies that water taxi services should run at least every hour, and service for both routes was designed to align with this vision. Hourly service aligns with guidance for other fixed-route transit options and increases opportunities to integrate with Metro's transit network. It also better meets the Service Guidelines' developing service guidelines for facilitating connections between modes, serving multiple purposes, and being easy to understand.

For Ballard service, hourly service could be met with one vessel, but more frequent service could not. To minimize cost while maintaining effective service, an hourly service schedule supported by one vessel was assumed.

In the case of Kenmore, due to the length of the route, hourly service could only be supported by two vessels operating simultaneously. With two vessels, it would be possible to run more frequent service, with sailings departing every 40 minutes. As more frequent service is preferred, particularly for commute periods, all sailings for the Kenmore route were assumed to depart every 40 minutes.

Seasonal Schedules

Current King County water taxi routes see an increase in service and demand during the summer season, which is common for many POF and vehicle ferry operators. To align with this demand pattern, two different service schedules were assumed for each route: one for the lower-demand winter season and one for the higher-demand summer season.

Experience from existing water taxi routes and other ferry services indicates that, to be competitive and provide sufficient options for commute riders, three round trips per commute period [6:00 to 9:00 am for the AM commute, and 3:00 to 6:00 pm for the PM commute] must be provided. As a result, commute-only service is assumed to provide, at minimum, this level of round trips.

Six months of the year were assumed to follow the winter schedule while the remaining six months of the year were assumed to follow the summer schedule. This six-month split aligns with the existing West Seattle water taxi schedule.

Service Predictability

Metro Connects outlines that water taxi services should have between eight and 18 hours of service a day while fixed-route services should have a minimum of 12 hours of service a day. To ensure predictable service that is easy for riders to use, a minimum of a 12-hour service day would be provided, including on winter Saturdays, running approximately 8:00 am to 8:00 pm. The 12-hour winter Saturday service day was included regardless of perceived Saturday winter demand to align with key Metro service guidelines and match service levels of other transit service connecting to the water taxi terminals.

Level of Service

Kenmore Service Schedule

Due to the length of the route, and to meet service level guidelines (hourly frequency), the Kenmore route would require two operating vessels in both the winter and summer months. With two vessels providing service, sailings could depart as frequently as every 40 minutes.

The lower demand Kenmore winter schedule was designed to primarily serve the weekly commute periods with at least three round trips in the AM peak (6 a.m. - 9 a.m.) and three round trips in the PM peak (4 p.m. - 7 p.m.). For the Kenmore route, one additional commute round trip before the AM commute period was added to serve school and hospital employees that work in the UW area with early shift start times. This was in response to feedback received in previous engagement efforts for Metro's North Link Connections Mobility Project.

The winter schedule would also include Saturday service to help meet the needs of non-traditional workers and potential recreational ridership.

The summer schedule for the Kenmore route would be expanded in the mid-day, and weekends to meet anticipated recreational ridership demand. Service would be expanded to all-day seven days a week. Late evening service would be added to the schedule on Friday and Saturday nights to further support recreational and discretionary riders.

Special event service to UW was assumed for ten days out of the year during the winter service schedule, for events such as football games. The extended summer service schedule is assumed sufficient to cover service needs for any special events in that season.

Table 1 summarizes the potential Kenmore service schedule for the 6-month winter and 6-month summer service levels.

Table 1. Kenmore service schedule summary

	Winter	Summer
Vessel Passenger Capacity	150 passengers	150 passengers
Operating Vessels	2 vessels	2 vessels
Backup Vessels	1 vessel	1 vessel
Maximum Service Frequency	40-minute headway	40-minute headway
Commute Service	11 RTs per day: <ul style="list-style-type: none"> • 6 RTs in the AM peak • 5 RTs in the PM peak 	21 RTs per day Mon-Thurs: <ul style="list-style-type: none"> • 6 RTs in the AM peak • 5 RTs in the PM peak • Mid-day service (10 RTs) 26 RTs per day Fridays: <ul style="list-style-type: none"> • Additional late night Friday service (5 RTs)
Saturday Service	• 18 RTs per day	• 21 RTs per day <ul style="list-style-type: none"> • Late night service (3 RTs)
Sunday Service	No service	• 18 RTs per day
Special Events	10 per year	None; extended service schedule assumed to cover special events

Note: Round Trips are abbreviated as "RTs." Weekend schedule could be reduced to one-hour headways with fewer daily RTs.

Ballard Service Schedule

The Ballard route could meet an hourly service schedule year-round with one operating vessel.

The potential Ballard winter schedule is designed to primarily serve the commute periods during the week, with at least three round trips in the AM peak (6 a.m. - 9 a.m.) and three round trips in the PM peak (4 p.m. - 7 p.m.). The Ballard winter schedule would also include Saturday service to help meet the needs of non-traditional workers and potential recreational ridership.

The summer schedule for the Ballard route assumed service would be expanded to meet increased recreational/discretionary ridership demand. Service would be expanded to all day seven days a week. Late evening service would be added to the schedule on Friday and Saturday nights to further support recreational riders providing service for 15 hours per day.

There would be no special event service for the potential Ballard water taxi route.

Table 2 summarizes the potential Ballard service schedule for the 6-month winter and 6-month summer service levels.

Table 2. Ballard service schedule summary

	Winter	Summer Peak
Vessel Passenger Capacity	150 passengers	150 passengers
Operating Vessels	1 vessel	1 vessel
Backup Vessels	1 vessel	1 vessel
Maximum Service Frequency	1 hour headway	1 hour headway
Commute Service	6 RTs per day: • 3 RTs in the AM peak • 3 RTs in the PM peak	14 RTs per day Mon-Thurs: • 3 RTs in the AM peak • 4 RTs in the PM peak • Midday service (7 RTs) 16 RTs per day Fridays: • Additional late night Friday service (2 RTs)
Saturday Service	• 12 RTs per day	• 15 RTs per day
Sunday Service	No service	• 12 RTs per day
Special Events	None	None

Network Analysis

Kenmore

Existing Conditions

Kenmore is currently served by local and peak-only Metro services as well as Sound Transit services. The transit and bicycle network near the potential Lakepointe landing site is shown in Figure 3. Routes, including frequencies and spans, are shown in Table 3.

Table 3. Transit routes* near the potential Lakepointe landing site

Route	Connections	Frequency*	Span
225	Kenmore P&R – Kingsgate P&R – Totem Lake TC – Lake Washington Technical Institute – Redmond Technology Station	30 minutes	All Day
320	Kenmore P&R – Lake City – Northgate Station – South Lake Union	Nine AM peak trips, eight PM peak trips	Peak Only
322	Kenmore P&R – Lake City – Roosevelt Station – First Hill	Seven AM peak trips, Ten PM peak trips	Peak Only
331	Kenmore P&R – Lake Forest Park – Aurora Village TC – Shoreline CC	20 minutes during the peak, 30 minutes during the day	All Day
342	Aurora Village TC – Lake Forest Park – Kenmore – Bothell – Woodinville – I-405 corridor – Renton TC	Four AM peak trips, Four PM peak trips	Peak Only
372	UW Bothell – Bothell P&R – Kenmore P&R – Lake City – UW Seattle – U District Station	Five-15 minutes during the peak, 15 minutes during the day	All Day
ST 522	Woodinville P&R – UW Bothell – Kenmore P&R – Lake City – Roosevelt Station	15 minutes during the peak, 20 minutes during the day	All Day

*This represents the routes and frequency of trips for the Fall 2021 service change.

Routes 320 and 322 are new and were implemented as part of the North Link Connections Mobility Project in Fall 2021. Other routes in or connections around Kenmore may also be impacted by the ongoing East Link Connections Mobility Project, including Route 342. Any changes from the East Link project would be implemented in 2024.

Figure 3. Existing transit and bicycle connections near the potential Lakepointe landing site.

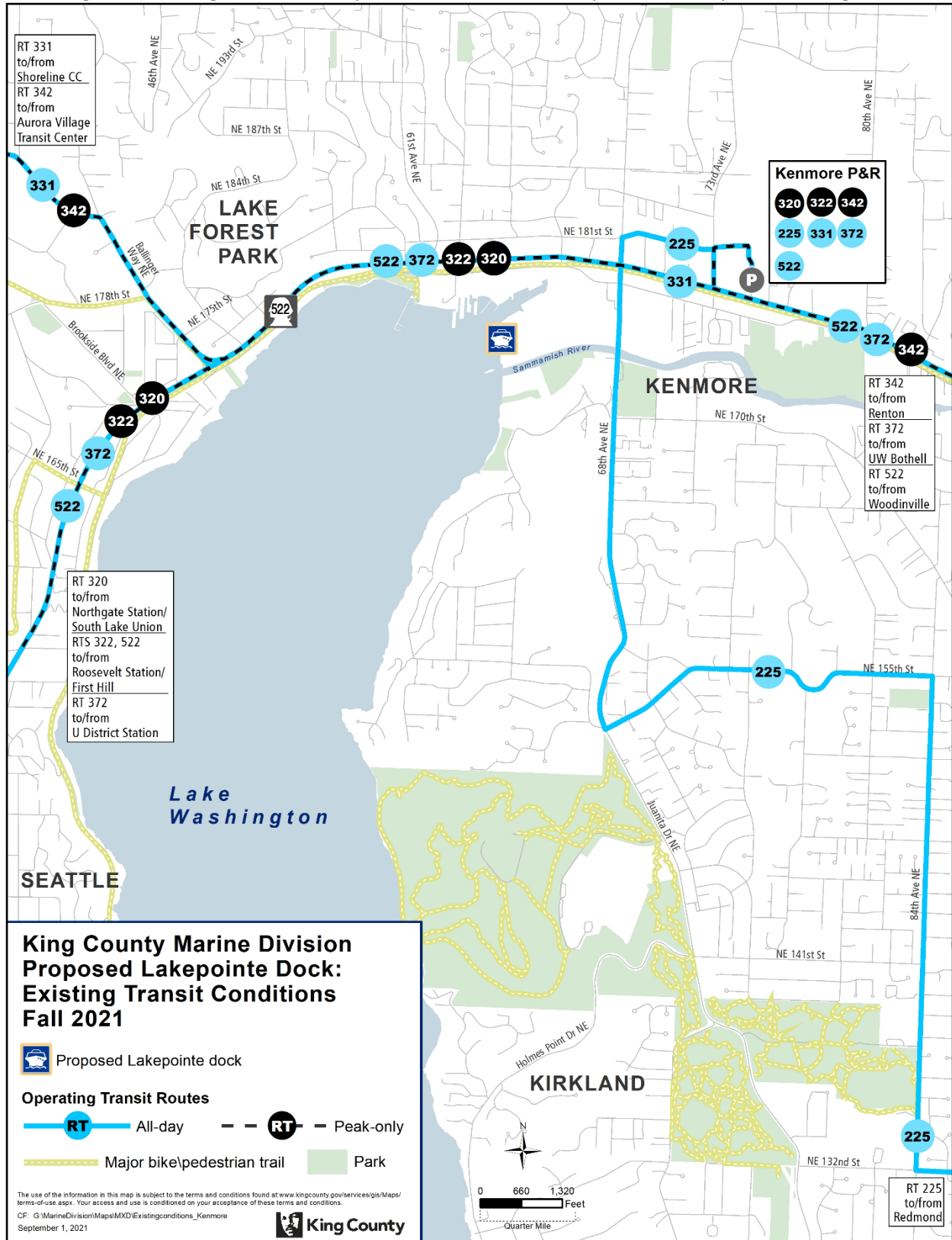

Sound Transit plans to implement Stride BRT along the SR-522 corridor between Bothell and the Shoreline South/148th Link light rail Station after the Lynnwood Link extension is complete. This would replace existing ST Route 522, which operates between Woodinville and Roosevelt Station, connecting to both BRT services on I-405 and Link light rail in Shoreline. Metro's Metro Connects interim network also envisions frequency and span improvements on existing routes, in addition to other network changes. Based on these improvements, the PSRC's Vision 2050 regional planning document identifies Kenmore and Bothell areas as high-capacity transit communities that are considered hubs for employment and population growth.

There are multiple Metro park-and-rides, both Metro owned and leased lots, in the vicinity of the Lakepointe landing site. Table 4 details the permanent Metro park and rides in the area. The future of any existing leased park-and-ride lots are dependent on property owner and Metro needs. The closest permanent park-and-ride, the Kenmore Park-and-Ride, is shown in Figure 3. The figures for 2021 represent the average utilization through the second quarter of the year.

Table 4. Metro managed permanent park and rides near the Lakepointe landing site

Metro-managed permanent P&R Lot	Owner	Total Spaces	2019 Average Utilization	Q2 2021 Average Utilization	Located within 1/2-mile of potential landing site?
Bothell P&R	KC	220	89%	11%	No
Brickyard Road P&R	WSDOT	443	84%	12%	No
Kenmore P&R*	KC	603	92%	8%	Yes
Woodinville P&R	WSDOT	438	53%	6%	No

*A transit-oriented development is planned next to the existing Kenmore P&R, which would add parking stalls.

The Burke-Gilman Trail follows the Lake Washington shoreline to the west and south of the site as shown in Figure 3. To the east is the Sammamish River Trails along the Sammamish River. Together, the two well-established trails offer extensive paved, flat, separated access for long distances. Both can be considered all ages and abilities facilities.

Access from the north is limited and requires crossing multi-lane, high traffic NE Bothell Way/SR-522. The nearest signalized crossing of SR522 to the site is at 68th Avenue NE. A signal is in place on 68th Avenue NE and NE 175th Street for access from the east.

The Lakepointe landing site is in an industrial area with limited to no pedestrian or bike infrastructure on the site itself or from the site to SR-522. The site is adjacent to the Kenmore Air Harbor, an asphalt manufacturing plant, and a concrete mix plant and landscaping supply company.

To the south toward Kirkland, there is no sidewalk or bike lane on 68th Avenue NE over the bridge crossing the Sammamish River. A sidewalk begins on the west side of 68th Avenue NE south of the bridge. Several other roadways to the southwest have marked bike lanes, though moderate to considerable grades. These facilities are likely to be comfortable only for people confident cycling with traffic. The City of Kenmore has planned improvements to bike and walk infrastructure in 2022 as part of the Walkways and Waterways bond and other future improvements outlined in the Pedestrian and

Bicycle Safety Strategy. Neighboring cities, including Bothell and Kirkland, also have planned improvements to their bike and walk infrastructure.

The UW WAC landing site is adjacent to Husky Stadium, within a ¼ mile walk to the University of Washington Link light rail Station and Montlake Boulevard NE and NE Pacific Street with frequent transit service. The transit and bicycle network near the potential landing site at UW WAC is shown in Figure 4. Routes, including frequencies and spans, are shown in Table 5. Only routes that operate along NE Pacific Street and Montlake Boulevard NE are included in the figure and table. There are other routes which operate further from the UW WAC landing site along West Stevens Way NE and NE 45th Street.

Table 5: Transit routes near the potential UW WAC landing site (Fall 2021)

Route	Connections	Frequency*	Span
43	University District – Montlake – Capitol Hill – Downtown Seattle	21 AM peak trips (14 northbound, seven southbound), 17 PM peak trips (four northbound, 13 southbound)	Peak Only
44	Ballard – Wallingford – University of Washington Station	10 minutes during the peak, 12 minutes during the day	All Day
48	Mt. Baker TC – Central District – Montlake – University District	12 minutes during the peak, 15 minutes during the day	All Day
65	Jackson Park – Lake City – University District*	15 minutes all day	All Day
73	Jackson Park – Maple Leaf – University of Washington Station	15 minutes during the peak, 30 minutes during the day	All Day
255	Totem Lake TC – Kirkland – University District	Six-12 minutes during the peak, 15 minutes during the day	All Day
271	Issaquah – Eastgate – Bellevue College – Bellevue Transit Center – Montlake – University District	10-12 minutes during the peak, 15 minutes during the day	All Day
ST 542	Redmond TC – Evergreen Point – University District	20 minutes during the peak, 30 minutes during the day	All Day

*Route 67 only stops on NE Pacific St/Montlake Blvd NE in the northbound direction.

At the potential UW WAC landing site there is complete sidewalk infrastructure throughout adjacent neighborhoods and a well-established network of separated and marked bike or multiuse trails from all directions to the site, including the Burke-Gilman Trail to the north and west; unpaved trail network northeast of the site through Union Bay Natural Area; and Montlake, Arboretum and Portage Bay neighborhoods. See Figure 4.

Bikes and pedestrians share narrow sidewalks on both sides of Montlake Bridge for riders coming from the south. For connections to Link light rail at the adjacent University of Washington Station, there are open bike racks and on-demand lockers available. Bikes can also be carried on all Metro buses and Link light rail cars.

Figure 4. Existing transit and bicycle connections near the potential UW WAC landing site.



Potential changes to connect to water taxi

Metro anticipates that there may be changes needed to the transit network to connect riders to and from the water taxi terminals. Using the potential levels of service, Metro developed the following route proposals and cost estimates to be used in costing and operational planning for this work. These potential changes may be subject to Council approval. Proposed route changes are subject to Council approval except as follows (per King County code 28.94.020):

- Any single change or cumulative changes in a service schedule which affect the established weekly service hours for a route by 25 percent or less.
- Any change in route location which does not move the location of any route stop by more than 1/2 mile.
- Any changes in route numbers.

Fixed Route Changes

Potential changes to fixed-route services were based on the Metro Connects interim network. Connections to and from the Kenmore Park & Ride, SR-522, and the Finn Hill area were prioritized in the potential changes to ensure riders from different areas would have access opportunities to the Lakepointe landing site, in addition to other Metro or Sound Transit services.

Metro Connects routes 1215, between Shoreline Community College and Kenmore Park & Ride, and 3114, between Redmond and the Kenmore Park & Ride, would be extended from their terminal to serve the water taxi as shown in Figure 5. Cost estimates are based on the route extension matching with the seasonal water taxi service levels, meaning these routes would also extend to the Lakepointe landing site when the water taxi is operating. Service levels on routes 1215 and 3114 would be higher than the comparable routes in the current network, however, the cost estimates are based on if the Metro Connects network were implemented. The two routes would have 30-minute frequencies and could be scheduled to provide 15-minute frequency between the landing site and the Kenmore Park-and-Ride. Additional resources would be needed to match planned Metro Connects service levels. The additional resources needed for the route extensions to serve the Lakepointe landing site at Metro Connects service levels are shown in Table 6.

Figure 5. Metro Connects interim network and potential extension of Metro Connects routes 1215 and 3114 to serve the Lakepointe landing site.

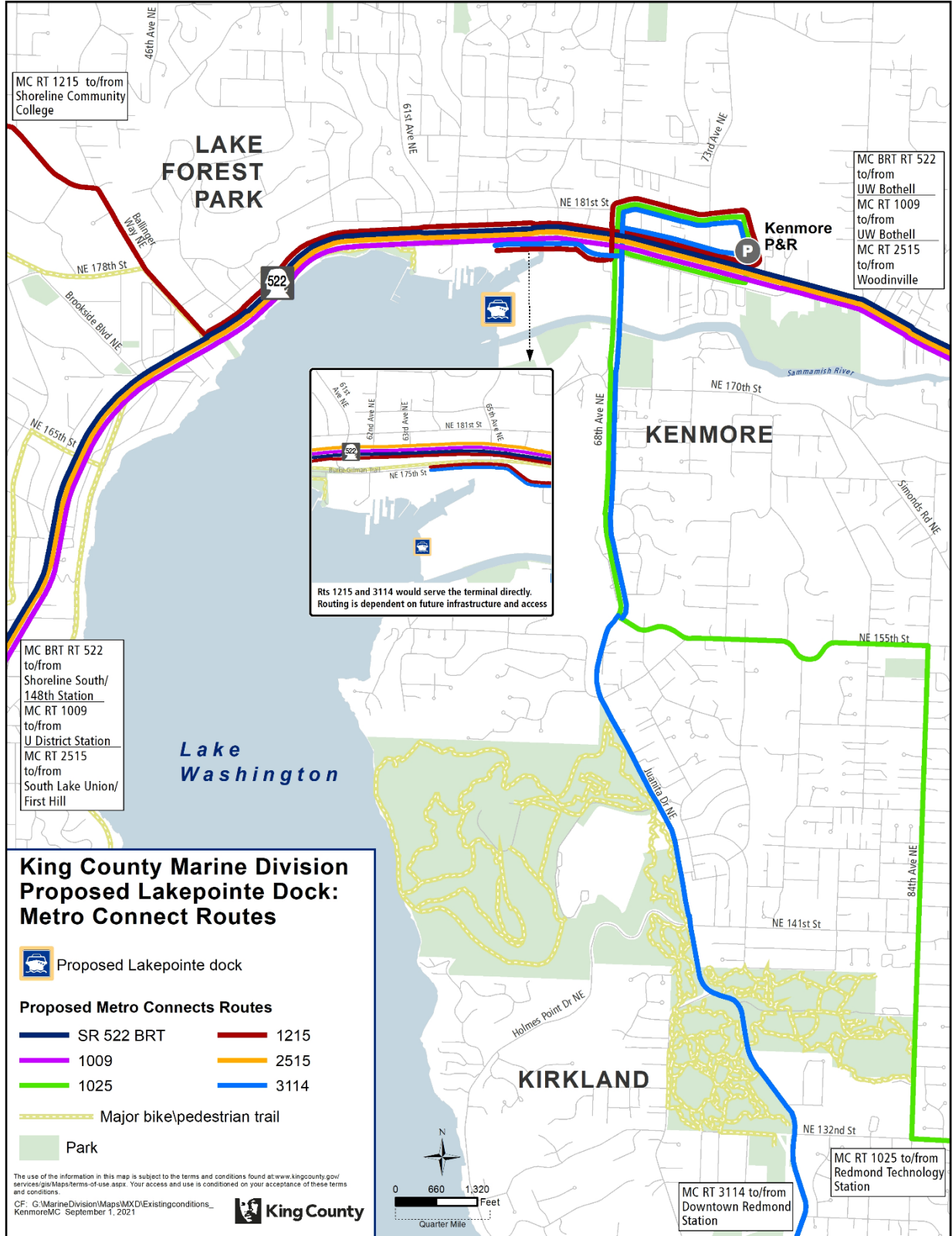

Table 6. Resources to support potential Metro Connects fixed route changes at the Lakepointe landing site

MC Route	Connections	Frequency		Resources Needed	
		Full Route	To Water Taxi	Annual Hours	2021 Dollars
1215	Shoreline CC - North City - Ballinger Way - Lake Forest Park - Kenmore P&R	15 minutes	30 minutes	1,751	\$330,957
3114	Redmond - Education Hill - Totem Lake TC - Juanita - Finn Hill - Kenmore P&R	30 minutes	30 minutes	1,751	\$330,957
				3,503	\$661,913

The costs shown in Table 6 reflect the full cost to operate service (fully allocated rate) in 2021 and do not reflect additional necessary layover and comfort station access to support these revisions. Metro would require layover space for approximately three 60' coaches for all operating hours, which would impact capital and operating costs.

Due to the existing proximity of the UW WAC landing site to the University of Washington Link light rail Station and multiple frequent transit connections in the Metro Connects interim network, there would be no potential network changes near this terminal.

Multimodal Changes

The immediate area around the Lakepointe landing site would require multimodal improvements on-site and to the west and the north, including across SR-522. Because the neighboring businesses are industrial in nature, Metro and partners would need to balance freight, pedestrian, and bike safety and priority in the area. Pedestrian improvements may also be required to provide safe access through existing University of Washington parking lots adjacent to Husky Stadium and closer to the UW WAC landing site. Metro would need to coordinate with the City of Kenmore, the City of Seattle, and the University of Washington on any necessary improvements for multimodal access outside the terminal locations.

Ballard

Existing Conditions

Shilshole Bay Marina is located to the west of downtown Ballard, along Seaview Avenue NW near the Sunset Hill neighborhood. There is no current transit service within ¼ mile walkshed of the potential landing site location. Other parts of Ballard are served by Metro peak-only and all-day routes, including the RapidRide D Line along 15th Avenue NW. Details on frequency and span are shown in Table 7 and transit in the greater Ballard area is shown in Figure 6.

Table 7. Transit routes near the potential Shilshole landing site

Route	Connections	Frequency	Span
15X	Blue Ridge – Crown Hill – Downtown Seattle	Six AM peak trips, Six PM peak trips	Peak Only
17X	Loyal Heights – Downtown Seattle	Five AM peak trips, Five PM peak trips	Peak Only
18X	North Beach – Downtown Seattle	Five AM peak trips, Five PM peak trips	Peak Only
29	Ballard – SPU – Queen Anne – Downtown Seattle	Six AM peak trips, Six PM peak trips	Peak Only
40	Northgate Station – Crown Hill – Ballard – Fremont – South Lake Union – Downtown Seattle	Eight to 10 minutes during the peak, 15 minutes during the day	All Day
44	Ballard – Wallingford – U District Station	10 minutes during the peak, 12 minutes during the day	All Day
45	Loyal Heights – Greenwood – Green Lake – Roosevelt Station – U District Station – UW Campus	10 minutes during the peak, 15 minutes during the day	All Day
D Line	Crown Hill – Ballard – Interbay – Uptown – Downtown Seattle	Six-eight minutes during the peak, 10 minutes during the day	All Day

Figure 6. Existing transit and bicycle connections near the potential Shilshole landing site.

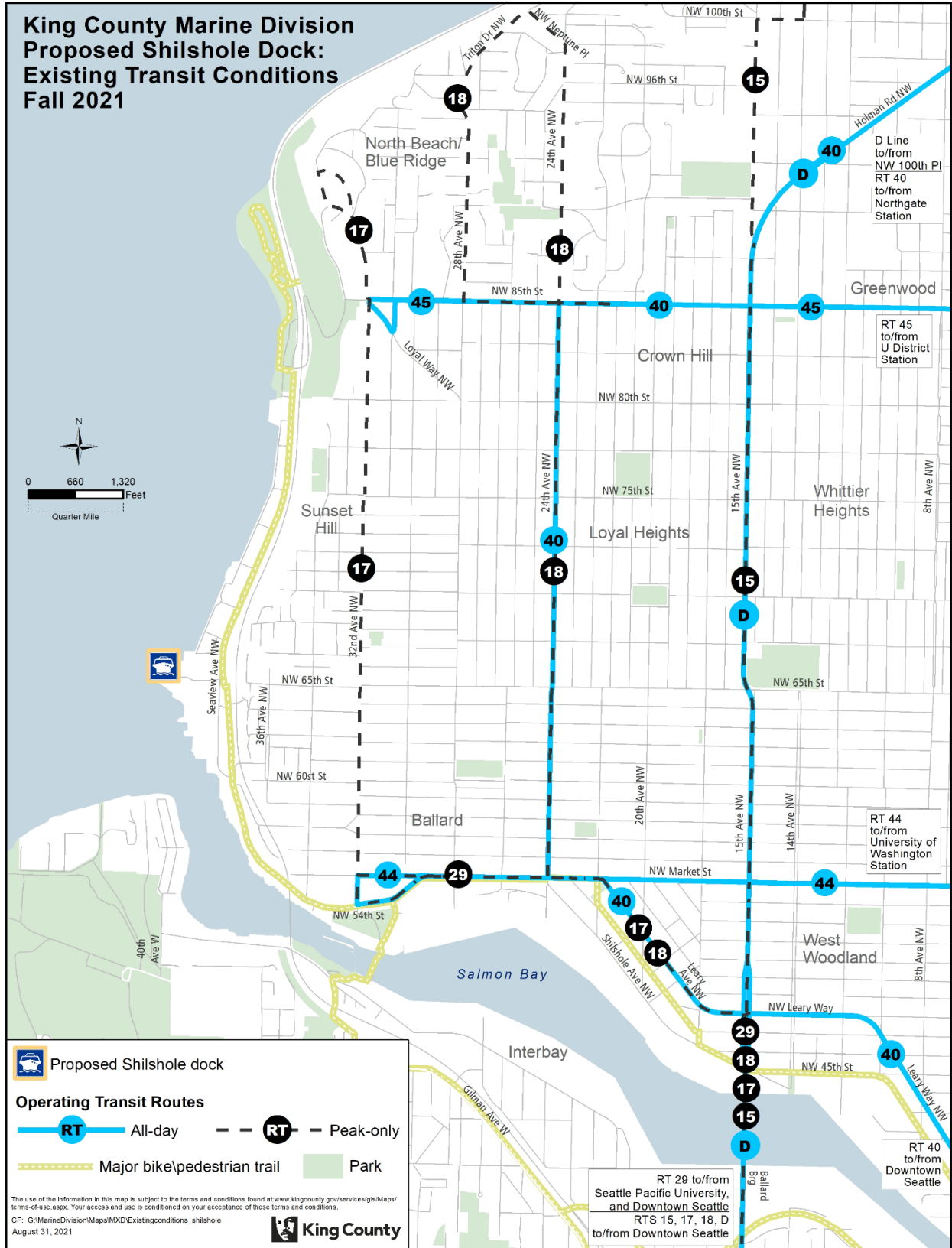

Sound Transit plans to extend Link light rail to Ballard as part of the Sound Transit 3 (ST3) regional transit system plan, approved by voters in 2016. Due to funding uncertainties, implementation is now planned to occur in 2039. The Metro Connects interim network also envisions frequency and span improvements on existing routes, in addition to other network changes that reflect the implementation of Link light rail between Ballard and downtown Seattle.

There are no Metro managed or leased park-and-ride lots in the vicinity of the Shilshole landing site.

Shilshole Marina is isolated from most of Ballard's population, businesses, and services, with constrained access by any mode of travel. At 1.7 miles from central Ballard (NW Market Street and Ballard Avenue NW), walking would take about 35 minutes and biking about 9 minutes. Shilshole Marina's land access is along a single north-south linear roadway, Seaview Avenue NW, running parallel to the shoreline. Seaview Avenue NW has continuous sidewalks and a section of the separated and paved Burke Gilman Trail directly from central Ballard and east.

Parallel to the east side of Seaview Avenue NW are railroad tracks owned by BNSF Railway. The tracks are fully fenced and can be crossed only at very limited locations. On the other side of the tracks is a very steep hillside below neighborhoods that consist of single-family homes. These residential areas are accessible by way of very few streets, trails, and stairways. Thus, access from the neighborhoods uphill to the east is extremely limited and only for people with strong mobility. For those who would walk the trails or stairs, the travel time is at least 30 minutes or longer. The trails have no lights.

The Pier 50 landing site is adjacent to robust multimodal and transit connections throughout downtown Seattle.

Potential changes to connect to water taxi

Fixed Route Changes

There is no current or planned fixed-route transit service on or near Seaview Ave NW. However, as with the West Seattle water taxi landing site, which is not proximate to all-day transit service, a fixed route water taxi shuttle would be planned to create a connection for riders.

The potential fixed route shuttle would connect riders from Golden Gardens Park to NW Market St, shown in Figure 7. This shuttle would also create transfer opportunities to routes 15, 17, 18, 1010, 1012, 1993, and RapidRide D Line in the Metro Connects interim network. The shuttle would operate approximately every 30 minutes, matching the seasonal schedule of the water taxi. The creation of this route would need to be approved by the Council by ordinance. Additional costs are shown in Table 8.

Figure 7. Metro Connects interim network and potential shuttle service to the Shilshole landing site

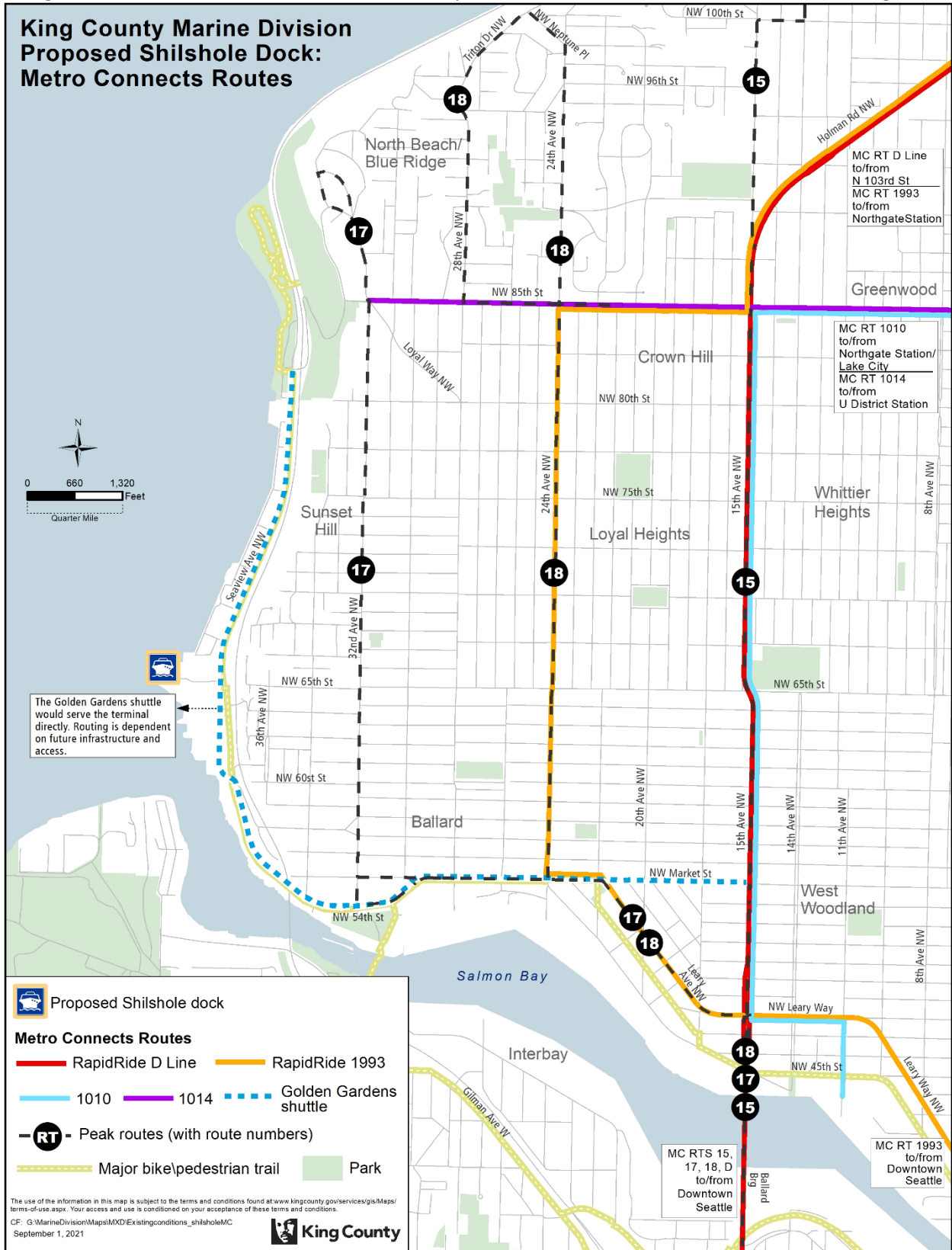

Table 8. Resources to support a potential Ballard water taxi shuttle

Route	Connections	Frequency	Resources Needed	
		To Water Taxi	Annual Hours	2021 Dollars*
Golden Gardens Shuttle	Golden Gardens - Shilshole Landing Site - Market Street	30 minutes	5,834	\$755,808 to \$1,102,470

*Based on 2021 Budget Costs for comparable services. Operating costs vary depending on service operator.

The cost estimates shown in Table 8 do not include additional operating costs for potential turnaround loops or capital costs relating to securing layover and comfort station access or vehicle procurement costs. These will be further assessed and included in the costing analysis.

Multimodal Changes

The completion of the Burke Gilman Trail, known as the “Missing Link,” is the main planned improvement to bike, walk, and roll access in the area. However, this project has an unclear completion date. Opportunities for alternative improvements would be limited due to the location and topography of the area. Any other improvements would require consultation with the City of Seattle, as the area around the landing site is not identified as an equity priority area for future Metro investments.

C. Equipment Specification

This section details methodology, assumptions, and preliminary work for the propulsion analysis and equipment specifications for the expansion routes as requested in the proviso. Equipment specification is a foundational assumption for moving forward with service understanding, landing site layouts, and costing of landing site and vessel capital and operating elements.

Methodology & Assumptions

Vessel General Specifications

To meet the service frequency proposed above, the vessels selected for the service were assumed to have a cruising speed of 28 knots. Vessel size was assumed to be a maximum passenger load of 150 passengers to meet estimated ridership demand and fall within the manning and other regulatory United States Coast Guard (USCG) requirements of a subchapter T vessel. Each potential vessel assumes an operating crew of three personnel, including one captain and two deck hands.

Vessel Emission Profile and Associated Propulsion Systems

Metro’s sustainability goals involve decreasing greenhouse gases now and into the future, and the propulsion alternative(s) selected for the Kenmore and Ballard routes should support these goals as much as possible. To be consistent with Metro’s emissions reductions goals, the selection of new vessel propulsion technology that will be modeled and costed in the final report have been selected based on the ability to meet and balance the following goals:

- Decrease greenhouse gas emissions
- Capitalize on current and future marine industry technological developments
- Reduce and balance the level of risk/ uncertainty in design cost and schedule of newly emerging technologies

A variety of propulsion alternatives were evaluated during the propulsion analysis with plug-in hybrid-electric using renewable diesel chosen to move forward into preliminary concept layouts and costing in the final report. The basis for this propulsion selection is outlined in the propulsion analysis below.

Terminal Power Storage

Terminal electrical power storage is needed when the power grid cannot support fast, high-power charging. The electrical power needs of the potential hybrid system would be minimal and the electrical power to serve the Kenmore and Ballard routes would require minimal physical space to support switch gear and capacitor banks. In the future, if the hybrid system is converted to a fully electric plug-in system, additional space at the terminal would likely be required to accommodate slower electrical power transfer from the electrical grid to storage on-site at the terminal. Equipment to support the plug-in hybrid electric system and potential additional equipment needed for full electrification has been outlined as part of the propulsion analysis and will be included in the preliminary terminal layouts and cost estimates to be included in the final report.

Propulsion Analysis

Overview

Before arriving at the plug-in hybrid propulsion system identified for further study, research, industry engagement, and analysis took place on a variety of options. The analysis involved consultation with industry stakeholders, including local passenger-only ferry vessel designers, marine battery manufacturers, and local utility companies, to gather information on the following key topics:

- Current available vessel and propulsion technologies and associated specifications
- Future technological landscape and timeframe of technological development
- Power requirements and landside infrastructure to support low-emissions propulsion

Please see Appendix A for a full list of stakeholders consulted in the propulsion analysis.

Multiple propulsion alternatives were evaluated specific to the two routes in review, each with different route profiles and power needs. Table 9 below shows all analyzed options, from zero-emissions to alternative diesel and gas fuels. For findings and more detail on the technologies behind each propulsion method, please see Appendix A.

Table 9. Alternative propulsion options assessed

Zero-Emissions	Hybrid Propulsion	Alternative Diesel & Gas Fuels
<ul style="list-style-type: none"> • Nuclear • Hydrogen Fuel Cell • Full Plug-in Electric 	<ul style="list-style-type: none"> • Hybrid Diesel-Electric • Plug-in Hybrid 	<ul style="list-style-type: none"> • Conventional Diesel (ultra-low sulfur diesel) • Biodiesel – B20 Blend • R99/ Renewable Diesel • Liquefied Natural Gas (LNG)

Of the analyzed alternatives, the plug-in hybrid option was deemed most promising to move forward to the costing analysis. For comparison purposes, a cost baseline will also be provided. This baseline will assume that the new Kenmore and Ballard services would be implemented with the propulsion technology that is currently used by the rest of the water taxi system, conventional diesel. The cost

baseline will be produced for comparative purposes only, with the plug-in hybrid being the propulsion method deemed most promising by the propulsion analysis. The following sections outline the process by which the plug-in hybrid alternative was selected, which included first identifying the needs a propulsion system must meet for each route and then discussing how the potential options meet the selection goals.

Needs and Considerations by Route

Taking the knowledge obtained through extensive outreach with industry stakeholders, each route was examined individually to identify its power needs and any route-specific conditions. Both routes require a cruising speed of 28 knots to meet the potential service schedules and remain time-competitive with other modes. The selected propulsion system alternative would need to provide enough power to travel at this high-speed for a significant portion of each route which ranges from approximately 9 to 10.5 miles in distance.

Kenmore

The potential Kenmore route would require more power than the Ballard route with its longer length of 10.5 miles in one direction. The uplands of the Kenmore landing site would have ample space for terminal energy storage, such as battery banks, if any were required to support the chosen alternative. The UW WAC would have less space and would be more constrained. Table 10 shows power requirements for the Kenmore route.

Table 10. Power requirements for the Kenmore route

Power Need per Round Trip	Kenmore Uplands Space	UW Uplands Space	Time between Sailings
2,900 kW hr	Sufficient	Limited	40 min

Ballard

As a slightly shorter route of just over nine miles, the Ballard route would require less power overall than the Kenmore route, despite also traveling at the high speed of 28 knots for most of the route length. Though having the same dwell time, or time a vessel spends at the dock between sailings, as the Kenmore route, the Ballard route would have 20 minutes longer between sailings. Both the Shilshole and Pier 50 landing sites would have sufficient space for shoreside infrastructure.

Additionally, with one end of this route landing at Pier 50, adjacent to the planned WSF Colman Dock electrification project, there is opportunity for the Ballard route to partner with other proposed projects along the downtown Seattle waterfront to more efficiently support improvements to the local power supply. However, it is important to note that transitioning the entire water taxi system, including the existing water taxi routes to zero emissions operations would result in additional power demands at the Pier 50 terminal. Table 11 shows power requirements for the Ballard route.

Table 11. Power requirements for the Ballard route

Power Need per Round Trip	Shilshole Uplands Space	Pier 50 Uplands Space	Time between Sailings
2,600 kW hr	Sufficient	Sufficient	60 min

Propulsion Alternative Evaluation

Each propulsion alternative was evaluated based on the identified goals for selection, which include:

- Decrease greenhouse gas emissions
- Potential to capitalize on future technological developments to further decrease emissions
- Level of risk/ uncertainty in design cost and schedule

Zero emission propulsion options (nuclear, hydrogen fuel, cell and full plug-in electric) would have the highest emissions reduction opportunity and the highest level of uncertainty as it relates to the timeframe, cost, and availability of fuel sources. This is mostly associated with the current state of power density, or the size and weight at which power can be stored on a vessel and the power produced from these alternatives. Alternative diesel and other gas fuels, such as biodiesel, R99, and LNG, provide low implementation risk, however they also offer the least amount of emission reduction and limited options to retrofit to other new technologies, if available. Hybrid options could support the desired route profiles with the current state of technology and would have the flexibility to be converted to zero-emissions systems in the future. Table 12 below summarizes how each of the propulsion options align with the selection goals.

Table 12. Summary of propulsion option analysis

Propulsion Option	Emissions reduction potential	Potential to capitalize on future technologies	Level of risk/ uncertainty in design cost & schedule
Zero-Emissions	Highest	Uncertain	High
Hybrid: Plug-in Hybrid	Medium Plug-in hybrid has a higher potential to reduce emissions than diesel-electric based on the ability to reduce emissions through landside charging using clean electricity from the grid.	High Diesel components could be removed while electric motors could remain and be powered by emerging technologies, such as improved batteries or hydrogen fuel cells.	Medium Technology currently exists that meets the specified route profiles, though it is not widespread.
Alternative Diesel and Gas Fuels	Medium to Low	Limited	Low

Hybrid Option Selected for Operations and Capital Cost Modeling

Due to the rapid pace of technological development for both hydrogen fuel cells and marine electric batteries, achieving zero-emissions operations by 2030 seems to be a feasible goal, provided that the selected propulsion alternative has a high potential to capitalize on future technological developments that would further decrease operational emissions. Hybrid options could support the desired route profiles with the current state of technology and would have the flexibility to be converted to zero-emissions systems in the future.

R99 is a specific form of renewable biodiesel that could be used to further decrease emissions when the system is not operating on electric power.

Hybrid propulsion systems also provide opportunities to reduce GHG emissions but would have a higher capacity to capitalize on future technological developments. Being powered by a diesel motor rather than shoreside power like the plug-in hybrid, the hybrid diesel-electric propulsion has fewer opportunities to reduce emissions. The plug-in hybrid propulsion would be a better option for the potential water taxi routes based on the ability to reduce emissions through landside charging. Hybrid systems require fewer heavy batteries and could support the potential route profiles.

Of the two hybrid options, the plug-in hybrid propulsion option reduces more GHG emissions and allows for easier future conversion to zero emissions technologies, therefore, the plug-in hybrid has been selected for the cost analysis in the final report. Table 13 includes a comparison of the hybrid options.

Table 13. Comparison of hybrid options

Type	Description	Strengths	Weaknesses
Hybrid Diesel-Electric	<p>Vessel is propelled by electric motors that are powered by diesel generators. On-board battery banks are used for power storage.</p> <p>Battery power is generally used during low-speed operations when power requirements are low.</p>	<p>Higher capital cost than traditional diesel but less than full battery electric</p> <p>Reduced emissions and noise when operating near terminals and in low-wake zones</p> <p>No shore power is needed.</p> <p>Can be converted to zero-emissions technologies developed in the future</p>	<p>Minimal emissions reduction as the batteries are charged by onboard diesel generators</p> <p>Added weight of the batteries and other electrical components increase the vessel weight, thereby increasing the power and fuel required to maintain speed unless other weight saving measures are implemented</p> <p>Batteries (with current technology) require replacement every 5 to 10 years</p>
Plug-in Hybrid [selected option]	<p>Vessel can be propelled with one of two operating models: diesel or electric. On-board battery banks are used for power storage and power an electric motor for propulsion. Batteries are charged by a landside power source. A diesel engine is also provided, and the vessel switches between power systems based on route operating needs</p>	<p>Reduced emissions</p> <p>Redundant systems</p> <p>Higher capital cost than conventional diesel but less than full battery electric</p> <p>Limited shore power infrastructure required</p> <p>Weight of additional propulsion system components could be offset using a carbon fiber hull to improve operating efficiency</p> <p>Easier to convert to zero-emissions technologies developed in the future</p>	<p>Added weight of the batteries and other electrical components increase the vessel weight, thereby increasing the power and fuel required to maintain speed unless other weight saving measures are implemented</p> <p>Batteries (with current technology) require replacement every 5 to 10 years</p>

Although the added weight of batteries and other components would initially limit the net impact on GHG emissions for a plug-in hybrid, the propulsion system could be designed to facilitate the replacement of the diesel engine and fuel tanks with either a high-power electric or fuel cell propulsion system when one of those technologies is sufficiently mature to be practical and efficient.

Propulsion Options Analyzed and Dismissed

Though propulsion options besides hybrid had promising features, they were ultimately not selected. The following sections discuss the dismissed options in more detail and provide key reasons for why they were dismissed from further consideration at this time.

Zero Emissions Options

The propulsion analysis first focused on the zero-emissions options of nuclear power, hydrogen fuel cell, and full plug-in battery electric and on the ability of these options to meet the desired service profile and route conditions. Table 14 summarizes the findings of this analysis, and additional detail is provided in the following pages.

Table 14. Zero-emissions propulsion analysis summary

Propulsion Option Analyzed	Emissions reduction potential	Potential to capitalize on future technologies	Level of risk/ uncertainty in design cost & schedule
Zero-Emissions Nuclear Hydrogen Fuel Cell Full Plug-in Electric	Highest Zero-emissions operations could be achieved once technology is mature enough to be practical and efficient.	Uncertain These technologies are the ones experiencing future development. Convertibility between technologies is currently unknown.	High Risk No technology currently exists that meets the specified route profiles. Nuclear has the highest risk and is not a prime focus of current technological development in the industry.

Nuclear-powered propulsion was eliminated early in the analysis due to its high safety requirements, production of radioactive waste, and the lack of interest and investment in nuclear power observed in the ferry industry. Hydrogen fuel cell and full plug-in electric were next evaluated. Numerous industry stakeholders have expressed interest in these emerging technologies, and their potential to bring zero-emission impacts to ferry operations is highly desirable. However, when applied to the Kenmore and Ballard route conditions specifically, the following challenges were observed:

1. Currently available zero-emissions technologies would not provide enough power to meet the needed route schedule and profile without making the vessel too heavy.
2. Developing cutting-edge technologies to meet the Kenmore and Ballard route profiles has a high level of uncertainty in the cost and schedule of the vessel design.

Given these high energy and power requirements on both routes, a zero-emissions vessel design using current battery and or fuel cell technology would be significantly heavier than using a traditional diesel propulsion system. To ensure that the vessel is not too heavy to operate could require alternating the routes' cruising speed and passenger capacity to decrease the amount of power needed to run the vessel. Changing the potential service speed and capacity would make both routes less desirable for users and/or less time competitive with current travel options, leading to low route ridership.

To avoid undesirable changes to the Kenmore and Ballard route profiles, updates to battery and fuel cell technology and/or emerging hull technologies (such as foil assisted or carbon fiber hulls) could be

pursued to make the vessel lighter while still providing sufficient power. However, investing in technology that is currently unavailable and/or not approved by the USCG would create risks to the schedules and costs of implementing the routes. As a result, choosing one of these zero-emissions options with the intent of developing experimental propulsion or associated vessel technology as a part of route implementation would introduce high risk to cost and schedule. Uncertainties include:

- Timeframe of vessel design
- Timeframe of and level of technological testing
- Cost of design effort
- Cost of manufacturing
- Length of USCG negotiations and regulatory approvals

Based on the challenges and risks outlined above, a zero-emissions propulsion option was not deemed the most feasible option for implementing the Kenmore and Ballard routes at this time.

Alternative Diesel and Gas Fuels

Of the remaining options, biodiesel, R99 renewable diesel, and LNG are alternative liquid fuels that could significantly reduce GHG emissions in comparison to traditional diesel. However, these options would have challenges in converting to future zero-emissions technologies because both rely on a liquid fuel powered engine. These types of engines cannot be powered by hydrogen fuel cell power or electric battery power and converting to zero-emissions technology in the future would require completely replacing the engine and the entire propulsion system. Table 15 summarizes alternative diesel and gas fuel options analyzed.

Table 15. Alternative diesel and gas fuels propulsion analysis summary

	Emissions reduction potential	Potential to capitalize on future technologies	Level of risk/ uncertainty in design cost & schedule
Alternative Diesel & Gas Fuels Conventional Diesel (ultra-low sulfur diesel) Biodiesel – B20 Blend R99/ Renewable Diesel Liquefied Natural Gas (LNG)	Medium to Low R99 renewable diesel, biodiesel, and LNG can decrease emissions but will never be able to achieve zero emissions. Conventional diesel produces the most emissions of all evaluated options.	Low Engine systems would need complete replacement to convert to hydrogen fuel cell or full electric.	Low Risk Existing engine systems currently make use of these types of fuels, and many proofs of concepts are available. Of the options, R99 is the most experimental with higher uncertainty in supply chain and cost.

Recommended Plug-in Hybrid System

The propulsion configuration most appropriate to move forward for costing and operations analysis as part of this technical work on implementation of the Kenmore and/or Ballard routes is a plug-in diesel electric hybrid. With this configuration, the ferry would operate on battery power during all low-speed segments of the route profile: approaching and departing the terminal, embarking and disembarking

passengers, and transiting through any low-wake or low-speed zones, such a west of Webster Point on Lake Washington, where the speed limit is seven knots. Figure 8 illustrates the components of a plug-in diesel-electric hybrid vessel in a 150-passenger catamaran vessel and how the system connects to the electrical grid.

Figure 8. Plug-In diesel-electric hybrid propulsion system and its connection to the grid

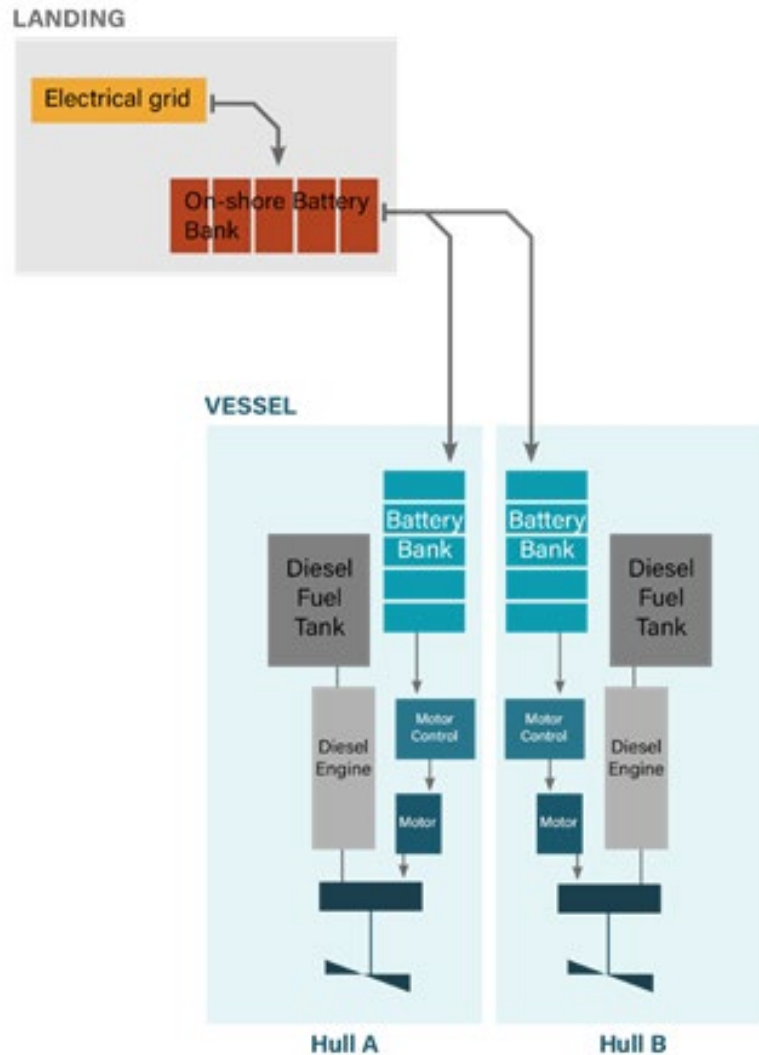

This option was selected for its ability to upgrade to the newest clean propulsion technology as batteries and/or fuel cell technology continue to advance. Though shorter and slower routes could operate with currently available technologies, the route lengths and speeds result in weights of the batteries and/or fuel cells that are currently infeasible for the potential Ballard and Kenmore routes. With the rapid pace of technological development, it is a goal that the hybrid system would be convertible to zero emissions operations within the next ten years. Please see Appendix A for figures that show how the initial hybrid system could be converted to either full plug-in electric or fuel cell propulsion while keeping the existing hull, low-speed electric motor, reduction gear, shafting, and propeller.

Until the time of system conversion, to decrease emissions as much as possible with the potential hybrid system, it is recommended that the diesel engine run on the lowest emission diesel option currently available, R99. Costing will include the higher cost of this diesel option as opposed to conventional diesel. Emissions savings will be estimated as operational profiles are further defined and will be provided in the final report.

Shoreside Infrastructure to Support a Plug-in Hybrid System

The selected plug-in hybrid would only operate on diesel power for the high-speed portion of the route and would use electric power for the low-speed zone east of Webster's Point and during all maneuvering to and from each landing. As a result, less electrical power would be needed at the terminal to charge the ferry batteries than if the system were full plug-in electric. The terminal electrical power demands to charge the batteries in this option would be small enough that chargers could be provided at both ends of the route with minimal local infrastructure improvements. Though minimal, this infrastructure would still take up terminal space and would include the following components:

- Capacitor Storage bank
- Switchgear
 - o Primary circuit breaker
 - o Utility meter
 - o Service transformer
 - o Main circuit breaker
 - o Auxiliary panel
 - o Distribution / energy storage system (ESS) panel

The shoreside infrastructure also requires an upland area to support these elements. The equipment would require an area of approximately 85 feet by 39 feet.

However, in the future when converting the hybrid system to an all-electric zero-emissions system additional space could be required as additional battery storage would likely be needed. Estimates for the current additional space, given existing battery energy density, are provided in Appendix A. Additional grid capacity may also be needed to support a full electric system which would require additional coordination with local utilities and could take up to five years depending on projects going on at the time and on the additional capacity needed.

If in future, a hydrogen fuel cell system was selected instead, terminal infrastructure needs would be different and could vary depending on the source of the hydrogen. If hydrogen is trucked in, the terminals would need to be reconfigured in a way that allows truck access to the dock, if such access is not currently available. If hydrogen is instead produced on-site, an electrolyzer and associated infrastructure would be needed. Additional details on terminal infrastructure needs would need to be developed at the time of system conversion.

D. Preliminary Capital and Operating Budgets

This preliminary report does not include any costing or budgetary values. The assumptions and technical analysis detailed in this preliminary report, as well as future technical work, will be used as the basis in all costing analysis. The final report to the Council will include detailed analysis and reporting on capital

as well as operations and maintenance costs. The final report will also detail budget assumptions for potential funding schemes for the expansion routes.

Costs and budgetary needs addressed in previous studies will be reviewed as part of the costing analysis for the final report. Capital and operational costs will differ from previous study findings. Key areas already identified in this preliminary report that will impact costs relative to previous studies include:

- The service levels for both routes have been updated to align with King County policy to provide additional service relative to previous study assumptions
- This study assumes two vessels instead of one for the Kenmore route
- Shoreside infrastructure costs will differ to accommodate the plug-in hybrid propulsion technology
- Plug-in Hybrid propulsion technology will have differing operational costs.

Additional details on preliminary costing assumptions are below.

Capital Assumptions

Grant funding was assumed to be a desirable option to support needed capital investments. As many federal grant programs require the National Environmental Policy Act (NEPA) process, implementation timelines will assume a formal NEPA process. Capital cost estimates will be informed by past and current Seattle marine waterfront work.

Operating Assumptions

The Ballard route was assumed to operate service with one vessel, while Kenmore assumes simultaneous operation of two vessels to support service. Both routes assume the presence of an additional vessel to serve as a back-up in case of unplanned maintenance, etc.

Both services assume that 45 minutes of crew costs would be needed both before and after planned vessel operating hours to allow for startup and tie-up time before and after passenger service. Terminal staff hours would be assumed for operations at the Lakepointe facility for the Kenmore route, while existing Pier 50 terminal personnel hours would be assumed sufficient to cover the Ballard route personnel needs.

Three crew members would be assumed necessary to operate each vessel. These members include one captain and two deckhands. An additional staff member (Port Captain) would be assumed for the Ballard route. Regarding maintenance personnel, three full-time dedicated maintenance personnel/employees (one engineer and two oilers) would be assumed for the Kenmore routes. The Ballard route would be assumed to have only two full-time dedicated maintenance personnel (one engineer and one oiler) as existing Pier 48 maintenance staff could also help support the route.

E. Additional Considerations to Prepare for Implementation of the Routes

In addition to the key areas addressed through earlier sections, additional considerations to prepare for implementation of the expansion routes will be detailed further in the final report. This may include more detailed information on water taxi system integration and prioritization, additional environmental considerations, funding scenarios, or specific details in response to comments on the preliminary report.

Stakeholder Engagement

The 2020 proviso work, as well as the 2015 expansion study and 2020 PSRC study, included stakeholder engagement activities. This included coordinating technical aspects and priorities with landing site property owners and local government agencies, as well as community surveys that showed support for these expansion routes and the potential landing sites. The technical work and recommendations included in the previous studies were guided by those efforts. The current proviso work will require engaging with landing site property owners and partner agencies to advance technical understanding for implementation including the Port of Seattle, the City of Seattle, the City of Kenmore, the University of Washington, and the Lakepointe development site owner. Additionally, technical coordination around shoreside, propulsion, and vessel technology needs for implementation will require engagement with utility providers and other specialized vendors. Further community engagement in addition to more robust stakeholder engagement with area agencies, tribes, and community groups would be conducted as a part of actual route implementation. Engagement with partners in previous planning efforts showed support for the routing and landing site locations for water taxi expansion from the Port of Seattle and City of Kenmore, however the UW does not support service to and from the UW WAC at this time. In advance of finalizing the technical analysis, the County will work with project partners to ensure the analysis and findings properly represent their priorities.

VI. Conclusion/Next Steps

This report provides preliminary analysis of planning and implementation of Kenmore and Ballard expansion water taxi routes. Key technical components detailed in this report include assumptions around route planning and service profile and delivery (including alternative propulsion) that are guiding the ongoing technical work. The final report body of work will further detail costs associated with capital improvements and operating elements needed to support the service levels outlined. Additional stakeholder engagement through the next phases of work will better inform preliminary design assumptions, associated costs, and additional implementation tasks. Metro, working with the Executive and the Council, will advance technical understanding and work with partners in preparing implementation readiness through this ongoing work. As detailed throughout this report, additional technical analysis and coordination with the Council and King County's partners is ongoing and will provide more robust findings in the Final Water Taxi Expansion Report, which will be transmitted to the Council as directed in the proviso prior to June 30, 2022.

VII. Appendices

Appendix A: Propulsion Analysis and Electrification

Preliminary Water Taxi Expansion Progress Report

appendix

Propulsion Analysis and Electrification

Propulsion Analysis Introduction and Methodology

To reduce the effects of climate change, ferry services and the transportation industry have been innovating technologically and working toward zero-emissions operations. Traditional passenger-only ferry (POF) vessels are powered by conventional diesel propulsion, or in the case of the current King County Water Taxi vessels, use of a B20 blend of biodiesel and ultra-low sulfur diesel fuel. Diesel fuel releases carbon dioxide, a greenhouse gas that contributes to climate change. At the state and local level there is a focus on establishing goals to decrease greenhouse gas emissions and aligning with these goals is a priority for implementing new King County Water Taxi service.

This alternative propulsion analysis was conducted to understand the propulsion alternatives available, how those alternatives apply to the proposed expansion routes (Kenmore and Ballard), and what level of emission savings could be achieved with the goal of achieving zero-emissions, as much as possible. Consultation with industry leaders provided information to help frame the applicability, timeframe of technology progression, and input as to the power required to meet the service profiles for the Kenmore and Ballard routes. Key industry stakeholders included local vessel designers, vessel builders, marine battery manufacturers, and local utility companies. Consultation with these stakeholders were around the following key topics:

- Current available vessel and propulsion technologies, and associated specifications
- Future technological landscape and timeframe of technological development
- Power requirements and landside infrastructure to support low-emissions propulsion

The following sections of this analysis present the background information and current conditions of POF propulsion technology, a summary of propulsion alternatives considered, the strengths and weaknesses when applying to Water Taxi service, and identification of the preferred propulsion system to be analyzed in the final report.

Industry Stakeholders
ABB
All American Marine
Arcadia Alliance
BAE Systems
BMT
Elliott Bay Design Group
Glosten
Green City Ferries
Schneider Electric
Seattle City Light
Spear Power Systems

Analysis Overview

Multiple propulsion alternatives were evaluated specific to the two routes in review, each with different route profiles and power needs. Table A1 below shows all analyzed options, from zero-emissions to alternative diesel and gas fuels. For findings regarding each of the analyzed options, please see the *Propulsion Alternatives and Vessel Design* section of this Appendix.

Table A1: Alternative Propulsion Options Assessed

Zero-Emissions	Hybrid Propulsion	Alternative Diesel & Gas Fuels
<ul style="list-style-type: none"> • Nuclear • Hydrogen Fuel Cell • Full Plug-in Electric 	<ul style="list-style-type: none"> • Hybrid Diesel-Electric • Plug-in Hybrid 	<ul style="list-style-type: none"> • Conventional Diesel (ultra-low sulfur diesel) • R99/ Renewable Diesel • Liquefied Natural Gas (LNG)

Of the analyzed alternatives, the plug-in hybrid option was recommended to move forward to the costing analysis. For comparison purposes, a cost baseline will be also provided. This baseline will assume that the new Kenmore and Ballard services will be implemented with the propulsion technology

that is currently used by the rest of the water taxi system, conventional diesel. The cost baseline will be produced for comparative purposes only, with the plug-in hybrid being the propulsion method deemed most promising by the propulsion analysis. The following sections outline how this alternative was selected by first identifying the needs a propulsion system must meet for each route and then discussing how the potential options meet the selection goals.

Background and Current Conditions

Passenger vessels operating at high speeds (>25 knots) have high energy requirements and the regulatory framework for these alternative propulsion options is not yet clearly defined. The following section provides background on the energy needed to power the proposed water taxi services and an overview of the current regulatory and technological conditions in which the proposed POF routes would operate.

Energy and power needs for high-speed ferries

POF services with smaller vessels that run at high speeds require a large amount of power to operate with a smaller space to accommodate battery storage. Given current technologies, these characteristics are currently challenging to decrease emissions while maintaining higher vessel speeds. The vessel hull resistance of high-speed ferries increases exponentially with the vessel speed. In other words, a ferry operating at 28 knots (the speed proposed for both the Kenmore and Ballard route to meet time competitiveness of other modes) needs between four and eight times as much power as a similar ferry operating at half that speed.

Providing this much power from alternative energy sources can prove difficult as current electric battery and other low emissions technologies have a lower energy density than diesel fuel. In the case of batteries, this means that the number and size of batteries required to store enough energy to operate the vessel at the required speed (energy density), would be too heavy to fit in a standard hull design for a 150-passenger vessel and would require even more energy to push the heavier vessel through the water. Significant hull design changes could mitigate this. These changes may include making the hull larger while carrying fewer passengers, though this mitigation measure would likely be insufficient and would still result in a negative impact of the service profile currently established for these routes. Another option would be to use advanced hull materials, such as carbon fiber, to reduce the weight of the hull. These advanced materials may reduce the hull weight enough to maintain the current service profile but will likely require arduous regulatory approvals with uncertain timelines. This is discussed more in more detail in the *Regulatory environment* subsection later in this report. Until the energy density of current battery technology improves, full electrification of a high-speed, smaller vessel may be unattainable.

An alternative energy form, compressed hydrogen, used in fuel cells has an energy density that is higher than current battery technology but still lower than diesel fuel. The hydrogen is stored in a compressed gas form and current regulations would require the storage tanks be located outside the hull for safety.

Like other transit modes, high-speed POF services aim to move people as quickly as possible with just enough time in the dock to unload and load passengers (referred to as dwell time). This ferry service model does not allow for long periods of time at the dock for charging batteries.

Current state of battery technology

With the increasing demand for battery powered automobiles and buses, battery technologies for these land-based modes of transport have been developing in parallel with batteries for marine vessels. While lessons can be learned across platforms, the battery technologies themselves are very different and are

not directly interchangeable. For example, marine batteries are under the jurisdiction of the US Coast Guard (USCG) and must meet a higher level of safety requirements. These safety requirements, particularly related to preventing and suppressing fires if the batteries overheat, can cause marine batteries to be more expensive than their landside counterparts. Marine battery systems can also charge more quickly and supply more power per battery than the batteries currently used in the automobile industry.

Marine battery technology is rapidly developing, but the weight of batteries significantly increases energy consumption. Additionally, current batteries can be limited in how fast they can be charged or discharged. A major focus of marine battery innovation is the development of alternative chemistries that have a greater energy density, allowing future battery banks the ability to store the same amount of energy with less weight. Another focus for marine battery development is the ability to charge and discharge quickly without affecting the service life of the batteries.

Given the larger energy requirements for high-speed ferry routes and the short dwell times available for charging, transferring sufficient energy into the vessel batteries creates a very high demand for a relatively short period of time. In many locations, these high, short-term demands cannot be met if the ferry were to be charged directly from the electrical grid. To mitigate this, shoreside batteries can be used to reduce the peak demand on the grid, but the short discharge time is likely to shorten the expected service life for the batteries.

Regulatory environment

Low-emissions ferry technology is a rapidly evolving industry. USCG regulations for electric propulsion technology and hydrogen storage and transfer are in development. As a result, regulations do not currently exist for many technologies, and would require coordination with the USCG through the planning, design, and construction phases of the project. Vessel design alternatives that include lighter materials (such as carbon fiber) and reduce fuel consumption are also under development by the USCG.

Other federal regulations faced by ferry propulsion systems that use diesel engines include all new and re-powered engines being required to meet the EPA's Tier 4 engine standards. Tier 4 engines are accompanied by exhaust treatment systems that result in lower emissions of dangerous air pollutants such as nitrous oxides, sulfur oxides, and particulates. However, Tier 4 engine regulations are not specifically aimed at reducing the greenhouse gas emissions that contribute to climate change. Apart from Tier 4 engine systems, leaner low-sulfur diesel and biodiesel blends are also used by many services to decrease smog and particulates caused by combustion engines that are used in POF operations.

Propulsion Alternatives and Vessel Design

There are a variety of vessel propulsion system options and vessel hull designs that can reduce greenhouse gas emissions. The following sections summarize the vessel propulsion options and vessel design options considered for the potential Kenmore and Ballard Water Taxi routes.

Alternative diesel and gas fuels

Low-emission and renewable fuels are available that can be used with traditional diesel (compression ignition) engines. While these fuels do not necessarily reduce greenhouse gas emissions, they are currently used to reduce the emission of particulates and other air pollutants compared to conventional diesel fuel. A B20 blend ultra-low sulfur bio-diesel fuels are used in the current King County Water Taxi vessels. These alternatives are drop in fuels, do not require any additional shoreside infrastructure, and can be used with existing engines. However, some alternatives, like liquefied natural gas (LNG), require different engines, modifications to an engine's fuel system, and could affect maintenance schedules.

While conventional diesel fuel is currently the least expensive option, it has the highest greenhouse gas emissions. Of the fuel options, R99/Renewable Diesel best meets Metro’s emissions goals by providing the greatest reduction in greenhouse gases. Table A2 provides a summary of the strengths and weaknesses of the alternative diesel and gas fuel options.

Table A2: Strengths and Weaknesses of Alternative Diesel and Gas Fuels

Type	Description	Strengths	Weaknesses
Conventional Diesel (B20 ultra-low sulfur bio-diesel)	Use Tier 4 engines and conventional liquid diesel fuel	<ul style="list-style-type: none"> • Least expensive • Same as existing service • No shoreside infrastructure required; delivered by truck or at commercial fuel pier 	<ul style="list-style-type: none"> • Highest emissions • Subject to fluctuating diesel prices • Future retrofits/technological updates would likely be expensive
R99/ Renewable Diesel¹	Use Tier 4 engines and renewable diesel	<ul style="list-style-type: none"> • Significant emissions reduction (60 to 90% cleaner than conventional diesel¹) • Petroleum free • Familiar technological platform • Minimal shoreside infrastructure- possibility of fueling by truck 	<ul style="list-style-type: none"> • More expensive than conventional diesel • Non-zero emissions • Limited maritime experience with R99 - additional maintenance and replacement of filters may be required • Future retrofits/technological updates would likely be expensive
Liquefied Natural Gas (LNG)	Natural gas is held in a liquid state using a cryogenic tank and is used to fuel an engine that is designed to accommodate LNG.	<ul style="list-style-type: none"> • Decrease in emissions when compared to non-biodiesel options • Multiple current examples in operations • Potential operations and maintenance cost savings due to LNG being cleaner than diesel • Minimal shoreside infrastructure- possibility of fueling by truck 	<ul style="list-style-type: none"> • Diesel engines require modifications to use LNG • Current operations use LNG engines for significantly larger vessels • Non-zero emissions in burning • Emissions are often released during extraction and storage • Fuel must be stored at sub-zero temperatures • Limited opportunity to convert systems and capitalize on emerging technologies • Infrastructure has higher capital costs than diesel • Gas tanks would need to be located above deck due to USCG regulations

Hybrid propulsion options

Hybrid propulsion options strive to maintain the reliability of diesel power while providing opportunities to decrease emissions and transition to more electric propulsion as battery technology continues to

¹ <https://frogferry.com/pilot/sustainability/>

improve. A variety of hybrid options are currently available and represent the mid-range for vessel costs--they are more expensive than conventional diesel options but less expensive than the zero-emission propulsion options discussed in the following section².

The hybrid propulsion options provide redundancy to be able to use both diesel and electric propulsion. The hybrid diesel-electric option is powered by a diesel motor rather than shoreside power like the plug-in hybrid, thus has fewer opportunities to reduce emissions. The plug-in hybrid propulsion is a better option for the Kenmore and Ballard potential water taxi routes based on the ability to reduce emissions through landside charging using clean electricity generated from hydropower. Table A3 provides a summary of the strengths and weaknesses of currently available hybrid propulsion options.

Table A3: Strengths and Weaknesses of Hybrid Propulsion Options

Type	Description	Strengths	Weaknesses
Hybrid Diesel-Electric	<p>Diesel generators are used to generate power for electrical propulsion motors. On-board battery banks are used for power storage.</p> <p>Battery power is generally used during low-speed operations when power requirements are low.</p>	<ul style="list-style-type: none"> • Higher capital cost than traditional diesel but less than full battery electric • Reduced emissions and noise when operating near terminals and in low-wake zones • Moderate transition to zero-emissions technologies developed in the future 	<ul style="list-style-type: none"> • Minimal emissions reduction as the batteries are charged by onboard diesel generators • Added weight of the batteries and other electrical components increase the vessel weight, thereby increasing the power and fuel required to maintain speed unless other weight saving measures are implemented • Batteries (with current technology) require replacement every 5 to 10 years
Plug-in Hybrid	<p>On-board battery banks are used for power storage and power an electric motor for propulsion. Batteries are charged by a landside power source. A diesel engine is also provided, and the vessel switches between power systems based</p>	<ul style="list-style-type: none"> • Reduced emissions • Redundant systems • Higher capital cost than conventional diesel but less than full battery electric • Limited shore power infrastructure required • Weight of additional propulsion system components could be offset using a carbon fiber hull to improve operating efficiency • Easy transition to zero-emissions technologies developed in the future 	<ul style="list-style-type: none"> • Emission reductions when operating on battery power which is slightly offset due to the weight of the systems • Added weight of the batteries and other electrical components increase the vessel weight, thereby increasing the power and fuel required to maintain speed unless other weight saving measures are implemented • Batteries (with current technology) require replacement every 5 to 10 years

² Lummi Island Ferry System Alternative Fuel Analysis

	on route operating needs		
--	-----------------------------	--	--

Zero-emissions options

Nuclear, hydrogen fuel cell, and full plug-in electric vessels are on the cutting edge of zero-emissions propulsion technology. Smaller high-speed POF vessels, such as those proposed for the Kenmore and Ballard routes, are an emerging frontier for zero emissions technology. Due to the very large power requirements for these routes, the challenges with energy density that are faced by hydrogen fuel cell propulsion options are similar to those faced by battery technology when attempting to maintain sufficiently fast service speeds while keeping operating costs relatively low.

While nuclear power has zero emissions, there are no ferry vessels that are powered by this technology. There are challenges with safety, the regulatory environment, and nuclear waste disposal.

Hydrogen fuel cells have a lot of potential as a marine power source and demonstration vessels have been built in the U.S. Currently, the size and weight of the fuel cell itself, the need to store hydrogen as a compressed gas, and the relatively low energy density of this fuel limits the applicability of this energy source for high-speed ferries. Another challenge is the availability of hydrogen fuel, which must be delivered by truck from California at this time, thereby offsetting any emission reductions resulting from its use³.

Each of these challenges is being addressed by emerging technologies, and during the preparation of this report, Washington Maritime Blue⁴ submitted a letter of interest in response to the US Department of Energy's Hydrogen Energy Earthshot program outlining the numerous regional initiatives and studies currently underway to develop a sustainable hydrogen-based maritime ecosystem including generators, distributors, end users, and supporting industries. The potential for hydrogen fuel cell ferry service operated by King County Metro was included in the letter. If adequate support can be found for these programs, hydrogen as a clean fuel could be a much more viable option in five to ten years.

Full plug-in electric vessels use battery technology to power the vessels. This technology, while currently employed in the maritime industry, is typically ideal for shorter, slower routes. Currently, the battery power required for full plug-in electric vessels weighs down the vessel that inhibits the necessary higher speeds.

Table A4 summarizes the strengths and weakness of the zero-emission propulsion options that could potentially be used for the proposed Kenmore and Ballard Water Taxi routes.

³ There is a project underway to build a hydrogen generation plant at the Wells Dam in Eastern Washington using excess hydropower. Once complete, hydrogen will be more readily available in the Puget Sound area.

⁴ Washington Maritime Blue is a non-profit, strategic alliance formed to accelerate innovation and sustainability in support of an inclusive blue economy.

Table A4: Strengths and Weaknesses of Zero-emissions Propulsion Options

Type	Description	Strengths	Weaknesses
Nuclear	Powered by nuclear fission	<ul style="list-style-type: none"> • Zero emissions 	<ul style="list-style-type: none"> • Higher safety requirements • No nuclear-powered ferry vessels are currently in operation • Nuclear waste disposal • Significant coordination with the USCG due to limited existing regulations
Hydrogen Fuel Cell	Batteries are used for startup and can be used alongside fuel cell power for faster speeds. Fuel cell-only power can be used. While travelling at slower speeds and idling at the dock, fuel cells can recharge the batteries.	<ul style="list-style-type: none"> • Zero emissions- provided that the hydrogen is produced w/o emissions as well • Alignment with the DOE's Hydrogen Energy Earthshot initiative • Better suited to the high speeds (and high-power requirements) of the routes in this study • Potential for technological upgrades and increased speed/capacity in the next 5 years • Fewer mechanical parts than a traditional diesel system could lead to decreasing maintenance costs • Minimal shore power infrastructure needed 	<ul style="list-style-type: none"> • Production of hydrogen offsite can be emissions generating • Refueling of current technology could take a couple of hours • Current closest hydrogen production is in California- significant emissions produced in transport of hydrogen fuel • No current vessels of this size and speed have been developed as proof of concept • Hydrogen tanks may need to be located above deck due to safety regulations • Significant coordination with the USCG due to limited existing regulations
Full Plug-in Electric	Electricity is drawn from the power grid or onshore battery reserves into onboard electrical battery storage. Batteries power an electrical propulsion motor.	<ul style="list-style-type: none"> • Zero emissions- provided that the electricity is also produced w/o emissions • Ideal for shorter/slower routes with lower power demand • Fewer mechanical parts than a traditional diesel system could lead to decreasing maintenance costs 	<ul style="list-style-type: none"> • Weight from batteries needed may necessitate an alternate hull form (foil-assisted hull form, carbon fiber composite hull) which is more expensive and carries a higher design risk • Limited dwell time requires landside battery infrastructure to reduce demand on the power grid • Batteries (with current technology) require replacement every 5 to 10 years • Extensive shore power infrastructure needed • Significant coordination with the USCG due to limited existing regulations

Vessel Design to Reduce Emissions

Vessel design elements like foil-assist hulls or carbon fiber hulls can be used to decrease the weight and energy needs of a vessel and thereby reduce emissions. However, these associated technologies are often expensive and few US shipyards currently have the ability to construct them.

These vessel design options can be used in conjunction with alternative propulsion options. Figure A1 shows how these technologies work with different propulsion options.

Example Vessel Design Options

Most Similar to Current Water Taxi

Traditional Diesel +
Light-weight Aluminum Hull

Most Experimental Technology Water Taxi Vessel Options

Plug-In Full Electric +
Foil Assisted Hull

Hydrogen Fuel Cell +
Foil Assisted Hull

Plug-In Full Electric +
Carbon Fiber Hull

Hydrogen Fuel Cell +
Carbon Fiber Hull

Foil-Borne and Foil-Assist Hulls

Energy demands can be reduced by developing hull forms with lower resistance. Hydrofoils that either fully or partially support the hull at cruising speed are currently in service, with partially supporting foils more common. Hydrofoils reduce resistance by lifting the hull out of the water, thereby reducing wave-making resistance. While this reduces resistance at medium to high speeds, the foil increases drag and vessel draft at low speeds. For deep water routes with no speed restrictions, such as Ballard to downtown Seattle, foils can work well. On the Kenmore to UW route, the slow zone west of Webster Point and the water depth at the UW WAC present challenges that would require additional study to determine the viability of a foil-supported hull.

Carbon Fiber or Composite Hull Structure

Light-weight hull options such as carbon fiber are being developed to improve the efficiency of conventionally powered ferries and they can also be used to mitigate the weight impacts of electric propulsion batteries and other currently weight-intensive propulsion alternatives.

These materials are strong but are less malleable than traditional metal hulls. While the breaking strength of carbon fiber may be higher than aluminum, if an unusual load is applied, such as hitting a mostly submerged log at high speed, carbon fiber would crack or break where aluminum would be bend or dent. This behavior drives the need for material-specific design formulas and safety factors for new USCG regulations currently under development to ensure a carbon fiber or composite hulls are at least as safe as those built from steel or aluminum.

Moreover, manufacturing carbon fiber hulls requires advanced technology and training available at only a few US boatbuilders. Consequently, pursuing a vessel with this technology may limit the location options for vessel construction and/or hull maintenance.

Propulsion Alternative for Costing: Plug-in Hybrid

Based on the reduction in greenhouse gas emissions, the available technology, and ability for future conversion to zero-emission propulsion, the plug-in hybrid propulsion option is recommended for future analysis for the potential Kenmore and Ballard water taxi routes. The following sections provide the goals established for evaluating propulsion alternatives, the route characteristics, and additional detail regarding plug-in hybrid vessel technology.

Propulsion Alternative Evaluation Goals

Each propulsion alternative was evaluated based on the identified goals for selection, which include:

- Decrease greenhouse gas emissions
- Be able to capitalize on future technological developments to further decrease emissions
- Avoid high levels of risk/ uncertainty in design cost & schedule

Evaluation of alternatives relative to these goals helped to identify the options most suitable for the proposed routes and aligned with overall King County Metro goals of reducing greenhouse gases of the overall Metro system.

Route considerations

Taking the identified goals and the knowledge obtained through extensive outreach with industry stakeholders, each route was examined individually to identify its power needs and any route-specific conditions. Both routes require a cruising speed of 28 knots to meet the proposed service schedules and remain time-competitive with other modes. The selected propulsion system alternative would need to provide enough power to travel at this high-speed for a significant portion of each route which ranges from approximately 9 to 10.5 miles in distance.

Kenmore

The proposed Kenmore Water Taxi route, which is approximately ten and a half miles long in one direction and requires a cruising speed of 28 knots to provide a competitive travel time, requires more power compared to other existing Water Taxi routes.

2,900 kW hr	Sufficient	Limited	40 min
Power Need per Round Trip	Kenmore Uplands Space	UW Uplands Space	Time Available to Charge Batteries b/w Sailings

Ballard

As a slightly shorter route of just over nine miles, the Ballard route would require less power overall than the Kenmore route, despite also traveling at the high speed of 28 knots for most of the route length. Additionally, as sailings on this route depart every hour, there is additional time to charge landside batteries, meaning that the overall grid demand would be lower for this route than for the Kenmore route. There is also more opportunity to charge shoreside electric batteries at both ends of the route due to the longer dwell time between sailings.

With one end of this route landing at Pier 50, adjacent to the planned WSF Colman Dock electrification project, there is opportunity for the Ballard route to partner with other proposed projects along the Seattle Waterfront to more efficiently support improvements to the local power supply. However, it is

important to note that transitioning the entire Water Taxi system, including the existing Water Taxi routes to zero emissions operations would result in additional power demands at the Pier 50 terminal.

2,600 kW hr	Sufficient	Sufficient	60 min
Power Need per Round Trip	Ballard Uplands Space	Pier 50 Uplands Space	Time Available to Charge Batteries b/w Sailings

Propulsion Alternative Evaluation

Taking into consideration the selection goals and the route characteristics, each propulsion alternative was then evaluated to identify the options most suitable for the proposed routes.

Zero emission propulsion options (nuclear, hydrogen fuel cell and full plug-in electric) were found to have the highest emissions reduction opportunity and also the highest level of uncertainty as it relates to the timeframe, cost, and availability of fuel sources. This is mostly associated with the current state of power density, or the size and weight at which power can be stored on a vessel and the power produced from these alternatives. Alternative diesel and other gas fuels such as hydrogen were identified to provide low implementation risk, however they also provide the least amount of emission reduction and would be more difficult to retrofit if new technology options become available. Hybrid options can support the desired route profiles with the current state of technology and have the flexibility to be converted to zero-emissions systems in the future. Table A5 below summarizes how each of the propulsion options align with the selection goals. The following sections provide additional detail on how the proposed propulsion options do and do not align with the identified goals.

Table A5: Summary of Propulsion Option Analysis

Propulsion Option	Emissions reduction potential	Potential to capitalize on future technologies	Level of risk/ uncertainty in design cost & schedule
Zero-Emissions	Highest	Uncertain	High Risk
Hybrid	Medium Plug-in hybrid has a higher potential to reduce emissions than diesel-electric based on the ability to reduce emissions through landside charging using clean electricity from the grid.	High Diesel components could be removed while electric motors could remain and be powered by emerging technologies, such as improved batteries or hydrogen fuel cells.	Medium Risk Technology currently exists that meets the specified route profiles, though it is not widespread.
Alternative Diesel and Gas Fuels	Medium to Low	Limited	Low

Decrease Greenhouse Gas Emissions

The first factor considered was how the propulsion alternative(s) selected for the Kenmore and Ballard route would align with Metro's goal to decrease greenhouse gases now and into the future. As a result, the zero-emissions propulsion options of hydrogen fuel cell and full plug-in electric would be the most desired if the systems were light enough to support POF service at the needed cruising speed for the desired vessel size of 150 passengers. However, interviews with industry stakeholders indicated that no

POF vessel of the desired size is currently operating with a zero-emissions propulsion system at a 28-knot speed for a route of this length.

Given the energy requirements and dwell times on both routes, full electrification with direct charging of the ferries from the grid is not feasible without significant upgrades to the available electrical utility infrastructure. Using shoreside batteries to limit the peak demand may be possible but only if one-way charging is provided at both ends of both routes. Even with one-way charging available at all landings, a full-electric propulsion system would weigh more than a comparable diesel propulsion system and either a carbon fiber or foil-supported hull would be required to mitigate the added weight. Additionally, space available at the terminal locations was evaluated to determine how much square footage could be devoted for electric battery onshore storage. While most terminals had sufficient space for the footprint for batteries to support a fully-electric service, space available at the UW WAC is currently limited to support the large footprint needed for batteries to support a fully-electric option for this route, given current battery energy density.

Level of risk/uncertainty in design cost & schedule

Although the zero-emissions vessel propulsion options would reduce emissions, pursuing a vessel design of zero emissions for the Kenmore and Ballard route profiles at this stage would have two primary risks.

1. A high likelihood of the vessel design requiring alteration to the routes' cruising speed and passenger capacity due to current technology weight limitations. Changing the proposed service speed and capacity would make both routes less desirable for users and/or less time competitive with current travel options, ultimately leading to low route ridership.
2. The uncertainty in the cost and schedule of the vessel design process due to the lack of currently available technology to meet the proposed route specifications. New technology could be developed as a part of this design process that may not require changes to the proposed service profiles, but it is uncertain how long these technologies would take to be developed, how much they would cost to design and manufacture, and how long they might take to be approved by USCG and other relevant regulatory agencies.

Potential to capitalize on future technological developments

Due to the risks outlined above, a zero-emissions propulsion option was not deemed the most feasible option for implementing the Kenmore and Ballard water taxi routes at this time. However, due to the rapid pace of technological development for both hydrogen fuel cells and marine electric batteries, achieving zero-emissions operations by 2030 seems to be a feasible goal, provided that the selected propulsion alternative has a high potential to capitalize on future technological developments that would further decrease operational emissions. Of the remaining propulsion alternatives, a hybrid propulsion system would provide the greatest potential for future emission reductions as it would include both a diesel engine and an electric motor. Provided it is designed with future upgrades in mind, the electric motor can be powered by electricity from hydrogen fuel cells or electric batteries charged from onshore power. The diesel engine and diesel storage tank can be then replaced with additional battery capacity and a more powerful electric motor or hydrogen storage and a more efficient fuel cell.

Plug-in Hybrid

Based on this analysis, a plug-in hybrid propulsion vessel would be the most viable for the proposed routes. The vessel would only operate on diesel power for the high-speed portion of the route and would use electric power for the low-speed zone east of Webster's Point (Kenmore/WAC route) and all maneuvering to and from each landing. The shoreside electrical demands to charge the batteries in this option would be small enough that chargers could be provided at both ends of the route with minimal local infrastructure improvements. Although the added weight of batteries and other components would initially limit the net impact on greenhouse gas emissions, the propulsion system could be

designed to facilitate the replacement of the diesel engine and fuel tanks with either a high-power electric or fuel cell propulsion system when one of those technologies is sufficiently mature to be practical and efficient.

Figure A2 illustrates the components of a plug-in diesel-electric hybrid vessel in a 150-passenger catamaran vessel and how the system connects to the electrical grid.

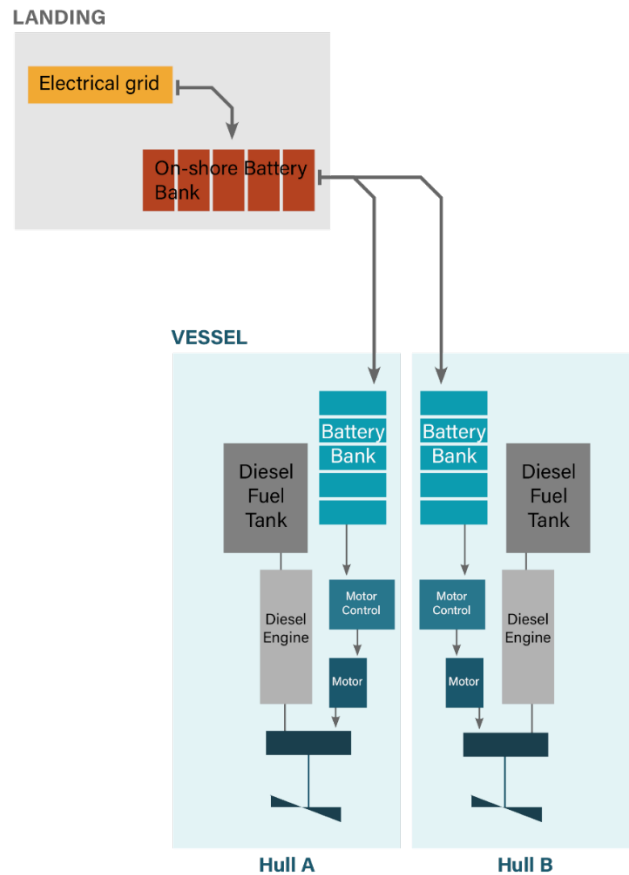

This option was selected for its ability to upgrade to the newest clean propulsion technology as batteries and/or fuel cell technology continue to advance. Though shorter and slower routes could operate with currently available technologies, the route lengths and speeds result in weights of the batteries and/or fuel cells that are currently infeasible for the proposed Ballard and Kenmore routes. With the rapid pace of technological development, this hybrid system could be converted to zero-emissions operations within the next ten years. Figure A3 shows how the initial hybrid system could be converted to either full plug-in electric or fuel cell propulsion while keeping the existing hull, low-speed electric motor, reduction gear, shafting, and propeller.

Initial Delivery Propulsion Configuration (one per hull)

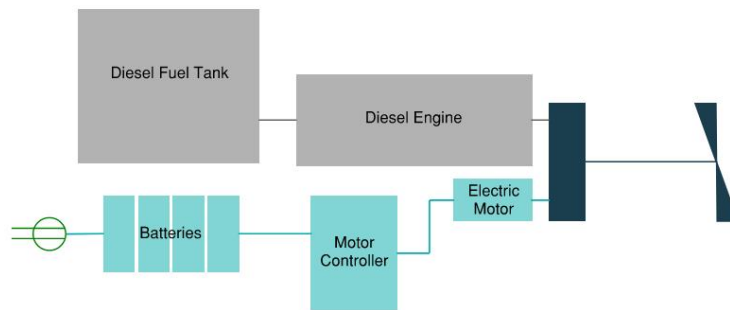

Future Propulsion Configuration - Battery Option (one per hull)

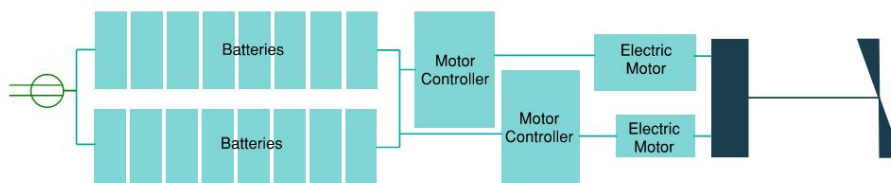

Future Propulsion Configuration - Fuel Cell Option (one per hull)



Figure A3- Proposed Hybrid Propulsion Configuration and Potential System Conversion Options

Until the time of system conversion, to decrease emissions as much as possible with the proposed hybrid system, it is recommended that the diesel engine run on R99 that is the lowest emission diesel option currently available. Costing will include the higher cost of this diesel option as opposed to conventional diesel. Emissions savings will be estimated as operational profiles are further defined and will be provided in the final report.

Shoreside infrastructure to support plug-in hybrid

To support a full plug-in electric or a hybrid plug-in electric service with round-trip charging on either route, shoreside electrical infrastructure is required. Compared to the high infrastructure needs of a fully-electric system, a plug-in hybrid requires less infrastructure and would have a much lower demand if charging directly from the grid. For the recommended plug-in hybrid option, the battery Energy Storage Systems (ESS) containers would not be required but a capacitor bank would likely be required to mitigate the upstream impacts of the short-term demand. Switchgear including a primary circuit breaker, utility meter, service transformer, main circuit breaker, auxiliary panel, and distribution / ESS panel would also be required.

The electrical equipment required for a future full plug-in electric service with round trip charging is more extensive and, with current technology, would include the following:

- Three containerized battery energy storage systems (ESS)
- Three ESS transformers

- Switchgear
 - Primary circuit breaker
 - Utility meter
 - Service transformer
 - Main circuit breaker
 - Auxiliary panel
 - Distribution / ESS panel

The shoreside infrastructure also requires an upland area to support these elements. The equipment would require an area of approximately 85 feet by 39 feet, as shown in Figure A4.

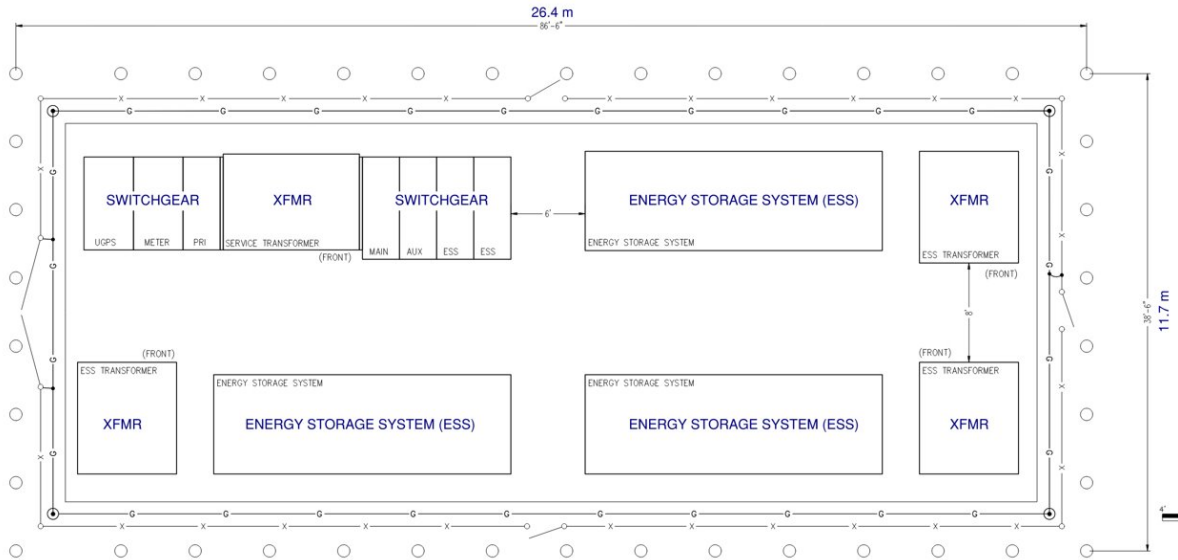

Figure A4: Electrical Equipment at Kenmore or Shilshole for Round-Trip Full-Electric Service

With lower energy requirements, the equipment for one-way charging of a full-electric ferry at these terminals would still require two battery ESS, transformers, and switchgear but it could be configured to occupy a small area of approximately 46 feet by 52 feet, as is shown in Figure A5.

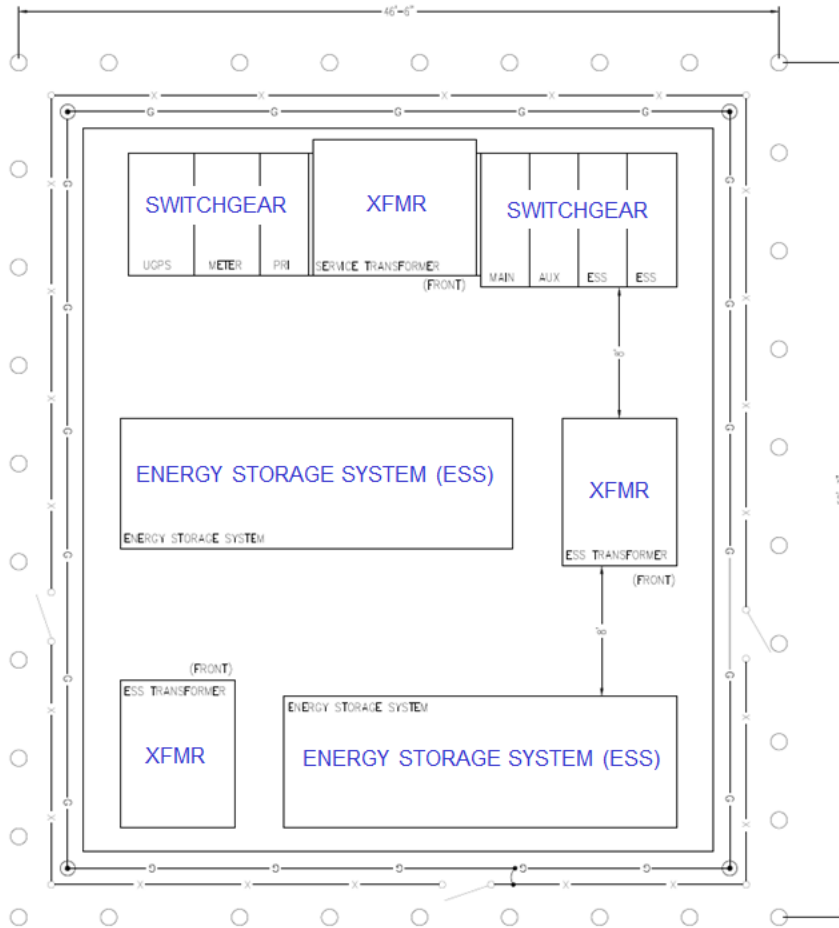

Figure A5: Electrical Equipment at Kenmore or Shilshole for One-Way Full-Electric Service

In future, when converting the hybrid system to an all-electric zero-emissions system, additional space requirements may differ depending upon advancements in battery technology. Based on coordination with the local utilities, additional grid capacity may also be needed to support a full electric system, which would require additional coordination and could take up to 5 years depending on projects going on at the time and on the additional capacity needed.

If in the future, a hydrogen fuel cell system was selected instead, terminal infrastructure needs would be different and could vary depending on the source of the hydrogen. If hydrogen is trucked in, the terminals will need to be reconfigured in a way that allows truck access to the dock, if such access is not currently available. If hydrogen is instead produced on-site, an electrolyzer and associated infrastructure would be needed. Additional details on terminal infrastructure needs would be developed at the time of system conversion.

Certificate Of Completion

Envelope Id: 566A90DDE88843CB8B8F16DCC0B1A14D	Status: Completed
Subject: Please DocuSign: Motion 16050.docx, Motion 16050 Attachment A.pdf	
Source Envelope:	
Document Pages: 2	Signatures: 2
Supplemental Document Pages: 57	Initials: 0
Certificate Pages: 2	Envelope Originator:
AutoNav: Enabled	Cherie Camp
Enveloped Stamping: Enabled	401 5th Ave
Time Zone: (UTC-08:00) Pacific Time (US & Canada)	Suite 100
	Seattle, WA 98104
	Cherie.Camp@kingcounty.gov
	IP Address: 198.49.222.20

Record Tracking

Status: Original	Holder: Cherie Camp	Location: DocuSign
3/2/2022 10:15:44 AM	Cherie.Camp@kingcounty.gov	
Security Appliance Status: Connected	Pool: FedRamp	
Storage Appliance Status: Connected	Pool: King County General (ITD)	Location: DocuSign

Signer Events

Claudia Balducci
 claudia.balducci@kingcounty.gov
 King County General (ITD)
 Security Level: Email, Account Authentication (None)

Signature

DocuSigned by:

 7E1C273CE9994B6...
 Signature Adoption: Pre-selected Style
 Using IP Address: 73.83.124.149

Timestamp

Sent: 3/2/2022 10:18:53 AM
 Viewed: 3/2/2022 10:46:01 AM
 Signed: 3/2/2022 10:46:15 AM

Electronic Record and Signature Disclosure:

Not Offered via DocuSign
 Supplemental Documents:

Motion 16050 Attachment A.pdf

Viewed: 3/2/2022 10:46:09 AM
 Read: Not Required
 Accepted: Not Required

Melani Pedroza
 melani.pedroza@kingcounty.gov
 Clerk of the Council
 King County Council
 Security Level: Email, Account Authentication (None)

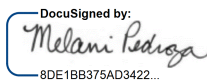
DocuSigned by:

 8DE1BB375AD3422...
 Signature Adoption: Uploaded Signature Image
 Using IP Address: 198.49.222.20

Sent: 3/2/2022 10:46:19 AM
 Viewed: 3/2/2022 10:57:30 AM
 Signed: 3/2/2022 10:57:38 AM

Electronic Record and Signature Disclosure:

Not Offered via DocuSign
 Supplemental Documents:

Motion 16050 Attachment A.pdf

Viewed: 3/2/2022 10:57:34 AM
 Read: Not Required
 Accepted: Not Required

In Person Signer Events**Signature****Timestamp****Editor Delivery Events****Status****Timestamp****Agent Delivery Events****Status****Timestamp****Intermediary Delivery Events****Status****Timestamp****Certified Delivery Events****Status****Timestamp****Carbon Copy Events****Status****Timestamp**

Witness Events	Signature	Timestamp
-----------------------	------------------	------------------

Notary Events	Signature	Timestamp
----------------------	------------------	------------------

Envelope Summary Events	Status	Timestamps
--------------------------------	---------------	-------------------

Envelope Sent	Hashed/Encrypted	3/2/2022 10:18:53 AM
Certified Delivered	Security Checked	3/2/2022 10:57:30 AM
Signing Complete	Security Checked	3/2/2022 10:57:38 AM
Completed	Security Checked	3/2/2022 10:57:38 AM

Payment Events	Status	Timestamps
-----------------------	---------------	-------------------