



King County

KING COUNTY

1200 King County Courthouse
516 Third Avenue
Seattle, WA 98104

Signature Report

March 23, 2009

Ordinance 16404

Proposed No. 2009-0060.1

Sponsors Constantine

1 AN ORDINANCE authorizing and approving the 2008
2 office of the public defender contracts for legal services.
3

4 STATEMENT OF FACTS:

5 1. K.C.C. 2.60.040 requires King County council approval of all legal
6 services contracts entered into by the administrator of the office of the
7 public defender.

8 2. The county executive through the department of community and human
9 services has completed contract negotiations with four defender
10 associations for 2008 legal defense services.

11 BE IT ORDAINED BY THE COUNCIL OF KING COUNTY:
12

13 The King County council authorizes and approves the attached 2008 defender
14 association contracts for legal services.

15

Ordinance 16404 was introduced on 1/26/2009 and passed by the Metropolitan King
County Council on 3/23/2009, by the following vote:

Yes: 9 - Mr. Constantine, Mr. Ferguson, Ms. Hague, Ms. Lambert, Mr. von
Reichbauer, Mr. Gossett, Mr. Phillips, Ms. Patterson and Mr. Dunn

No: 0

Excused: 0

KING COUNTY COUNCIL
KING COUNTY, WASHINGTON



Dow Constantine, Chair

ATTEST:

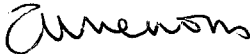

Anne Noris, Clerk of the Council

APPROVED this 27 day of MARCH, 2009.



Ron Sims, County Executive

Attachments A. Associated Counsel for the Accused--D37884D, B. Northwest Defenders
Association--D37885D, C. Society of Counsel Representing Accused Persons--
D37886D, D. The Defender Association--D37887D

RECEIVED
2009 MAR 30 AM 8:46
CLERK
KING COUNTY COUNCIL

King County Contract No. D37884D
Federal Taxpayer ID No. 91-0910677

Department/Division Community and Human Services/Office of the Public Defender
Agency Associated Counsel for the Accused
Project Title Public Defense Legal Services
Contract Amount \$9,098,187.50 Fund Code 00000010
Contract Period From: January 1, 2008 To December 31, 2008

KING COUNTY AGENCY SERVICES CONTRACT – 2008

THIS CONTRACT is entered into by KING COUNTY (the "County"), and Associated Counsel for the Accused, whose address is 110 Prefontaine Place South, Suite 200, Seattle, WA 98104, (the "Agency").

WHEREAS, the County desires to have legal services, as described in the Contract, performed for indigent persons legally entitled to appointed counsel in King County courts and as authorized by Ordinance No. 15652; and

WHEREAS, the Agency is a nonprofit law firm, incorporated under the Washington Nonprofit Corporation Code, within the meaning of Section 501(c)(3) of the Internal Revenue Code, organized and operated exclusively for the purpose of providing court-appointed legal services to indigent persons; and

WHEREAS, the County and the Agency agree that these legal services are provided by an independent contractor non-profit corporation, possessing all of the rights, duties and obligations that are possessed under Washington State law and applicable Federal laws for an independent contractor service provider; and

WHEREAS, the County and the Agency agree that any and all funds provided pursuant to this Contract are provided for the sole purpose of provision of legal services to indigent persons assigned to the Agency by the County Office of The Public Defender (OPD) or the courts of King County.

NOW THEREFORE, in consideration of payments, covenants, and agreements hereinafter mentioned, to be made and performed by the parties hereto, the parties covenant and do mutually agree as follows:

I. SCOPE OF SERVICES

The Agency shall provide services and comply with the requirements set forth hereinafter and in the following attached exhibits, which are incorporated herein by reference:

This form is available in alternate formats for people with disabilities upon request.

- | | | |
|-------------------------------------|--|--------------------------------|
| <input checked="" type="checkbox"/> | <u>Certificate of Insurance/Endorsements</u> | Attached hereto as Exhibit I |
| <input checked="" type="checkbox"/> | <u>Personnel Inventory Report</u> | Attached hereto as Exhibit II |
| <input checked="" type="checkbox"/> | <u>Affidavit of Compliance</u> | Attached hereto as Exhibit III |
| <input checked="" type="checkbox"/> | <u>504/ADA Assurance of Compliance</u> | Attached hereto as Exhibit IV |
| <input checked="" type="checkbox"/> | <u>Public Defense Legal Services</u> | Attached hereto as Exhibit V |

II. DURATION OF CONTRACT

This Contract shall commence on the 1st day of January 2008, and shall terminate on the 31st day of December 2008 ("Contract Term"), unless terminated earlier, pursuant to the terms and conditions of the Contract. This Contract may be extended by agreement of the parties for a period of up to three months in order to complete negotiations and/or receive necessary approval of a subsequent year contract. An amendment to extend the contract duration may reflect adjustments to payment and casework schedule reflective of planned changes for subsequent year.

III. COMPENSATION AND METHOD OF PAYMENT

A. The County shall pay the Agency for satisfactory performance of the services and requirements specified in this Contract, payable in the following manner:

As defined in Exhibit V, Section IV, for Public Defense Legal Services.

B. The Agency shall submit all outstanding reports within 20 days of the date this Contract terminates. If any of the Agency's reports which are due to the County are not submitted by the day specified in this subsection, the County may withhold payment to the Agency until such time as reports are submitted and approved.

IV. OPERATING BUDGET

The funds provided by the County to the Agency pursuant to the terms of this Contract are solely for expenses that are directly and legitimately related to the performance of the provisions of this Contract. In the event the County, determines that funds paid pursuant to this Contract were expended for any purposes other than those set forth in this Contract, such expenditure shall constitute a material breach of this Contract. Income and expenses, including prorated overhead costs, for Sexually Violent Predator cases and any other services funded by the State DSHS shall be reported and traceable in a method consistent with accounting standards noted below. If the Agency receives any revenue from any other source, the costs paid, including prorated overhead, for work done with that revenue shall be reported and traceable according to the accounting standards noted below.

V. INTERNAL CONTROL AND ACCOUNTING SYSTEM

The Agency shall establish and maintain a system of accounting and internal controls that comply with generally accepted accounting principles and financial reporting standards applicable to publicly supported not-for-profit corporations as prescribed by the Financial Accounting Standards Board.

VI. MAINTENANCE OF RECORDS

- A. The Agency shall maintain accounts and records, including personnel, property, financial, and programmatic records and other such records as may be deemed necessary by the County to ensure proper accounting for all Contract funds and compliance with this Contract.
- B. These records shall be maintained for a period of six years after termination hereof unless permission to destroy them is granted by the Office of the Archivist in accordance with Revised Code of Washington (RCW) Chapter 40.14.
- C. The Agency shall inform the County in writing of the location, if different from the Agency address listed on page one of this Contract, of the aforesaid books, records, documents and other evidence and shall notify the County in writing of any changes in location within ten working days of any such relocation.

VII. AUDITS

- A. The Agency shall have an independent audit, conducted by a certified public accountant, of its financial statement and condition, which shall comply with generally accepted auditing standards for not-for-profit organizations as prescribed by the American Institute of Certified Public Accountants. The independent auditor's report shall include a management letter listing any reportable conditions or internal control weaknesses, or stating that no reportable conditions or control weaknesses were noted. The auditor's report shall include a copy of the Agency's management representation letter. Any independent auditor hired by the Agency to fulfill the Contract audit requirements must agree to provide access to audit working papers if requested by the County.
- B. The Agency shall provide a copy of the audit report to each County division providing financial assistance to the Agency no later than the last business day of August. The Agency fiscal year shall be the same as a calendar year. The Agency shall provide to the County its response and corrective action plan for all findings and reportable conditions contained in its audit. The Agency shall provide the County with a copy of its IRS Form 990 (Return of Organization Exempt from Tax) when it is filed with the IRS.
- C. The Agency's annual financial statements shall be prepared recognizing all Agency fund accounts at the end of the Contract Term.
- D. Any and all accounts must be invested in a fiscally prudent fashion under the non-profit corporation law of Washington and applicable Federal laws. Prepayments, as noted in Exhibit V, Section IV, J shall be invested in a cash equivalent account, defined as a highly liquid, short term investment with little risk of loss in value.
- E. Additional federal and/or state audit or review requirements may be imposed on the County, and to the extent that such requirements relate to funding that is passed on to the Agency, the Agency shall be required to comply with any such requirements. The County shall notify the Agency when requirements from funders are issued to the County.

VIII. EVALUATIONS AND INSPECTIONS

- A. Upon reasonable notice, the Agency shall provide right of access to its facilities, including those of any subcontractor, to the County, the state, and/or federal agencies

or officials at all reasonable times for the purpose of monitoring and evaluating the services provided under this Contract. The County shall give advance notice to the Agency in the case of fiscal audits to be conducted by the County.

- B. The records and documents with respect to all matters covered by this Contract, not including entire individual personnel files but may include specific requested documentation, shall be subject to inspection, review, or audit by the County (and to the extent Contract funds paid by the County are derived from federal and/or state sources, also by federal and/or state officials so authorized by law) during the Contract Term and six years thereafter, unless a longer record retention period is required by law and in such case, the right of inspection shall extend until the end of the applicable retention period.
- C. The Agency agrees to cooperate with the County or its agent in the evaluation of the Agency's performance under this Contract and to make available all information reasonably required by any such evaluation process or ongoing reporting requirements established by the County. The results and records of said evaluations and reports shall be maintained and disclosed in accordance with RCW Chapter 42.17.

IX. CORRECTIVE ACTION

The County and Agency agree that when operational or performance issues arise in the course of providing the services of this Contract, a resolution of an issue or concern will be attempted at the lowest administrative level possible, although generally contact with the Agency shall include the managing director.

If the County determines that a performance concern has not been rectified at a less formal level and/or that a breach of contract has occurred, that is, the Agency has failed to comply with any terms or conditions of this Contract or the Agency has failed to provide in any manner the work or services agreed to herein, and if the County deems said breach to warrant written corrective action, the following sequential procedure shall apply:

- A. The County shall notify the Agency in writing of the nature of the breach;

The Agency shall respond in writing within three working days of its receipt of such notification, which response shall indicate the steps being taken to correct the specified deficiencies. The corrective action plan shall specify the proposed completion date for bringing the Agency into Contract compliance, which date shall not be more than 30 days from the date of the County's approval of the Agency's plan, unless the County, at its sole discretion, specifies in writing an extension in the number of days to complete the corrective actions;
- B. The County shall notify the Agency in writing of the County's determination as to the sufficiency of the Agency's corrective action plan within ten days of receipt, or longer with written notification to the Agency. The determination of sufficiency of the Agency's corrective action plan shall be at the sole discretion of the County, provided that the County shall take into consideration the reasonableness of the proposed corrective action in light of the breach;
- C. In the event that the Agency does not respond within the appropriate time with a corrective action plan, or the Agency's corrective action plan is determined by the County to be insufficient, the County may commence termination of this Contract in whole or in part pursuant to Section XI.A. if the breach is material;

- D. In addition to and not in lieu of any of its other contractual or legal rights or remedies, the County, in its sole discretion, may withhold any payment owed the Agency hereunder or prohibit the Agency from incurring additional financial obligations, except to the extent such obligations are required by court order or deemed by the County as necessary for the competent and adequate representation of indigent persons assigned to the Agency, until the County is satisfied that corrective action has been taken or completed; and
- E. The County may choose to use corrective action in response to any type of breach by the Agency. The choice of corrective action or termination under Section XI for a material breach is within the County's sole discretion. Nothing herein shall be deemed to affect or waive any rights the parties may have pursuant to Section XI. Nor shall the exercise of any right within this section be deemed to be a breach of this Contract by the County.

X. ASSIGNMENT/SUBCONTRACTING

- A. The Agency shall not assign or subcontract any portion of the Legal Services, as defined in Exhibit V, supervision or training which is provided under this Contract or transfer or assign any claim arising pursuant to this Contract without the written consent of the County. Said consent must be sought in writing by the Agency not less than 15 days prior to the date of any proposed assignment. The definition of training, within this subsection only, does not include CLE's. The Agency may contract for training services up to a cumulative amount of \$10,000.00 in a contract year, without seeking consent of the County. These excluded contracts and CLE costs must be reported to the County, as noted in Paragraph X. B. of this Section.
- B. The Agency shall keep all records of any contracts or purchases of goods or services related to this Contract. The Agency shall be required to report these expenditures to the County and the original records may be subject to audit at the County's request.

XI. TERMINATION

- A. The County may terminate this Contract, in whole or in part, upon seven days advance written notice in the event: (1) the Agency breaches any material duty, obligation, or service required pursuant to this Contract, (2) the Agency or any of its officers, directors, employees, subcontractors, agents or representatives engages in the misappropriation or mismanagement of Contract funds or the fraudulent disbursement of Contract funds, (3) the Agency or any of its officers, directors, agents, representatives or designees makes a material misrepresentation regarding the Agency, its finances and/or scope of activities to its independent accountant, auditor, the County, and/or any other agencies or instrumentalities of the federal, state or local government or commits any act or omission that jeopardizes the Agency's tax-exempt status under Code section 501(c)(3) or (4) the duties, obligations, or services required herein become impossible, illegal, or not feasible. The County's termination notice does not bar the Agency from seeking injunctive relief or any other equitable relief available under current Washington State law.

If the Contract is terminated by the County pursuant to (1), (2), or (3) in the first paragraph of XI. A., the Agency shall be liable for damages, including any additional reasonable costs of procurement of similar services from another source.

In the event the County terminates the Contract due to (1), (2), or (3) in the first paragraph of XI. A., or any act or omission which jeopardizes the Agency's tax-exempt

status under IRS Code Section 501(c)(3), then subject to the provisions of this Section, the Agency shall return to the County any funds misappropriated and paid to the Agency by the County under the current Contract and from any available source, including funds from a prior contract. In addition, the Agency shall return such funds determined by the County to be reasonable and necessary to provide legal services, as defined in Exhibit V, for the balance of the Contract term, or until the County is able to obtain a successor agency to provide such services, whichever period is less. This provision and the obligations contained herein shall survive the termination or expiration of this Contract.

The Agency may terminate this Contract, in whole or in part, prior to the end of the Contract Term, by providing the County seven days advance written notice, in the event the County commits any material breach of this Contract caused by non-payment or partial termination of caseload area or geographic location of services by the County without a negotiated amendment.

- B. In the event of the termination of this Contract the Agency shall remit any unexpended balance of funds paid, including prepaid funds for cases assigned and not completed, less the amount the County and the Agency agree shall be necessary to enable the Agency to deliver services in those cases notwithstanding the termination. Nothing herein shall limit, waive, or extinguish any right or remedy provided by this Contract or law that either party may have in the event that the obligations, terms, and conditions set forth in this Contract are breached by the other party.
- C. If County expected or actual funding is withdrawn, reduced, or limited in any way prior to the termination date set forth above in Section II, the County may, upon 15 days written notification to the Agency, terminate this Contract in whole or in part.

If the Contract is terminated as provided in this Subsection: (1) the County shall be liable only for payment in accordance with the terms of this Contract for services rendered prior to the effective date of termination; and (2) the Agency shall be released from any obligation to provide such further services pursuant to the Contract as are affected by the termination.

- D. This Contract may be terminated for convenience by either party, prior to the date specified in Section II, by providing 60 days advance written notice of the termination.

XII. DISPUTE RESOLUTION

Agency disputes pertaining to County decisions regarding Contract compliance issues shall be made in writing to The Public Defender. The written dispute shall include the decision being questioned and the point on which the dispute is made. This is a non-exclusive remedy.

The Public Defender shall make a determination decision and respond in writing to the Agency within 15 days of receipt. If the Agency wishes to appeal The Public Defender decision, an additional letter indicating all points of the dispute resolution process to date shall be sent to the Director of the Department of Community and Human Services. The Department Director shall make a final determination and respond in writing to the Agency within 30 days of the Department Director's Office receipt of the appeal notice from the Agency.

Nothing herein shall impair the procedure of Section IX above nor the ability of either party to terminate this Contract as set forth in Section XI above.

XIII. FUTURE SUPPORT

- A. The County makes no assurance or commitment to the Agency for a subsequent contract or extension of the effective dates of the Contract for the services contracted for herein. Funding or obligation under this Contract beyond the current appropriation year is conditional upon appropriation by the County Council of sufficient funds to support the activities described in the Contract. Should such appropriation not be approved, this Contract shall terminate at the close of the current appropriation year.
- B. Should the County or Agency terminate this Contract or not renew this Contract for services in a subsequent period, the County shall work with the Agency to provide appropriate transition planning for assigned Agency clients to ensure their defense is not jeopardized by actions of the Agency or the County.

XIV. HOLD HARMLESS AND INDEMNIFICATION

- A. In providing services under this Contract, the Agency is an independent contractor, and neither it nor any of its officers, directors, employees, subcontractors, agents, or representatives are employees of the County for any purpose. The Agency shall be responsible for all federal and/or state tax, industrial insurance, and Social Security liability that may result from the performance of and compensation for these services and shall make no claim of career service or civil service rights which may accrue to a County employee under state or local law.

The County assumes no responsibility for the payment of any compensation, wages, benefits, or taxes, by, or on behalf of the Agency, its employees, and/or others by reason of this Contract. The Agency shall protect, indemnify, and save harmless the County, its officers, officials, agents, and employees from and against any and all claims, costs, and/or losses whatsoever occurring or resulting from (1) the Agency's failure to pay any such compensation, wages, benefits, or taxes, and/or (2) the supplying to the Agency of work, services, materials, or supplies by Agency employees or other suppliers in connection with or support of the performance of this Contract.

- B. The Agency further agrees that it is financially responsible for and shall repay the County all amounts determined by a fiscal audit exception which occur due to the negligence, intentional act, and/or failure, for any reason, to comply with the terms of this Contract by the Agency, its officers, directors, employees, subcontractors, agents, and/or representatives.
- C. Should it become necessary to institute legal action in order to recoup any funds due and owing to the County or the Agency pursuant to any of the terms of this Contract, the non-prevailing party agrees it is financially responsible and liable for the prevailing attorneys' fees and costs. Each party's duty to repay shall not be diminished or extinguished by the prior termination of the Contract pursuant to any provision hereof.
- D. The Agency shall protect, defend, indemnify, and save harmless the County, its officers, officials, employees, and agents from any and all costs, claims, judgments, and/or awards of damages, arising out of, or in any way resulting from, the negligent acts or omissions of the Agency, its officers, directors, employees, subcontractors, agents, and/or representatives in performance and/or non-performance of its obligations under this Contract. The Agency agrees that its obligations under this subparagraph extend to any claim, demand, and/or cause of action brought by, or on behalf of, any of its employees or agents. For this purpose, the Agency, by mutual

negotiation, hereby waives, as respects the County only, any immunity that would otherwise be available against such claims under the Industrial Insurance provisions of Title 51 RCW. In the event the County incurs any judgment, award, and/or cost arising therefrom including attorneys' fees to enforce the provisions of this article, all such fees, expenses, and costs shall be recoverable from the Agency.

- E. The County shall protect, defend, indemnify, and hold harmless the Agency, its officers, directors, employees, agents, and representatives from any and all costs, claims, judgments, and/or awards of damages, arising out of, or in any way resulting from, the negligent acts or omissions of the County, its officers, officials, employees, or agents. The County agrees that its obligations under this subparagraph extends to any claim, demand, and/or cause of action brought by, or on behalf of, any of its employees or agents. For this purpose, the County, by mutual negotiation, hereby waives, as respects the Agency only, any immunity that would otherwise be available against such claims under the Industrial Insurance provisions of Title 51 RCW. In the event the Agency incurs any judgment, award, and/or cost arising therefrom including attorneys' fees to enforce the provisions of this article, all such fees, expenses, and costs shall be recoverable from the County.

Claims shall include, but not be limited to, assertions that the use or transfer of software, book, document, report, film, tape, or sound reproduction or material of any kind, delivered hereunder, constitutes an infringement of any copyright, patent, trademark, trade name, and/or otherwise results in unfair trade practice.

- F. To the extent that an Agency subcontractor fails to satisfy its obligation to defend and indemnify the County as detailed in Section XVIII.B. of this Contract, the Agency shall protect, defend, indemnify, and hold harmless the County, its officers, employees and agents from any and all costs, claims, judgments, and/or awards or damages arising out of, or in any way resulting from, the negligent act or omissions of the Agency's subcontractor, its officers, employees, and/or agents in connection with or in support of this Contract.
- G. Nothing contained within this provision shall affect and/or alter the application of any other provision contained within this Contract.

XV. INSURANCE REQUIREMENTS

- A. By the date of execution of this Contract, the Agency shall procure and maintain for the duration of this Contract, insurance against claims for injuries to persons or damages to property which may arise from, or is in connection with, the performance of work hereunder by the Agency, its agents, representatives, employees, and/or subcontractors. The costs of such insurance shall be paid by the Agency or subcontractor. The Agency must furnish separate certificates of insurance and policy endorsements for each subcontractor as evidence of compliance with the insurance requirements of this Contract. The Agency is responsible for ensuring compliance with all of the insurance requirements stated herein. Failure by the Agency, its agents, employees, officers, and or subcontractors, to comply with the insurance requirements stated herein shall constitute a material breach of this Contract.

For All Coverages: Each insurance policy shall be written on an "occurrence" form; except that insurance on a "claims made" form may be acceptable with prior County approval.

If coverage is approved and purchased on a "claims made" basis, the Agency warrants continuation of coverage, either through policy renewals or the purchase of an extended discovery period, if such extended coverage is available, for not less than three years from the date of Contract termination, and/or conversion from a "claims made" form to an "occurrence" coverage form.

By requiring such minimum insurance, the County shall not be deemed or construed to have assessed the risks that may be applicable to the Agency under this Contract. The Agency shall assess its own risks and, if it deems appropriate and/or prudent, maintain greater limits and/or broader coverage.

Nothing contained within these insurance requirements shall be deemed to limit the scope, application and/or limits of the coverage afforded by said policies, which coverage shall apply to each insured to the full extent provided by the terms and conditions of the policy(s). Nothing contained within this provision shall affect and/or alter the application of any other provision contained within this Contract.

B. Minimum Scope of Insurance

Coverage shall be at least as broad as:

1. General Liability:

Insurance Services Office form number (CG 00 01 Ed. 11-88) covering **COMMERCIAL GENERAL LIABILITY**.

2. Professional Liability:

Professional Liability, Errors, and Omissions coverage. In the event that services delivered pursuant to this Contract either directly or indirectly involve or require professional services, Professional Liability, Errors, and Omissions coverage shall be provided. "Professional Services", for the purpose of this Contract section, shall mean any services provided by a licensed professional or those services that require a professional standard of care.

3. Automobile Liability:

In the event that services delivered pursuant to this Contract require the use of a vehicle or involve the transportation of clients by Agency personnel in Agency-owned vehicles or non-owned vehicles, the Agency shall provide evidence of the appropriate automobile coverage.

Insurance Services Office form number (CA 00 01 Ed. 12-90) covering **BUSINESS AUTO COVERAGE**, symbol 1 "any auto"; or the appropriate coverage provided by symbols 2, 7, 8, or 9.

4. Workers' Compensation:

Workers' Compensation coverage, as required by the Industrial Insurance Act of the State of Washington, as well as any similar coverage required for this work by applicable federal or "Other States" state law.

5. Stop Gap/Employers Liability:

Coverage shall be at least as broad as the protection provided by the Workers' Compensation policy Part 2 (Employers Liability) or, in states with monopolistic state funds, the protection provided by the "Stop Gap" endorsement to the general liability policy.

C. Minimum Limits of Insurance

The Agency shall maintain limits no less than, for:

1. General Liability: \$1,000,000 combined single limit per occurrence by bodily injury, personal injury, and property damage, and for those policies with aggregate limits, a \$2,000,000 aggregate limit.
2. Professional Liability, Errors, and Omissions: \$2,000,000 per claim and in the aggregate.
3. Automobile Liability: \$1,000,000 combined single limit per accident for bodily injury and property damage. Except if the transport of clients by Agency personnel is involved, then Risk Management shall review the appropriate amount of coverage.
4. Workers' Compensation: Statutory requirements of the state of residency.
5. Stop Gap/Employers Liability: \$1,000,000.

D. Deductibles and/or Self-insured Retentions

Any deductibles or self-insured retentions greater than \$10,000 must be declared to, and approved by, the County. The deductible and/or self-insured retention of the policies shall not apply to the Agency's liability to the County and shall be the sole responsibility of the Agency.

E. Other Insurance Provisions

The insurance policies required in this Contract are to contain, or be endorsed to contain, the following provisions:

1. Liability Policies Except Professional and Workers Compensation
 - a. The County, its officers, officials, employees, and agents are to be covered as additional insureds as respects liability arising out of activities performed by or on behalf of the Agency in connection with this Contract.
 - b. The Agency's insurance coverage shall be primary insurance as respects the County, its officers, officials, employees, and agents. Any insurance and/or self-insurance maintained by the County, its offices, officials, employees, or agents shall not contribute with the Agency's insurance or benefit the Agency in any way.
 - c. The Agency's insurance shall apply separately to each insured against whom claim is made and/or lawsuit is brought, except with respect to the limits of the insurer's liability.

2. All Policies

Coverage shall not be suspended, voided, canceled, reduced in coverage or in limits, except by the reduction of the applicable aggregate limit by claims paid, until after 45 days prior written notice has been given to the County.

F. Acceptability of Insurers

Unless otherwise approved by the County,

Insurance is to be placed with insurers with a Bests' rating of no less than A:VIII, or, if not rated with Bests, with minimum surpluses the equivalent of Bests' surplus size VIII.

Professional Liability, Errors, and Omissions insurance may be placed with insurers with a Bests' rating of B+VII. Any exception must be approved by King County.

If, at any time, the foregoing policies shall fail to meet the above minimum requirements the Agency shall, upon notice to that effect from the County, promptly obtain a new policy, and shall submit the same to the County, with appropriate certificates and endorsements, for approval.

G. Verification of Coverage

The Agency shall furnish the County certificates of insurance and endorsements required by this Contract. Such certificates and endorsements, and renewals thereof, shall be attached as exhibits to the Contract. The certificates and endorsements for each insurance policy are to be signed by a person authorized by that insurer to bind coverage on its behalf. The certificates and endorsements for each insurance policy are to be on forms approved by the County prior to the commencement of activities associated with the Contract. The County reserves the right to require complete, certified copies of all required insurance policies at any time.

H. Subcontractors

The Agency shall include all subcontractors as insureds under its policies or shall furnish separate certificates of insurance and policy endorsements from each subcontractor. Insurance coverages provided by subcontractors as evidence of compliance with the insurance requirements of this Contract shall be subject to all of the requirements stated herein.

XVI. NONDISCRIMINATION AND EQUAL EMPLOYMENT OPPORTUNITY

A. Nondiscrimination in Employment Provision of Services

During the Contract Term, neither the Agency nor any party subcontracting under the authority of this Contract shall discriminate or tolerate harassment on the basis of race, color, sex, religion, national origin, marital status, sexual orientation, age, or the presence of any sensory, mental, or physical disability in the employment or application for employment or in the administration or delivery of services or any other benefits under this Contract.

B. Equal Benefits to Employees with Domestic Partners

Pursuant to Ordinance 14823, King County's "Equal Benefits" (EB) ordinance, and related administrative rules adopted by the County Executive, as a condition of award of a contract valued at \$25,000 or more, the Contractor agrees that it shall not discriminate in the provision of employee benefits between employees with spouses, and employees with domestic partners during the performance of this Contract. Failure to comply with this provision shall be considered a material breach of this Contract, and may subject the Contractor to administrative sanctions and remedies for breach.

When the contract is valued at \$25,000 or more, the Contractor shall complete a Worksheet and Declaration form for County review and acceptance prior to Contract execution. The EB Compliance forms, Ordinance 14823 (which is codified at KCC Chapter 12.19), and related administrative rules are incorporated herein by reference. They are also available online at:
<http://www.metrokc.gov/procurement/services/eb.aspx>

C. Nondiscrimination in Subcontracting Practices

During the solicitation, award and term of this Contract, the Agency shall not create barriers to open and fair opportunities to participate in County contracts or to obtain or compete for contracts and subcontracts as sources of supplies, equipment, construction and services. In considering offers from and doing business with subcontractors and suppliers, the Agency shall not discriminate against any person on the basis of race, color, religion, sex, age, national origin, marital status, sexual orientation or the presence of any mental or physical disability in an otherwise qualified disabled person.

D. Compliance with Laws and Regulations

The Agency shall comply fully with all applicable federal, state and local laws, ordinances, executive orders and regulations that prohibit discrimination. These laws include, but are not limited to, KCC 12.17, RCW Chapter 49.60, Titles VI and VII of the Civil Rights Act of 1964, 42 U.S.C. 2000(a) et seq., the Americans with Disabilities Act, 42 U.S.C. 12101 et seq., and the Restoration Act of 1987. The Agency shall further comply fully with any affirmative action requirements set forth in any federal regulations, statutes or rules included or referenced in the Contract.

E. Small Business and Minority and Women Business Enterprise Opportunities

The County encourages the Agency to utilize small businesses, including Minority-owned and Women-owned Business Enterprises ("M/WBEs") in County contracts. The County encourages the Agency to use the following voluntary practices to promote open competitive opportunities for small businesses, including M/WBEs:

1. Attending a pre-bid or pre-solicitation conference, if scheduled by the County, to provide project information and to inform small businesses and other firms of contracting and subcontracting opportunities;
2. Placing all qualified small businesses, attempting to do business in King County, including M/WBEs, on solicitation lists, and providing written notice of subcontracting opportunities to these firms capable of performing the work, including without limitation all businesses on any list provided by the County, in sufficient time to allow such businesses to respond to the written solicitations;

3. Breaking down total requirements into smaller tasks or quantities, where economically feasible, in order to permit maximum participation by small businesses, including M/WBEs;
4. Establishing delivery schedules, where the requirements of this Contract permit, that encourage participation by small businesses, including M/WBEs;
5. Providing small businesses, including M/WBEs that express interest with adequate and timely information about plans, specifications, and requirements of the Contract;
6. Using the services of available community organizations, contractor groups, local assistance offices, the County, and other organizations that provide assistance in the recruitment and placement of small businesses, including M/WBEs; and,
7. The Washington State Office of Minority and Women's Business Enterprises (OMWBE) can provide a list of certified M/WBEs. Contact OMWBE office at 360-753-9693 or on-line through the web site at www.wsdot.wa.gov/omwbe/.

F. Equal Employment Opportunity

The Agency shall implement and carry out the obligations in its Affidavit and Certificate of Compliance regarding equal employment opportunity, and all other requirements as set forth in the Affidavit and Certificate of Compliance.

G. Fair Employment Practices

King County Code Chapter 12.18 is incorporated by reference as if fully set forth herein and such requirements apply to this Contract. During the performance of this Contract, neither the Agency nor any party subcontracting under the authority of this Contract shall engage in unfair employment practices. It is an unfair employment practice for any:

1. Employer or labor organization to discriminate against any person with respect to referral, hiring, tenure, promotion, terms, conditions, wages or other privileges of employment;
2. Employment agency or labor organization to discriminate against any person with respect to membership rights and privileges, admission to or participation in any guidance program, apprenticeship training program, or other occupational training program;
3. Employers, employment agency, or labor organization to print, circulate, or cause to be printed, published or circulated, any statement, advertisement, or publication relating to employment or membership, or to use any form of application therefore, which indicates any discrimination unless based upon a bona fide occupation qualification;
4. Employment agency to discriminate against any person with respect to any reference for employment or assignment to a particular job classification;
5. Employer, employment agency or a labor organization to retaliate against any person because that person has opposed any practice forbidden by KCC

Chapter 12.18 or because that person has made a charge, testified or assisted in any manner in any investigation, proceeding or hearing initiated under the provisions of KCC Chapter 12.18;

6. Publisher, firm, corporation, organization or association printing, publishing or circulating any newspaper, magazine or other written publication to print or cause to be printed or circulated any advertisement with knowledge that the same is in violation of KCC Chapter 12.18.030.C., or to segregate and separately designate advertisements as applying only to men or women unless such discrimination is reasonably necessary to the normal operation of the particular business, enterprise or employment, unless based upon a bona fide occupational qualification;
7. Employer to prohibit any person from speaking in a language other than English in the workplace unless:
 - a. The employer can show that requiring that employees speak English at certain times is justified by business necessity, and
 - b. The employer informs employees of the requirement and the consequences of violating the rule.
8. If the Agency engages in unfair employment practices as defined above, remedies as set forth in KCC Chapter 12.18 may be applied.

H. Record-Keeping Requirements and Site Visits

The Agency shall maintain, for at least six years after completion of all work under this Contract, the following:

1. Records of employment, employment advertisements, application forms, and other pertinent data, records and information related to employment, and solicited applications for employment; and
2. Records, including written quotes, bids, estimates or proposals submitted to the Agency by all businesses responding to Agency solicitation, and any other information necessary to document the actual use of and payments to subcontractors and suppliers in this Contract, including employment records.

The County may visit upon reasonable notice, at any reasonable time, the site of the work and the Agency's office to review the foregoing records. The Agency shall provide every assistance requested by the County during such visits. In all other respects, the Agency shall make the foregoing records available to the County for inspection and copying any reasonable volume of documents upon request. If this Contract involves federal funds, the Agency shall comply with all record keeping requirements set forth in any federal rules, regulations or statutes included or referenced in this Contract and the Exhibits attached.

I. Sanctions for Violations

Any violation of the mandatory requirements of the provisions of this Section shall be a material breach of this Contract for which the Agency may be subject to damages, withhold of payment and any other sanctions provided for by this Contract and by applicable law.

J. Reporting

1. The Agency shall submit with this Contract a total Personnel Inventory Report providing employment data for minorities, females, and persons with disabilities.

Subject to the provisions of KCC Chapter 12.16.060, the Agency's Personnel Inventory Report shall be effective for two years after the date on which the report was submitted.

2. The Agency also shall submit an Affidavit of Compliance in the form provided by the County, demonstrating commitment to comply with the provisions of KCC Chapter 12.16 in accordance with Paragraph A of this Section.

The Agency shall complete the Affidavit of Compliance provided by the County and attach the original, notarized, completed form to this Contract. Subject to the provisions of KCC Chapter 12.16.060, the Agency's Affidavit of Compliance shall be effective for two years after the date on which the report was submitted.

If the Agency engages in unfair employment practices as defined above, remedies as set forth in KCC Chapter 12.18 shall be applied as well as any other remedies by law.

The Agency shall complete all reports and forms (including Department of Social and Health Services non-discrimination forms, where applicable) provided by the County and shall otherwise cooperate fully with the County in monitoring and assisting the Agency in providing nondiscriminatory programs.

XVII. SECTION 504 AND AMERICANS WITH DISABILITIES ACT

The Agency has completed a 504/ADA Self-Evaluation Questionnaire for all programs and services offered by the Agency (including any services not subject to this Contract), and has evaluated its services, programs and employment practices for compliance with Section 504 of the Rehabilitation Act of 1973, 29 U.S.C. 701 et seq. as amended ("504") and the ADA, 42 U.S.C. 12101 et seq. The Agency has completed, attached as an Exhibit to this Contract, and incorporated herein by reference a 504/ADA Assurance of Compliance.

XVIII. SUBCONTRACTS AND PURCHASES

- A. The Agency shall include the above Sections IV, V, VI, VII, VIII, XIII, XIV, XV, XVI, and XVII, in every subcontract or purchase agreement for services which relate to the subject matter of this Contract.

- B. The Agency agrees to include the following language verbatim in every subcontract, provider agreement, or purchase agreement for services which are the subject matter of this Contract:

"[Subcontractor] shall protect, defend, indemnify, and hold harmless King County, its officers, employees and agents from any and all costs, claims, judgments, and/or awards of damages arising out of, or in any way resulting from the negligent act or omissions of subcontractor, its officers, employees, and/or agents in connection with or in support of this Contract. Subcontractor expressly agrees and understands that King

County is a third party beneficiary to this Contract and shall have the right to bring an action against subcontractor to enforce the provisions of this paragraph."

XIX. CONFLICT OF INTEREST

- A. The Agency agrees that it will not willfully attempt to secure preferential treatment in its dealings with the County by offering any valuable consideration, thing of value or gift, whether in the form of services, loan, thing or promise, in any form to any County official or employee. The Agency acknowledges that if it is found to have violated the prohibition found in this paragraph, its current contracts with the County shall be cancelled and it shall not be able to bid on any County contract for a period of two years.
- B. The Agency acknowledges that for one year after leaving County employment, a former County employee may not have a financial or beneficial interest in a contract or grant that was planned, authorized, or funded by a County action in which the former County employee participated during County employment. Agency shall identify, at the time of offer, current or former County employees involved in the preparation of proposals or the anticipated performance of work if awarded the Contract. Failure to identify current or former County employees involved in this transaction may result in the County's denying or terminating this Contract. Before making an employment offer to a person who has less than a year separation from County employment, the Agency shall confirm with the person being tended the employment offer of their compliance with KCC Chapter 3.04 and this paragraph.
- C. Failure to comply with this Section XIX shall be a material breach of this Contract, and may result in termination of this Contract pursuant to Section XI and subject the Agency to the remedies stated therein, or otherwise available to the County at law or in equity.

XX. BOARD OF DIRECTORS

The Agency shall qualify at all times as a non-profit corporation under U.S.C., Subtitle A., Chapter 1, Subchapter F, Part 1, and Section 501(c)(3).

The Agency shall have an active, legally constituted board of directors in accordance with RCW Chapters 23B or 24 that shall be comprised of neither employees nor relatives of employees, officers or directors of the Agency, except as approved by the County under this Section. The Director may be an ex officio member of the Board of Directors. For the purposes of this Section, a relative is defined as a husband, wife, father, father-in-law, mother, mother-in-law, brother, brother-in-law, sister, sister-in-law, son-in-law, daughter-in-law, niece, nephew, grandparent, grandchild, uncle, aunt, child, child of domestic partner, and domestic partner. In addition, the relatives of a domestic partner shall be considered relatives to the same extent such relatives would be included in this Section, as if the employee and domestic partner were married. The Board of Directors shall meet regularly and fulfill all of the duties under applicable Washington State law and federal law.

The Board of Directors shall maintain a formal conflict of interest policy for Board members that complies with the applicable provisions of the Internal Revenue Code 501(c)(3) status, and addresses issues regarding gifts, financial gain, and improper use of position.

The Contract shall be reviewed and approved for Agency signature by the Agency's Board of Directors.

Each amendment to this Contract must be approved by the Agency's Board of Directors.

A. **Interests of Agency Management and Agency Board:**

The following shall be disallowed and shall be considered a conflict of interest without prior disclosure and approval of the County:

1. The Agency shall not employ an individual who is related to a director or assistant director of the Agency or an Agency Board member, either as an employee, contractor or through a corporation. This provision shall not apply when the total compensation paid to the individual is less than \$500 per annum.
2. The Agency shall not acquire or rent real and/or personal property owned or rented by either:
 - a. an employee or Board member of the Agency;
 - b. a relative of an employee or Board member of the Agency; or
 - c. a corporation in which an employee or Board member of the Agency, or a relative of such a person, has ownership.

B. Failure to comply with any provision of this Section XX shall constitute a material breach of this Contract.

XXI. MANAGING DIRECTOR OF AGENCY

The managing director of the Agency shall be an attorney licensed to practice law in the State of Washington. The managing director shall be a salaried employee of the Agency, subject to the authority and control of the Board of Directors of the Agency. The managing director of the Agency shall be responsible for receiving funds into program accounts or issuing financial documents, checks, or other instruments of payment for program costs provided pursuant to this Contract.

XXII. POLITICAL ACTIVITY PROHIBITED

No funds, materials, property, or services provided directly or indirectly under this Contract shall be used for any partisan political activity or to further the election or defeat of any candidate for public office.

XXIII. EQUIPMENT PURCHASE, MAINTENANCE, AND OWNERSHIP

- A. The Agency agrees that any equipment purchased with Contract funds at a cost of \$5,000 per item or more, and identified in an exhibit as reimbursable, is upon its purchase or receipt the property of the County, and/or federal, and/or state government as specified in the exhibit.
- B. The Agency shall be responsible for all such equipment, including the proper care and maintenance.
- C. The Agency shall ensure that all such equipment will be returned to the appropriate government agency, whether federal, state or County, upon written request of the County.

- D. The Agency shall admit County staff to the Agency's premises for the purpose of marking such equipment with appropriate government property tags.
- E. The Agency shall establish and maintain inventory records and transaction documents (purchase requisitions, packing slips, invoices, receipts) of equipment purchased with Contract identified funds.

XXIV. NOTICES

Whenever this Contract provides for notice to be provided by one party to another, such notice shall be:

- A. In writing; and

Directed to the managing director of the Agency, the President of the Board of Directors of the Agency, The Office of the Public Defender, and the director of the Department of Community and Human Services.

- B. Any due date within which a party must take some action shall be computed according to CR 6(a). If notice is provided by US Post, CR 5(b)(2)(A) shall apply to determine the date of service.

XXV. PROPRIETARY RIGHTS

The parties to this Contract hereby mutually agree that if any patentable or copyrightable material or article is the product of work performed for the County as described herein, all rights accruing from such material or article shall be the sole property of the Agency. The Agency agrees to and does hereby grant to the County, irrevocable, nonexclusive, and royalty-free license to use, according to law, any material or article and use any method that may be developed as part of the work under this Contract.

The foregoing products license shall not apply to existing training materials, consulting aids, checklists, and other materials and documents of the Agency which are used in the performance of this Contract.

XXVI. CONTRACT AMENDMENTS

Either party may request changes to this Contract. Proposed changes which are mutually agreed upon shall be incorporated by written amendments to this Contract.

XXVII. KING COUNTY RECYCLED PRODUCT PROCUREMENT POLICY

The Agency shall use recycled paper for the production of all printed and photocopied documents related to the fulfillment of this Contract and shall ensure that, whenever possible, the cover page of each document printed on recycled paper bears an imprint identifying it as recycled paper. All Court document production shall be covered by Court rules.

If the cost of recycled paper is more than 15 percent higher than the cost of non-recycled paper, the Agency may notify the Contract Administrator, who may waive the recycled paper requirement.

The Agency shall use both sides of paper sheets for copying and printing and shall use recycled/recyclable products wherever practical in the fulfillment of this Contract.

XXVIII. SERVICES PROVIDED IN ACCORDANCE WITH LAW AND RULE AND REGULATION

The Agency and any subcontractor agree to abide by all of the laws of the State of Washington that are applicable to their business and the substance of the legal services that are the subject of this Contract. The Agency and any subcontractors also agree to abide by all Rules of Professional Conduct governing attorney conduct and to abide by the requirements of the attorney-client privilege, as defined by Washington statutory law and common law.

In the event that there is a conflict between any of the language contained in any exhibit or attachment to this Contract, the language in the Contract shall have control over the language contained in the exhibit or the attachment, unless the parties affirmatively agree in writing to the contrary.

XXIX. CONFIDENTIALITY

The Agency agrees that information, records, and data collected in connection with this Contract shall be protected from unauthorized disclosure in accordance with applicable common law, state and federal law, including but not limited to attorney-client privilege. The County agrees that the King County Office of The Public Defender shall protect any information received from the Agency from unauthorized disclosure in accordance with applicable common law, state and federal law, including but not limited to attorney-client privilege.

The County, through the Office of The Public Defender, shall abide by any applicable law of privilege in monitoring the Agency's performance under this Contract.

XXX. COMPLIANCE WITH THE HEALTH INSURANCE PORTABILITY ACCOUNTABILITY ACT OF 1996

Terms used in this Section shall have the same meaning as those terms in the Privacy Rule, 45 CFR Parts 160 and 164.

A. Obligations and Activities of the Agency

1. The Agency agrees not to acquire, use, or disclose protected health information other than as permitted or required by law.
2. The Agency agrees to implement administrative, physical, and technical safeguards that reasonably and appropriately protect the confidentiality, integrity, and availability of the protected health information that it creates, receives, maintains, or transmits on behalf of the County as required by CFR Title 45, Section 164, Subpart C.
3. The Agency agrees to mitigate, to the extent practicable, any harmful effect that is known to the Agency of a use or disclosure of protected health information by the Agency in violation of the requirements of this Contract.
4. The Agency agrees to report in writing all unauthorized or otherwise improper disclosures of a client's protected health information or security incident to the County by the Agency within two days of the Agency knowledge of such event.
5. The Agency agrees to ensure that any agent, including a subcontractor, to whom it provides protected health information received from, or created or received by the Agency on behalf of the County, agrees to the same restrictions

and conditions that apply through this Contract to the Agency with respect to such information.

6. The Agency agrees to make available protected health information in accordance with 45 CFR § 164.524.
7. The Agency agrees to make available protected health information for amendment and incorporate any amendments to protected health information in accordance with 45 CFR § 164.526.
8. The Agency agrees to make internal practices, books, and records, including policies and procedures and protected health information, relating to the use and disclosure of protected health information received from, or created or received by the Agency on behalf of King County, available to the Secretary, in a reasonable time and manner for purposes of the Secretary determining King County's compliance with the Privacy Rule.
9. The Agency agrees to make available the information required to provide an accounting of disclosures in accordance with 45 CFR § 164.528.

B. Permitted Uses and Disclosures by Business Associate

The Agency may use or disclose protected health information to perform functions, activities, or services for, or on behalf of, King County as specified in this Contract, provided that such use or disclosure would not violate the Privacy Rule if done by King County or the minimum necessary policies and procedures of King County.

C. Effect of Termination

1. Except as provided in Paragraph C.2. of this Section, upon termination of this Contract, for any reason, the Agency shall return or destroy all protected health information received from King County, or created or received by the Agency on behalf of King County. This provision shall apply to protected health information that is in the possession of subcontractors or agents of the Agency. The Agency shall retain no copies of the protected health information.
2. In the event the Agency determines that returning or destroying the protected health information is infeasible, the Agency shall provide to King County notification of the conditions that make return or destruction infeasible. Upon notification that return or destruction of protected health information is infeasible, the Agency shall extend the protections of the Contract to such protected health information and limit further uses and disclosure of such protected health information to those purposes that make the return or destruction infeasible, for so long as the Agency maintains such protected health information.

XXXI. NO THIRD PARTY BENEFICIARIES

Except for the Parties to whom this Contract is assigned in compliance with the terms of this Contract, there are no third party beneficiaries to this Contract, and this Contract shall not impart any rights enforceable by any person or entity that is not a Party hereto.

XXXII. ENTIRE CONTRACT/WAIVER OF DEFAULT

The parties agree that this Contract is the complete understanding of the terms hereto and any oral or written representations or understandings not incorporated herein are excluded. Both parties recognize that time is of the essence in the performance of the provisions of this Contract. Waiver of any default shall not be deemed to be a waiver of any other or subsequent breach and shall not be construed to be a modification of the terms of the Contract unless stated to be such through written approval by the County, a copy of which shall be attached to the original copy of this Contract.

XXXIII. GOVERNING LAW/SEVERABILITY/CONSTRUCTION

This Contract shall be governed by Washington law. If any one or more provisions of this Contract shall be held by any court to be invalid or unenforceable, such invalidity or unenforceability shall not adversely affect the validity or enforceability of any other part of this Contract. This Contract shall not be construed for nor against any party, regardless of its drafter.

KING COUNTY

King County Executive

FOR

Signature

Date 12/27/07

David K. Chapman
NAME (Please type or print)

12-18-07
Date

Approved as to Form:

OFFICE OF THE KING COUNTY
SPECIAL DEPUTY PROSECUTOR

Date: 11/29/07

EXHIBIT I

Certificate of Insurance/Endorsements

ACORD CERTIFICATE OF LIABILITY INSURANCE		OP ID RN A804000	DATE (MM/DD/YYYY) 12/19/07
PRODUCER Degginger McIntosh & Assoc. Box 1400 77 Harbour Pointe SW Mukilteo WA 98275 Phone: 425-740-5200 Fax: 425-740-5201		THIS CERTIFICATE IS ISSUED AS A MATTER OF INFORMATION ONLY AND CONFERS NO RIGHTS UPON THE CERTIFICATE HOLDER. THIS CERTIFICATE DOES NOT AMEND, EXTEND OR ALTER THE COVERAGE AFFORDED BY THE POLICIES BELOW.	
INSURED		INSURERS AFFORDING COVERAGE	NAIC #
Associated Counsel for The Accused 110 Prefontaine Pl. S, Ste. 200 Seattle WA 98104-2674		INSURER A: Mutual of Enumclaw Ins. Co.	
		INSURER B: Columbia Casualty Company	
		INSURER C:	
		INSURER D:	
		INSURER E:	

COVERAGES

THE POLICIES OF INSURANCE LISTED BELOW HAVE BEEN ISSUED TO THE INSURED NAMED ABOVE FOR THE POLICY PERIOD INDICATED. NOTWITHSTANDING ANY REQUIREMENT, TERM OR CONDITION OF ANY CONTRACT OR OTHER DOCUMENT WITH RESPECT TO WHICH THIS CERTIFICATE MAY BE ISSUED OR MAY PERTAIN, THE INSURANCE AFFORDED BY THE POLICIES DESCRIBED HEREIN IS SUBJECT TO ALL THE TERMS, EXCLUSIONS AND CONDITIONS OF SUCH POLICIES. AGGREGATE LIMITS SHOWN MAY HAVE BEEN REDUCED BY PAID CLAIMS.

INSR	ADD'D	TYPE OF INSURANCE	POLICY NUMBER	POLICY EFFECTIVE DATE (MM/DD/YY)	POLICY EXPIRATION DATE (MM/DD/YY)	LIMITS
A	X	GENERAL LIABILITY <input checked="" type="checkbox"/> COMMERCIAL GENERAL LIABILITY <input type="checkbox"/> CLAIMS MADE <input checked="" type="checkbox"/> OCCUR GEN'L AGGREGATE LIMIT APPLIES PER: <input type="checkbox"/> POLICY <input checked="" type="checkbox"/> PROJECT <input type="checkbox"/> LOC	B048475	01/01/08	01/01/09	EACH OCCURRENCE \$1,000,000 DAMAGE TO RENTED PREMISES (Ea occurrence) \$100,000 MED EXP (Any one person) \$10,000 PERSONAL & ADV INJURY \$1,000,000 GENERAL AGGREGATE \$2,000,000 PRODUCTS - COMPPOP AGG \$2,000,000
A		AUTOMOBILE LIABILITY <input type="checkbox"/> ANY AUTO <input type="checkbox"/> ALL OWNED AUTOS <input type="checkbox"/> SCHEDULED AUTOS <input checked="" type="checkbox"/> HIRED AUTOS <input checked="" type="checkbox"/> NON-OWNED AUTOS	B048475 B048475	01/01/08 01/01/08	01/01/09 01/01/09	COMBINED SINGLE LIMIT (Ea accident) \$1,000,000 BODILY INJURY (Per person) \$ BODILY INJURY (Per accident) \$ PROPERTY DAMAGE (Per accident) \$ AUTO ONLY - EA ACCIDENT \$ OTHER THAN AUTO ONLY: EA ACC \$ AGG \$
		GARAGE LIABILITY <input type="checkbox"/> ANY AUTO				AUTO ONLY - EA ACCIDENT \$ OTHER THAN AUTO ONLY: EA ACC \$ AGG \$
A		EXCESS/UMBRELLA LIABILITY <input checked="" type="checkbox"/> OCCUR <input type="checkbox"/> CLAIMS MADE DEDUCTIBLE <input checked="" type="checkbox"/> RETENTION \$10,000	NC53644	01/01/08	01/01/09	EACH OCCURRENCE \$1,000,000 AGGREGATE \$1,000,000 \$ \$ \$
A		WORKERS COMPENSATION AND EMPLOYERS' LIABILITY ANY PROPRIETOR/PARTNER/EXECUTIVE OFFICER/MEMBER EXCLUDED? If yes, describe under SPECIAL PROVISIONS below OTHER	B048475 WA STOP GAP	01/01/08	01/01/09	WC STATUTORY LIMITS <input checked="" type="checkbox"/> OTHER E.L. EACH ACCIDENT \$1,000,000 E.L. DISEASE - EA EMPLOYEE \$1,000,000 E.L. DISEASE - POLICY LIMIT \$1,000,000
B		Professional Liab Deduct \$1,000	NLA800536	01/01/08	01/01/09	Each Clm \$2,000,000 Aggregate \$2,000,000

DESCRIPTION OF OPERATIONS / LOCATIONS / VEHICLES / EXCLUSIONS ADDED BY ENDORSEMENT / SPECIAL PROVISIONS
 King County, it officers, officials, employees & agents are included as Additional Insured per form BP0448 (0197) with respects to any & all operations of Named Insured.

CERTIFICATE HOLDER

CANCELLATION

KING008 King County, Office of the Public Defender Walthew Bldg. 123 3rd Avenue S, Floor 4 Seattle WA 98104-2696	SHOULD ANY OF THE ABOVE DESCRIBED POLICIES BE CANCELLED BEFORE THE EXPIRATION DATE THEREOF, THE ISSUING INSURER WILL ENDEAVOR TO MAIL 30 DAYS WRITTEN NOTICE TO THE CERTIFICATE HOLDER NAMED TO THE LEFT, BUT FAILURE TO DO SO SHALL IMPOSE NO OBLIGATION OR LIABILITY OF ANY KIND UPON THE INSURER, ITS AGENTS OR REPRESENTATIVES. AUTHORIZED REPRESENTATIVE Kenneth McIntosh
--	--

ACORD 25 (2001/08)

© ACORD CORPORATION 1988

ACORD CERTIFICATE OF LIABILITY INSURANCE

OP ID RW
AS04000

DATE (MM/DD/YYYY)
12/19/07

PRODUCER
Degginger McIntosh & Assoc.*
PO Box 1400
3977 Harbour Pointe SW
Mukilteo WA 98275
Phone: 425-740-5200 Fax: 425-740-5201

THIS CERTIFICATE IS ISSUED AS A MATTER OF INFORMATION ONLY AND CONFERS NO RIGHTS UPON THE CERTIFICATE HOLDER. THIS CERTIFICATE DOES NOT AMEND, EXTEND OR ALTER THE COVERAGE AFFORDED BY THE POLICIES BELOW.

INSURED

Associated Counsel for
The Accused
110 Prefontaine Pl. S, Ste. 200
Seattle WA 98104-2674

INSURERS AFFORDING COVERAGE

INSURER A: Mutual of Emmaus Ins. Co.
INSURER B: Columbia Casualty Company
INSURER C:
INSURER D:
INSURER E:

NAIC #

COVERAGES

THE POLICIES OF INSURANCE LISTED BELOW HAVE BEEN ISSUED TO THE INSURED NAMED ABOVE FOR THE POLICY PERIOD INDICATED. NOTWITHSTANDING ANY REQUIREMENT, TERM OR CONDITION OF ANY CONTRACT OR OTHER DOCUMENT WITH RESPECT TO WHICH THIS CERTIFICATE MAY BE ISSUED OR MAY PERTAIN, THE INSURANCE AFFORDED BY THE POLICIES DESCRIBED HEREIN IS SUBJECT TO ALL THE TERMS, EXCLUSIONS AND CONDITIONS OF SUCH POLICIES. AGGREGATE LIMITS SHOWN MAY HAVE BEEN REDUCED BY PAID CLAIMS.

INSR	ADD'L	TR	INSR	TYPE OF INSURANCE	POLICY NUMBER	POLICY EFFECTIVE DATE (MM/DD/YY)	POLICY EXPIRATION DATE (MM/DD/YY)	LIMITS
A	X			GENERAL LIABILITY <input checked="" type="checkbox"/> COMMERCIAL GENERAL LIABILITY <input type="checkbox"/> CLAIMS MADE <input checked="" type="checkbox"/> OCCUR GEN'L AGGREGATE LIMIT APPLIES PER: <input type="checkbox"/> POLICY <input checked="" type="checkbox"/> PRO-JECT <input type="checkbox"/> LOC	B048475	01/01/08	01/01/09	EACH OCCURRENCE \$ 1,000,000 DAMAGE TO RENTED PREMISES (Ea occurrence) \$ 100,000 MED EXP (Any one person) \$ 10,000 PERSONAL & ADV INJURY \$ 1,000,000 GENERAL AGGREGATE \$ 2,000,000 PRODUCTS - COMP/OP AGG \$ 2,000,000
A				AUTOMOBILE LIABILITY <input type="checkbox"/> ANY AUTO <input type="checkbox"/> ALL OWNED AUTOS <input type="checkbox"/> SCHEDULED AUTOS <input checked="" type="checkbox"/> HIRED AUTOS <input checked="" type="checkbox"/> NON-OWNED AUTOS	B048475 B048475	01/01/08 01/01/08	01/01/09 01/01/09	COMBINED SINGLE LIMIT (Ea accident) \$ 1,000,000 BODILY INJURY (Per person) \$ BODILY INJURY (Per accident) \$ PROPERTY DAMAGE (Per accident) \$ AUTO ONLY - EA ACCIDENT \$ OTHER THAN AUTO ONLY: EA ACC \$ AGG \$
				GARAGE LIABILITY <input type="checkbox"/> ANY AUTO				AUTO ONLY - EA ACCIDENT \$ OTHER THAN AUTO ONLY: EA ACC \$ AGG \$
A				EXCESS/UMBRELLA LIABILITY <input checked="" type="checkbox"/> OCCUR <input type="checkbox"/> CLAIMS MADE DEDUCTIBLE <input checked="" type="checkbox"/> RETENTION \$10,000	NC53644	01/01/08	01/01/09	EACH OCCURRENCE \$ 1,000,000 AGGREGATE \$ 1,000,000 \$ \$ \$
A				WORKERS COMPENSATION AND EMPLOYERS' LIABILITY ANY PROPRIETOR/PARTNER/EXECUTIVE OFFICER/MEMBER EXCLUDED? If yes, describe under SPECIAL PROVISIONS below OTHER	B048475 WA STOP GAP	01/01/08	01/01/09	WC STATUTORY LIMITS <input checked="" type="checkbox"/> OTHER \$ E.L. EACH ACCIDENT \$ 1,000,000 E.L. DISEASE - EA EMPLOYEE \$ 1,000,000 E.L. DISEASE - POLICY LIMIT \$ 1,000,000
B				Professional Liab Deduct \$1,000	NLA800536	01/01/08	01/01/09	Each Cln \$2,000,000 Aggregate \$2,000,000

DESCRIPTION OF OPERATIONS / LOCATIONS / VEHICLES / EXCLUSIONS ADDED BY ENDORSEMENT / SPECIAL PROVISIONS
 King County, it officers, officials, employees & agents are included as Additional Insured per form BP0448(0197) with respects to any & all operations of Named Insured.

CERTIFICATE HOLDER

KING008

King County, Office of the
Public Defender
Walthev Bldg.
123 3rd Avenue S, Floor 4
Seattle WA 98104-2696

CANCELLATION

SHOULD ANY OF THE ABOVE DESCRIBED POLICIES BE CANCELLED BEFORE THE EXPIRATION DATE THEREOF, THE ISSUING INSURER WILL ENDEAVOR TO MAIL 30 DAYS WRITTEN NOTICE TO THE CERTIFICATE HOLDER NAMED TO THE LEFT, BUT FAILURE TO DO SO SHALL IMPOSE NO OBLIGATION OR LIABILITY OF ANY KIND UPON THE INSURER, ITS AGENTS OR REPRESENTATIVES.

AUTHORIZED REPRESENTATIVE
Kenneth McIntosh

ACORD 25 (2001/08)

© ACORD CORPORATION 1988

ACORD CERTIFICATE OF LIABILITY INSURANCE

OP ID R#
AS04000

DATE (MM/DD/YYYY)
12/19/07

PRODUCER
Degginger McIntosh & Assoc.
PO Box 1400
3977 Harbour Pointe SW
Mukilteo WA 98275
Phone: 425-740-5200 Fax: 425-740-5201

THIS CERTIFICATE IS ISSUED AS A MATTER OF INFORMATION ONLY AND CONFERS NO RIGHTS UPON THE CERTIFICATE HOLDER. THIS CERTIFICATE DOES NOT AMEND, EXTEND OR ALTER THE COVERAGE AFFORDED BY THE POLICIES BELOW.

INSURED

Associated Counsel for
The Accused
110 Prefontaine Pl. S, Ste. 200
Seattle WA 98104-2674

INSURERS AFFORDING COVERAGE	NAIC #
INSURER A: Mutual of Knoxville Ins. Co.	
INSURER B: Columbia Casualty Company	
INSURER C:	
INSURER D:	
INSURER E:	

COVERAGES

THE POLICIES OF INSURANCE LISTED BELOW HAVE BEEN ISSUED TO THE INSURED NAMED ABOVE FOR THE POLICY PERIOD INDICATED. NOTWITHSTANDING ANY REQUIREMENT, TERM OR CONDITION OF ANY CONTRACT OR OTHER DOCUMENT WITH RESPECT TO WHICH THIS CERTIFICATE MAY BE ISSUED OR MAY PERTAIN, THE INSURANCE AFFORDED BY THE POLICIES DESCRIBED HEREIN IS SUBJECT TO ALL THE TERMS, EXCLUSIONS AND CONDITIONS OF SUCH POLICIES. AGGREGATE LIMITS SHOWN MAY HAVE BEEN REDUCED BY PAID CLAIMS.

INSR ADD'L LTR	INSRD	TYPE OF INSURANCE	POLICY NUMBER	POLICY EFFECTIVE DATE (MM/DD/YY)	POLICY EXPIRATION DATE (MM/DD/YY)	LIMITS
A	X	GENERAL LIABILITY <input checked="" type="checkbox"/> COMMERCIAL GENERAL LIABILITY <input type="checkbox"/> CLAIMS MADE <input checked="" type="checkbox"/> OCCUR GEN'L AGGREGATE LIMIT APPLIES PER: <input type="checkbox"/> POLICY <input checked="" type="checkbox"/> PRO-JECT <input type="checkbox"/> LOC	B048475	01/01/08	01/01/09	EACH OCCURRENCE \$ 1,000,000 DAMAGE TO RENTED PREMISES (Ea occurrence) \$ 100,000 MED EXP (Any one person) \$ 10,000 PERSONAL & ADY INJURY \$ 1,000,000 GENERAL AGGREGATE \$ 2,000,000 PRODUCTS - COMPROP AGG \$ 2,000,000
A		AUTOMOBILE LIABILITY <input type="checkbox"/> ANY AUTO <input type="checkbox"/> ALL OWNED AUTOS <input type="checkbox"/> SCHEDULED AUTOS <input checked="" type="checkbox"/> HIRED AUTOS <input checked="" type="checkbox"/> NON-OWNED AUTOS	B048475 B048475	01/01/08 01/01/08	01/01/09 01/01/09	COMBINED SINGLE LIMIT (Ea accident) \$ 1,000,000 BODILY INJURY (Per person) \$ BODILY INJURY (Per accident) \$ PROPERTY DAMAGE (Per accident) \$ AUTO ONLY - EA ACCIDENT \$ OTHER THAN AUTO ONLY: EA ACC \$ AGG \$
		GARAGE LIABILITY <input type="checkbox"/> ANY AUTO				AUTO ONLY - EA ACCIDENT \$ OTHER THAN AUTO ONLY: EA ACC \$ AGG \$
A		EXCESS/UMBRELLA LIABILITY <input checked="" type="checkbox"/> OCCUR <input type="checkbox"/> CLAIMS MADE DEDUCTIBLE <input checked="" type="checkbox"/> RETENTION \$10,000	NC53644	01/01/08	01/01/09	EACH OCCURRENCE \$ 1,000,000 AGGREGATE \$ 1,000,000 \$ \$ \$
A		WORKERS COMPENSATION AND EMPLOYERS' LIABILITY ANY PROPRIETOR/PARTNER/EXECUTIVE OFFICER/MEMBER EXCLUDED? If yes, describe under SPECIAL PROVISIONS below OTHER	B048475 WA STOP GAP	01/01/08	01/01/09	<input type="checkbox"/> WC-STATU-TORY LIMITS <input checked="" type="checkbox"/> OTH-ER E.L. EACH ACCIDENT \$ 1,000,000 E.L. DISEASE - EA EMPLOYEE \$ 1,000,000 E.L. DISEASE - POLICY LIMIT \$ 1,000,000
B		Professional Liab Deduct \$1,000	NLA800536	01/01/08	01/01/09	Each Clm \$2,000,000 Aggregate \$2,000,000

DESCRIPTION OF OPERATIONS / LOCATIONS / VEHICLES / EXCLUSIONS ADDED BY ENDORSEMENT / SPECIAL PROVISIONS
 King County, it officers, officials, employees & agents are included as Additional Insured per form BP0448 (0197) with respects to any & all operations of Named Insured.

CERTIFICATE HOLDER	CANCELLATION
KING008 King County, Office of the Public Defender Walthew Bldg. 123 3rd Avenue S, Floor 4 Seattle WA 98104-2696	SHOULD ANY OF THE ABOVE DESCRIBED POLICIES BE CANCELLED BEFORE THE EXPIRATION DATE THEREOF, THE ISSUING INSURER WILL ENDEAVOR TO MAIL 30 DAYS WRITTEN NOTICE TO THE CERTIFICATE HOLDER NAMED TO THE LEFT, BUT FAILURE TO DO SO SHALL IMPOSE NO OBLIGATION OR LIABILITY OF ANY KIND UPON THE INSURER, ITS AGENTS OR REPRESENTATIVES. AUTHORIZED REPRESENTATIVE Kenneth McIntosh



EXHIBIT II

Personnel Inventory Report

Legal name of business ASSOCIATED COUNSEL FOR THE ACCUSED Contract No: _____
 dba (if applicable) _____ Telephone No: 206-624-8105
 Street address 110 PREFONTAINE PL S, SUITE 200 City SEATTLE State WA Zip Code 98104
 Submitted by: ANNE DOLAN Title CONTROLLER Date 18 DEC 2007

Do you have any employees? No ___ Yes Sole Owner/Operator No Yes ___

If yes, list on the Employment Data Chart below the total number of employees for all businesses located within each location listed below. Indicate which locale (1,2,3) report covers. This report is for Payroll Period ending (Month/Day/Year): 12/21/07 and covers the following locale: (Check only one box)

1. Business located within King County 3. ___ Business located with U. S.
 2. ___ Businesses located within WA State 4. ___ Other (specify) _____

Do any of your employees belong to a union and/or do you use an employee referral agency? No ___ Yes ___

If yes, list the unions and/or employee referral agencies with whom you have agreements: _____ If you expect to do more than \$10,000 worth of public work (construction) or, more than \$25,000 worth of business with King County, the unions or employee referral agencies must submit a statement of compliance with King County Code Chapter 12.16.

Job Categories	Whites		African Americans		Asians		Native Americans		Hispanics		Disabled		Minority Subtotal		Disabled Subtotal	
	M	F	M	F	M	F	M	F	M	F	M	F	M	F	M	F
Managerial	5	4		2	1			1					1	3		
Professional	24	41		4	5	3			2	2			7	9		
Technical/Paralegal	1	2		1										1		
Clerical	3	6		7	1						1		1	7	1	
Investigator	2	6	1	2				1	1	2			2	5		
Social Worker	3	4														
Labor																
On-Job Trainees																
Apprentice																
Skilled Craft Total*																
Total	38	63	1	16	7	3		2	3	4	1		11	25	1	

* Journey worker: List by classification on reverse, e.g., carpenter, plumber, etc.

Total number of employees reported above: 137 If no employees, write "0."



EXHIBIT III

Affidavit and Certificate of Compliance

with King County Code Chapter 12.16, Discrimination and Affirmative Action
in Employment by Contractors, Subcontractors and Vendors

The undersigned, being first duly sworn, on oath states, s/he is authorized by the Contractor, and on the Contractor's behalf, affirms and certifies as follows:

Definitions: "Contractor" shall mean any contractor, vendor or consultant who supplies goods and/or services. "Contract" shall mean any contract, purchase order or agreement with King County Government, hereinafter called the County.

A. Contractor recognizes that discrimination in employment is prohibited by federal, state and local laws. Contractor recognizes that in addition to refraining from discrimination, affirmative action is required to provide equal employment opportunity. Contractor further recognizes that this Affidavit establishes minimum requirements for affirmative action and fair employment practices and implements the basic nondiscrimination provisions of the general contract specifications as applied to service, consultant, and vendor contracts exceeding \$25,000, or public work contracts exceeding \$10,000. Contractor herein agrees that this Affidavit is incorporated as an addendum to its general contract, and recognizes that failure to comply with these requirements may constitute grounds for application of sanctions as set forth in the general specifications, King County Code Chapter 12.16 ("Chapter") and this Affidavit. PROVIDED FURTHER, that in lieu of this Affidavit, the Executive may accept a statement pledging adherence to an existing contractor affirmative action plan where the provisions of the plan are found by the Executive to substantially fulfill the requirements of the Chapter.

B. Contractor shall give notice to their supervisors and employees of the requirements for affirmative action to be undertaken prior to the commencement of work.

C. This person has been designated to represent the Contractor and to be responsible for securing compliance with and for reporting on the affirmative actions taken:

David E. Chapman

D. Contractor will cooperate fully with the BD and Contract Compliance Section and appropriate County agents while making every reasonable "good faith" effort to comply with the affirmative action and nondiscrimination requirements set forth in this Affidavit and in King County Code Chapter 12.16.

E. Reports: The Contractor agrees to complete and submit as required such additional reports and records that may be necessary to determine compliance with the Affidavit and to confer with the County Compliance Officer at such times as the County shall deem necessary. The information required by the Chapter includes but is not limited to the following reports and records:

1. **Personnel Inventory Report:** This report shall include a breakdown of the employer workforce showing race, sex and handicapped and other minority data.
2. **Monthly EEO Report:** This report shall apply to construction contractors and subcontractors and shall provide the number of hours of employment for all employees, including minority, women and disabled employees by craft and category.
3. **Statement from Union or Worker Referral Agency:** This statement affirms that the signee's organization has no practices and policies which discriminate on the basis of race,

color, creed, religion, sex, age, marital status, sexual orientation, nationality or the presence of sensory, mental or physical disability.

The information required in this section shall be submitted on forms provided by the County unless otherwise specified.

F. **Subcontractors:** For public works projects and contracts over ten thousand dollars (\$10,000) the prime contractor shall be required to submit to the County, along with its qualifying documents under the Chapter, employment profiles, Affidavits and Certificates of Compliance, Reports and Union Statements from its subcontractors in the same manner as these are required of the prime contractor. Reporting requirements of the prime contractor during the contract period will apply equally to all subcontractors.

G. **Employment Goals for Minorities, Women and Persons with Disabilities:** No specific levels of utilization of minorities and women in the workforce of the Contractor shall be required, and the Contractor is not required to grant any preferential treatment on the basis of race, sex, color, ethnicity or national origin in its employment practices. Notwithstanding the foregoing, any affirmative action requirements set forth in any federal regulations, statutes or rules included or referenced in the contract documents shall continue to apply.

H. **Affirmative Action Measures:** Contractor agrees to implement and/or maintain reasonable good faith efforts to comply with King County Code Chapter 12.16. The evaluation of a contractor's compliance with the Chapter shall be based upon the contractor's effort to achieve maximum results from its affirmative action measures. The Contractor shall document these efforts and shall implement affirmative action steps at least as extensive as the following:

1. **Policy Dissemination:** Internal and external dissemination of the contractor's equal employment opportunity policy; posting of nondiscrimination policies and of the requirement of the Chapter on bulletin boards clearly visible to all employees; notification to each subcontractor, labor union or representative of workers with which there is a collective bargaining agreement or other contract, subcontract, or understanding of the contractor's commitments under the Chapter. Inclusion of the equal opportunity policy in advertising in the news media and elsewhere.
2. **Recruiting:** Adopt and implement recruitment procedures designed to increase the representation of women, minorities and persons with disabilities in the pool of applicants for employment: including, but not limited to establishing and maintaining a current list of minority, women and disabled recruitment sources, providing these sources written notification of employment opportunities and advertising vacant positions in newspapers and periodicals which have minority, women and/or disabled readership.
3. **Self-Assessment and Test Validation:** Review of all employment policies and procedures, including tests, recruitment, hiring and training practices and policies, performance evaluations, seniority policies and practices, job classifications and job assignments to assure that they do not discriminate against, or have a discriminatory impact on, minorities, women and persons with disabilities and validate all tests and

other selection requirements where there is an obligation to do so under state or federal law.

4. **Record Referrals:** Maintain a current file of applications of each minority, women and persons with disabilities who are applicants or referrals for employment indicating what action was taken with respect to each such individual and the reasons therefor. Contact these people when an opening exists for which they may be qualified. Names may be removed from the file after twelve months have elapsed from their last application or referral.
5. **Notice to Unions:** Provide notice to labor unions of the contractor's nondiscrimination and affirmative action obligations pursuant to King County Code Chapter 12.16. Contractors shall also notify the BD and Contract Compliance Section if labor unions fail to comply with the nondiscrimination or affirmative provisions
6. **Supervisors:** Ensure that all supervisory personnel understand and are directed to adhere to and implement the non-discrimination and affirmative action obligations of the contractor under King County Code Chapter 12.16. Such direction shall include, but not be limited to, adherence to, and achievement of, affirmative action policies in performance appraisals of supervisory personnel.
7. **Employee Training:** When reasonable, develop on-the-job training opportunities which expressly include minorities, women, and persons with disabilities and sponsor and/or utilize, training/educational opportunities for the advancement of women, minorities and persons with disabilities employed by the contractor, subject to acceptance by the county.
8. **Responsible Person:** Designate an employee who shall have the responsibility for implementation of the Contractor's affirmative action measures.
9. **Progress Reporting:** Prepare as part of the affirmative action plan an analysis and report on the progress made toward eliminating the underrepresentation of minorities, women, and persons with disabilities in the contractor's workforce on

an annual basis.

- I. During the performance of this Contract, neither the Contractor nor any party subcontracting under the authority of this Contract shall discriminate nor tolerate harassment on the basis of race, color, sex, religion, nationality, creed, marital status, sexual orientation, age, or the presence of any sensory, mental or physical disability in the employment or application for employment or in the administration or delivery of services or any other benefits under this Contract.
- J. Contractor agrees to provide reasonable access upon request to the premises of all places of business and employment, relative to work undertaken in this Contract, and to records, files, information and employees in connection therewith, to the BD and Contract Compliance Section or agent for purposes of reviewing compliance with the provisions of this Affidavit and agrees to cooperate in any compliance review.
- K. Should the BD and Contract Compliance Section find, upon complaint investigation or review, the Contractor not to be in good faith compliance with the provisions contained in this Affidavit, it shall notify the County and Contractor in writing of the finding fully describing the basis of non-compliance. Contractor may request withdrawal of such notice of noncompliance at such time as the compliance office has notified in writing the Contractor and the County that the noncompliance has been resolved.
- L. The Contractor agrees that any violation of any term of this Affidavit, including reporting requirements, shall be deemed a violation of King County Code Chapter 12.16. Any such violation shall be further deemed a breach of a material provision of the Contract between the County and the Contractor. Such breach may be grounds for implementation of any sanctions provided for in the Chapter, including but not limited to, cancellation, termination or suspension, in whole or part, of the Contractor by the County; liquidated damages; or disqualification of the Contractor PROVIDED, that the implementation of any sanctions is subject to the notice and hearing provisions of King County Code Chapter 12.16.110.

Contractor: Associated Counsel for the Accused 110 P. Montrose Pl. S #200 Seattle WA 98104
 Company Name Street Address City State Zip

I have read and understood the foregoing, and am authorized on behalf of the Contractor to agree to the terms and conditions of this and Affidavit and Certificate of Compliance and therefore, execute the same.

Authorized Signer: David E. Chapman Managing Director 206-624-8105 x237 [Signature]
 Name (type or print) Title Phone Signature

VALID ONLY IF NOTARIZED

SUBSCRIBED AND SWORN TO BEFOR ME THIS 18th DAY OF November, 2008.

Carol Greengard Nolan
 Notary Public in and of the state of Washington

Residing at: Seattle, WA.

EXHIBIT IV

504/ADA SELF-EVALUATION AND ASSURANCE OF COMPLIANCE

Instructions

504/ADA Self-Evaluation Questionnaire Form

This form will help you evaluate your organization's or firm's programs and services, employment, and facilities to ensure they are accessible to people with disabilities. Complete the 504/ADA Self-Evaluation Questionnaire and keep it on file at your office. Do not return the questionnaire with your contract.

"Quick Look" Barriers Checklist

Note: If the business is a construction company, this form pertains only to the main office, not the construction sites. Firms that provide services outside their office do not need to write a corrective action plan for physical accessibility as long as these services are provided in an accessible location for people with disabilities who cannot access the office. However, physical access must also be reviewed in light of hiring an individual with a disability or accommodating a current employee who becomes disabled.

504/ADA Assurance of Compliance Form

All contractors must complete this form, as required by King County Code 12.16.060. Governmental agencies and contracts for the direct purchase of goods are exempt.

- **Complete this form.** If your organization or firm is out of compliance with any of the 504/ADA requirements, indicate on the 504/ADA Disability Assurance of Compliance form the corrective actions that will be taken to achieve compliance and the date these actions will be completed.
- **Sign the Assurance of Compliance form and send the original back with your contract.** Keep a copy of the form on file in your office for use during on-site reviews. You will be notified at least one week in advance of any scheduled review. (Note: This form may be used as an exhibit with other King County contracts for two years from the date the form is completed.)

If you have questions regarding this process, or if you require this material in an alternate format, please contact a King County 504/ADA Disability Compliance Specialist at 206-296-7592 or 206-296-7596 TTY, or by e-mail: Civil-Rights.OCR@kingcounty.gov.

504/ADA General Information

Federal and State laws prohibit discrimination based on disability. Section 504 of the Rehabilitation Act of 1973, as amended (504), and the Americans with Disabilities Act of 1990 (ADA) require that King County and all organizations and firms contracting with King County, except those providing tangible goods, comply with the 504/ADA accessibility requirements.

Under 504 and ADA, a "qualified individual with a disability" is anyone who has, has a history of, or is perceived as having a physical or mental impairment which substantially limits one or more major life activities. Disabilities include, but are not limited to: mobility, visual, hearing, or speech disabilities; mental illness; epilepsy; learning disability; brain injury; HIV/AIDS; arthritis; cerebral palsy; multiple sclerosis; developmental disability; and alcohol and/or drug addiction.

DISABILITY RESOURCE LIST

Note: Inclusion in this resource list does not constitute endorsement by King County Government, nor does omission imply non-endorsement. Our goal is to provide you with information on some key resources available. Please contact us if you know of a useful resource missing from this list.

King County Office of Civil Rights

Disability Compliance Specialist, Yesler Building, 400 Yesler Way, Room 260, Seattle, WA 98104-2683; 206-296-7592 V, 206-296-7596 TTY; 206-296-4329 Fax; e-mail: Civil-Rights.OCR@kingcounty.gov
web site: www.metrokc.gov/dias/ocre

Governor's Committee on Disability Issues and Employment (GCDE)

Advises and informs the Governor, state and local governments, the business community, and the disability community on ADA and other issues related to disability policy.
Olympia: 360-438-3168 V, 360-438-3167 TTY; Spokane: 509-532-3149 V, 509-532-3113 TTY.

GCDE publishes "Producing Materials in Alternative Formats: A Guide for Agencies"

which provides information on producing materials in large print, on audio tape or computer disk, and Braille. Send a written request for a copy.

DBTAC Northwest

Provides information on the Americans with Disabilities Act in Alaska, Idaho, Oregon and Washington. Western Washington University 6912 220th St. SW, Suite 105 Mountlake Terrace, WA 98043
800-949-4232 V/TTY
425-774-9303 Fax
e-mail: dbtacnw@wwwu.edu
web site: www.dbtacnorthwest.org

Sprint Washington Telecommunications Relay Service (TRS)

Provides free telephone accessibility with TTY users. 500 108th Avenue NE, Suite 800, Bellevue, WA 98004; Relay Services: 711 TTY; 800-833-6384 V.

ADA Technical Assistance Hotline (U.S. Dept. of Justice)

Provides free technical assistance and informational materials to people with disabilities, businesses, state and local government agencies, and the general public on rights and responsibilities under Titles II and III of the ADA. 800-514-0301 V/TTY.
web site: www.usdoj.gov/crt/ada

Washington Assistive Technology Alliance (WATA)

Information & referral to disability resources, including assistive technology options, funding sources, legal issues, accommodations.
509-328-9350 V/TTY; 800-214-8731 V/TTY; 509-326-2261 Fax; e-mail: spokane@seals.org
web site: wata.org/wata/eatrc/index.htm

Job Accommodations Network (JAN)

An international toll-free consulting service that provides information regarding the ADA, job accommodations and the employability of people with disabilities. P.O. Box 6080, 918 Chestnut Ridge Road, Suite 1, Morgantown, WV 26506-6080;
JAN ADA Information 800-526-7234 V/TTY; 800-ADA-WORK (232-9675) V/TTY;
web site: janweb.icdi.wvu.edu

Emergency Procedures for Employees with Disabilities in Office Occupancies

A procedural guideline funded by the U.S. Fire Administration and developed by the National Institute of Standards and Technology with assistance from the National Task Force on Life Safety and People with Disabilities. Write for a copy of Item Number FA -154: United States Fire Administration, 16825 South Seton Avenue, Emmitsburg, MD 21727.

504/ADA SELF-EVALUATION QUESTIONNAIRE

General Requirements

Please check the appropriate answers. If necessary, attach additional pages of explanation. If you have fewer than 15 employees, please skip the first section and start with "Program Access."

- | | YES | NO | N/A |
|---|-------------------------------------|--------------------------|--------------------------|
| 1. Do you have a 504/ADA coordinator? If so, who? | <input checked="" type="checkbox"/> | <input type="checkbox"/> | <input type="checkbox"/> |
| Name <u>David K. Chapman</u> | | | |
| Title <u>Managing Director</u> Phone <u>206-624-8105x237</u> | | | |
| 2. Do you have an internal grievance procedure that allows for quick and prompt solutions for any complaints based on alleged noncompliance with 504/ADA? | <input checked="" type="checkbox"/> | <input type="checkbox"/> | <input type="checkbox"/> |
| 3. Do you have a policy that provides for notifying participants, applicants, employees, unions, and professional organizations holding collective bargaining or professional agreements that you do not discriminate on the basis of disability? | <input checked="" type="checkbox"/> | <input type="checkbox"/> | <input type="checkbox"/> |
| 4. Have you notified these individuals of your nondiscrimination policy? | <input checked="" type="checkbox"/> | <input type="checkbox"/> | <input type="checkbox"/> |
| 5. Do you provide ongoing staff training to ensure that staff fully understand your policy of nondiscrimination on the basis of disability and can take all appropriate steps to facilitate the participation of individuals with disabilities in agency programs and activities? | <input checked="" type="checkbox"/> | <input type="checkbox"/> | <input type="checkbox"/> |

Program Access

- | | | | |
|---|-------------------------------------|--------------------------|--------------------------|
| 1. Do you notify the public and other interested parties that agency meetings, board of director meetings, hearings, conferences, public appearances by elected officials, and interviews will be held in accessible locations? | <input checked="" type="checkbox"/> | <input type="checkbox"/> | <input type="checkbox"/> |
| 2. Do you notify the public and other interested parties that auxiliary aids (sign language interpreters, readers) will be provided, upon request, to participants with disabilities? | <input checked="" type="checkbox"/> | <input type="checkbox"/> | <input type="checkbox"/> |
| 3. Do you have a Teletypewriter (TTY), or do you use the statewide Telecommunications Relay Service to facilitate communication with individuals who use TTYs for communication purposes? | <input checked="" type="checkbox"/> | <input type="checkbox"/> | <input type="checkbox"/> |
| 4. Do you provide ongoing training to familiarize appropriate staff with the operation of the TTY (or Relay Service) and other effective means of communicating over the telephone with people with disabilities? | <input checked="" type="checkbox"/> | <input type="checkbox"/> | <input type="checkbox"/> |

Program Access (continued)

- | | YES | NO | N/A |
|--|-------------------------------------|-------------------------------------|--------------------------|
| 5. Do you make available, upon request, written material in alternate formats for people who have disabilities? (Alternate formats include large print, Braille, and audiocassette tapes) | <input type="checkbox"/> | <input checked="" type="checkbox"/> | <input type="checkbox"/> |
| 6. Are printed posters, announcements, and printed materials (including graphics) clearly legible and placed in physically accessible locations where print can be read from a wheelchair? | <input checked="" type="checkbox"/> | <input type="checkbox"/> | <input type="checkbox"/> |
| 7. If you have a mailing list for the purposes of information dissemination, does it include various disability groups? | <input checked="" type="checkbox"/> | <input type="checkbox"/> | <input type="checkbox"/> |
| 8. Are your TTY number and procedures for accessing your services printed on all material distributed to the public? | <input checked="" type="checkbox"/> | <input type="checkbox"/> | <input type="checkbox"/> |
| 9. Do you have a policy and procedure for safe emergency evacuation of people with disabilities from your facility(s)? | <input checked="" type="checkbox"/> | <input type="checkbox"/> | <input type="checkbox"/> |

Employment and Reasonable Accommodation

- | | | | |
|--|-------------------------------------|-------------------------------------|-------------------------------------|
| 1. When gathering affirmative action data regarding disabilities, do you make it clear that: | | | |
| • the information requested is intended for use solely in connection with reporting requirements; | | | |
| • the information is voluntary; | | | |
| • the information will be kept confidential; and | | | |
| • refusal to provide or providing the information will not subject the applicant or employee to any adverse treatment? | <input checked="" type="checkbox"/> | <input type="checkbox"/> | <input type="checkbox"/> |
| 2. If you make pre-employment medical inquiries or conduct pre-employment medical examinations: | | | |
| • Is the inquiry related to the applicant's ability to perform the job? | <input type="checkbox"/> | <input type="checkbox"/> | <input checked="" type="checkbox"/> |
| • Do you condition offers of employment on the results of these examinations? | <input type="checkbox"/> | <input checked="" type="checkbox"/> | <input type="checkbox"/> |
| • Is the examination required for <u>all</u> employees in the same job classification? | <input type="checkbox"/> | <input type="checkbox"/> | <input checked="" type="checkbox"/> |
| • Are <u>all</u> applicants in the same job classification asked the same medical and/or interview questions? | <input type="checkbox"/> | <input type="checkbox"/> | <input checked="" type="checkbox"/> |
| 3. During the application, interviewing, hiring, and employment process, do you provide reasonable accommodations to applicants and employees with disabilities? | <input checked="" type="checkbox"/> | <input type="checkbox"/> | <input type="checkbox"/> |

Employment and Reasonable Accommodation (continued)

YES NO N/A

4. Do you have a written policy stating the following?

504/ADA requires that information concerning an applicant's medical condition or history must be kept separate from personnel records and may be shared in only three ways:

- (1) supervisors and managers may be informed of restrictions on the work or duties of individuals with disabilities and informed of necessary accommodation(s);
- (2) first aid and safety personnel may be informed if the condition might require emergency treatment; and
- (3) government officials investigating compliance with 504/ADA shall be provided with relevant information upon request.

Physical Accessibility

Complete the "Quick Look" Barriers Checklist and then answer the following questions:

1. Is the building(s) where your business is located barrier-free?

2. If you checked NO to any of the items on the Employment and Reasonable Accommodation checklist above, would these areas prevent an individual with a disability from accessing your program(s) or service(s)?

If access would be impacted, describe on the Corrective Action Plan what steps will be taken to eliminate the barrier(s). If there are extenuating circumstances which would make barrier removal a financial or administrative burden, please explain in the Corrective Action Plan.

This 504/ADA Self-Evaluation Questionnaire was completed by:

David K. Chapman
Print name

12-17-07
Date

206-624-8105 x237
Phone Number

"QUICK LOOK" BARRIERS CHECKLIST

This checklist may be used to conduct a quick appraisal of potential problem areas for accessibility. For detailed review standards, refer to IBC 2003, ANSI A117.1-2003, and the Washington State Administrative Code (WAC) 51-50. If you are not located in State of Washington, you may refer to federal ADA Accessibility Guidelines (ADAAG), state or local laws and regulations.

Building Access	YES	NO	N/A
• Garage/lot has required number of accessible parking spaces?	<input checked="" type="checkbox"/>	<input type="checkbox"/>	<input type="checkbox"/>
• Are accessible parking spaces near main building entrance?	<input checked="" type="checkbox"/>	<input type="checkbox"/>	<input type="checkbox"/>
• Walkways are level (44" wide min.) or ramped (max. 1:12)?	<input checked="" type="checkbox"/>	<input type="checkbox"/>	<input type="checkbox"/>
• Does the entrance doorway have at least 32" wide clearance?	<input checked="" type="checkbox"/>	<input type="checkbox"/>	<input type="checkbox"/>
• Is the door threshold maximum ¼" high (½" if beveled)?	<input checked="" type="checkbox"/>	<input type="checkbox"/>	<input type="checkbox"/>
• Door hardware is lever handles, pulls, or push-pull activating bars?	<input checked="" type="checkbox"/>	<input type="checkbox"/>	<input type="checkbox"/>
• Are the doors easy to open (exterior doors max. 8.5 lbs. opening force, interior doors 5 lbs. max.)?	<input checked="" type="checkbox"/>	<input type="checkbox"/>	<input type="checkbox"/>
• If revolving doors used, alternate accessible entrance available?	<input type="checkbox"/>	<input type="checkbox"/>	<input checked="" type="checkbox"/>
Building Corridors			
• Is path of travel free of obstruction and at least 36" wide?	<input checked="" type="checkbox"/>	<input type="checkbox"/>	<input type="checkbox"/>
• Is floor surface stable, firm and slip resistant?	<input checked="" type="checkbox"/>	<input type="checkbox"/>	<input type="checkbox"/>
• Do obstacles (phones, fountains, etc.) protrude no more than 4"?	<input checked="" type="checkbox"/>	<input type="checkbox"/>	<input type="checkbox"/>
• If provided, minimum one public phone or water fountain accessible?	<input checked="" type="checkbox"/>	<input type="checkbox"/>	<input type="checkbox"/>
• Are elevator controls no higher than 48"?	<input checked="" type="checkbox"/>	<input type="checkbox"/>	<input type="checkbox"/>
• Are elevator markings in Braille and raised letters/numbers?	<input checked="" type="checkbox"/>	<input type="checkbox"/>	<input type="checkbox"/>
• Does elevator provide audible and visible signals?	<input checked="" type="checkbox"/>	<input type="checkbox"/>	<input type="checkbox"/>
• Floor of elevator cab is min. 51" x 68" (door offset) or 51" x 80" (door centered)?	<input checked="" type="checkbox"/>	<input type="checkbox"/>	<input type="checkbox"/>
Restrooms			
• Door hardware is lever handles, pulls, or push-pull activating bars?	<input checked="" type="checkbox"/>	<input type="checkbox"/>	<input type="checkbox"/>
• Do restroom entrance doors have at least 32" wide clearance?	<input checked="" type="checkbox"/>	<input type="checkbox"/>	<input type="checkbox"/>
• Is restroom large enough for wheelchair turnaround (5' diameter)?	<input checked="" type="checkbox"/>	<input type="checkbox"/>	<input type="checkbox"/>
• Does accessible stall door have at least 32" wide clearance?	<input checked="" type="checkbox"/>	<input type="checkbox"/>	<input type="checkbox"/>
• Are grab bars provided in accessible toilet stalls?	<input checked="" type="checkbox"/>	<input type="checkbox"/>	<input type="checkbox"/>
• Toilet seat top is 17-19" above floor?	<input checked="" type="checkbox"/>	<input type="checkbox"/>	<input type="checkbox"/>
• Sink has clear knee space under basin; exposed pipes are insulated?	<input checked="" type="checkbox"/>	<input type="checkbox"/>	<input type="checkbox"/>
• Faucets are lever-operated or push-type?	<input type="checkbox"/>	<input checked="" type="checkbox"/>	<input type="checkbox"/>
• Are soap and towel dispensers no more than 40" from the floor?	<input checked="" type="checkbox"/>	<input type="checkbox"/>	<input type="checkbox"/>
Reception and Personnel Office			
• Lower counter space in reception, customer service areas?	<input checked="" type="checkbox"/>	<input type="checkbox"/>	<input type="checkbox"/>
• Do doors have at least 32" wide clearance?	<input checked="" type="checkbox"/>	<input type="checkbox"/>	<input type="checkbox"/>
• Is the door easy to open (max. 5 lbs. opening force)?	<input checked="" type="checkbox"/>	<input type="checkbox"/>	<input type="checkbox"/>
• Door threshold is maximum ¼" high (½" if beveled)?	<input checked="" type="checkbox"/>	<input type="checkbox"/>	<input type="checkbox"/>
• Is the path of travel between furniture at least 36"?	<input checked="" type="checkbox"/>	<input type="checkbox"/>	<input type="checkbox"/>

Required Number of Accessible Parking Spaces

Total Garage/Lot Parking Spaces	Minimum No. of Accessible Spaces
1-25	1 (van accessible)
26-50	2 (including one van space)
51-75	3 (including one van space)
76-100	4 (including one van space)
101-150	5 (including one van space)
151-200	6 (including one van space)
201-300	7 (including two van spaces)
301-400	8 (including two van spaces)
401-500	9 (including two van spaces)
501-1000	2% of total spaces (every six accessible spaces include one van space)
More than 1000	20, plus 1 for each 100 over 1000 (every six accessible spaces include one van space)

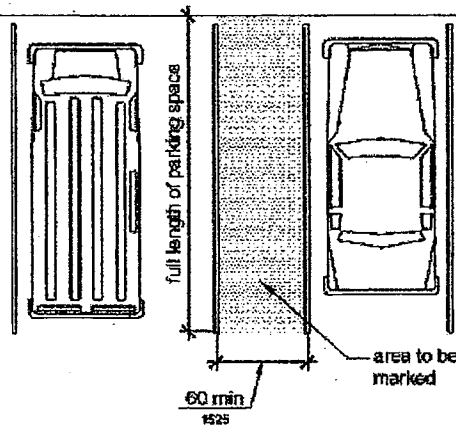

Locate accessible parking spaces on the shortest accessible route of travel to an accessible building entrance (where practical, not crossing traffic lanes).

Car and van parking spaces shall have an adjacent access aisle. Two parking spaces may share an access aisle. Van parking spaces that are angled shall have access aisles located on the passenger side of the parking space.

If there is only one accessible parking space, then it shall meet the codes for a van accessible parking space: 11' wide vehicle parking space plus a 5' access aisle. (An 8' vehicle parking space with an 8' access aisle is acceptable under code.)

For more detail, consult Washington State Building Code (WAC 51-50).

504/ADA DISABILITY ASSURANCE OF COMPLIANCE

Complying with Section 504 of the Rehabilitation Act of 1973, as amended, and the Americans With Disabilities Act of 1990, two federal laws which prohibit discrimination against qualified people with disabilities.

I understand that federal and state laws prohibit discrimination in public accommodations and employment based solely on disability. In addition, I recognize that Section 504 requires recipients of federal funds (either directly or through contracting with a governmental entity receiving federal funds) to make their programs, services, and activities, when viewed in their entirety, accessible to qualified and/or eligible people with disabilities. I agree to comply with, and to require that all subcontractors comply with, the Section 504/ADA requirements. I understand that reasonable accommodation is required in both program services and employment, except where to do so would cause an undue hardship or burden.

I agree to cooperate in any compliance review and to provide reasonable access to the premises of all places of business and employment and to records, files, information, and employees therein to King County for reviewing compliance with Section 504 and ADA requirements.

I agree that any violation of the specific provisions and terms of the 504/ADA Disability Assurance of Compliance and/or Corrective Action Plan required herein or Section 504 or the ADA, shall be deemed a breach of a material provision of the Contract between the County and the Contractor. Such a breach shall be grounds for cancellation, termination, or suspension, in whole or in part, of this Contract by the County.

According to the responses to the questions in the 504/ADA Self-Evaluation Questionnaire, Contractor is in compliance with 504/ADA. If the response is NO, the actions outlined in the below Corrective Action Plan will be taken.

YES NO

Contractor: Associated Counsel for the Accused
Company Name

110 Prattenton PL S #200 Seattle WA 98104
Street Address City State Zip

Corrective Action Plan

The following Corrective Action Plan is submitted to comply with Section 504 and ADA requirements.

Actions To Be Taken	General Requirements	Completion Date

504/ADA DISABILITY ASSURANCE OF COMPLIANCE (continued)

Program Access

Actions To Be Taken

Completion Date

Four horizontal lines for recording actions and completion dates under Program Access.

Employment and Reasonable Accommodation

Actions To Be Taken

Completion Date

Four horizontal lines for recording actions and completion dates under Employment and Reasonable Accommodation.

Physical Accessibility

Actions To Be Taken

Completion Date

Four horizontal lines for recording actions and completion dates under Physical Accessibility.

Declare Under Penalty of Perjury under the Laws of the State of Washington that the Foregoing is True and Correct.

Signature of authorized signator: David K. Chapman

Type or print name of authorized signator: David K. Chapman Title: Managing Director ALC Telephone: 206-624-8105/237

For Notary:

State of Washington, County of King

Signed and sworn before me on (date) 18th day of November, 2007 by (print authorized signator name) DAVID, K. CHAPMAN

Notary signature: Anne Greengo Dolan

Notary (print name): ANNE GREENGO DOLAN

My appointment expires: 6/6/2008

Note: This form may be used as an exhibit with other King County contracts for two years from the date the form is completed.

EXHIBIT V

PUBLIC DEFENSE LEGAL SERVICES

I. WORK STATEMENT

The Agency shall provide the services of attorneys and staff members in compliance with all of the applicable laws and administrative regulations of the State of Washington, the United States, King County Code (KCC), Washington State Rules for Professional Conduct (RPC).

II. PROGRAM DESCRIPTION

A. Goal

To provide legal services through effective assistance of counsel to indigent persons, that is statutorily and constitutionally based, within the framework of an efficient and fiscally responsible independent non-profit Agency.

B. Eligible Population

The population served shall be indigent persons legally entitled to appointed legal services in King County courts as assigned by the Office of The Public Defender (OPD) or as appointed from the bench.

C. Definitions

1. Case Categories:

a. Becca: CHINS/ARY/Truancy practice area:

i. CHINS/ARY Petition: A Child in Need of Services (CHINS) petition and At Risk Youth (ARY) petition involves the representation of one child or one parent from the filing of the petition through conclusion of services related to the petition. This includes representation on the initial petition, as well as any subsequent review hearings. In the event that a court consolidates a truancy matter with proceedings under a Youth at Risk or Child in Need of Services Petition, the Agency shall receive credit for the truancy representation.

ii. Truancy: A petition filed under Revised Code of Washington (RCW) 28A.225.030. A case assignment will be made when the Court notifies OPD of a signed judicial order, setting a show cause hearing for Contempt of Court and requiring appointment of counsel.

b. Calendars: The Agency shall provide coverage for calendars if indicated in Attachment B, Calendar Attorney and Staff List. The calendars are defined as follows:

i. Dependency Calendar: All initial 72-hour shelter care calendars in Seattle or Regional Justice Center (RJC) shall include the presence of an attorney.

- ii. General Attorney of the Day (AOD): The Agency will in good faith attempt to provide legal advice 24 hours a day seven days a week via beeper access and respond promptly to any accused adult or juvenile who is in the investigation phase or recently charged with a crime or detained on a civil matter within the jurisdiction of OPD. AOD for legal advice may occur both in RJC and Seattle. AOD includes a request from a defendant for substantial legal advice or a police agency to respond for line-up presentations. A call to the 24 hour beeper is calendar work not a case assignment.

Where substantial advice services are provided as a result of initial General AOD contact via beeper, credits can be requested as per Attachment A. "Substantial advice" includes legal services beyond providing of simple direct, one-time legal advice by phone or in person at a detention facility, and includes ongoing legal services preliminary to a formal appointment as counsel for prospective client.

Individual substantial advice assignments may also be appointed by the court or assigned by OPD, where the scope of work exceeds that described in the General AOD paragraph above.

- iii. Felony Arraignment Calendar.
 - iv. Felony Sentence Modification Calendar: The Superior Court Probation Modification Calendar.
 - v. Juvenile AOD: The Agency shall provide Juvenile Special Services which include making "morning rounds" in juvenile detention; lineups, detention reviews and arraignments; diversion counseling per RCW 13.40.080; and representing offenders as counsel until an attorney is formally appointed.
 - vi. Juvenile First Appearance Calendar: Each Agency representing juveniles shall provide representation on the Juvenile First Appearance Calendar. Representation of juveniles on this daily Juvenile Court Calendar shall include prior clients and/or unrepresented juveniles. Time spent on this calendar shall include preparatory work done concerning the juveniles listed on the calendar who do not appear because of expedited filing by the Prosecuting Attorney, release from detention prior to hearing, or other reasons for non-appearance.
 - vii. King County Court Misdemeanor calendars include: District Court Felony Investigation Calendar, Bench Warrant Return Calendar, and initial detention hearings for new misdemeanor charges.
- c. Civil Contempt of Court practice area: A civil contempt case shall include legal representation up to a maximum of three hearings, related solely to a contempt citation and shall be limited to cases where the

factual likelihood of loss of liberty arises from an act of King County or the State of Washington or a judicial act.

d. Dependency practice area: Coverage for all dependency, termination, guardianship, dependency guardianship, contested private adoption termination, and Reinstatement of Parental Rights cases.

i. Dependency Case: A dependency case credit is given for the legal representation of a client from:

- 1) The initial predispositional assignment through the dispositional hearing. Should an agreed order of dependency be entered on or before the date of the 30-day shelter care review, it shall be considered part of the dependency case. If the case is assigned to the Agency after the establishment of dependency and entry of the dispositional order, an initial case credit shall be given at the time of assignment; and
- 2) The filing of a termination or guardianship petition to the setting of a termination or guardianship trial date. Should an agreed order of termination or guardianship be entered on or before the preliminary hearing, it shall be considered part of the termination or guardianship case.
- 3) Appointment of counsel pursuant to RCW 26.33.110 for contested private adoption termination shall be considered a termination of parental rights appointment for credit purposes. The Agency shall not be required to have more than two open RCW 26.33.110 cases at a given time.

ii. Post-Dispositional Hearing: A dependency review shall include legal representation at any post-dispositional hearing or hearings related to the original dependency filing, excluding the initial 72 hour shelter care review, the 30-day shelter care review, and the dispositional hearing. Reviews included within this category shall include, but not be limited to: the initial progress review, six month review hearings, permanency planning hearings, new shelter hearings occurring post disposition, or other reviews or hearings set by the parties or by the court. If a review hearing is continued, additional credit shall not be allocated for the review unless the substantive issues within the review hearing change or substantial work is done. In the event that a court consolidates a family court matter with proceedings under a dependency case, pursuant to Local Juvenile Court Rules (LJuCR) 3.13, the Agency shall receive additional dependency review credit under this section for representation involving hearings in the consolidated matter.

iii. Dependency Trial/Termination or Guardianship Trial

- 1) A dependency trial shall include:

- a) A fact finding for a dependency and the preparation for said fact finding or the entry of an agreed order of dependency and agreed dispositional order at the time of the scheduled dependency fact finding; or
 - b) Entry of an agreed order of dependency and any contested hearing or hearings related to the dispositional order pursuant to the agreed order, as described in RCW 13.34.110 (1) and (2). This does not include post-dispositional review hearings.
- 2) A termination trial shall include:
- a) A fact-finding on a termination petition or guardianship petition and the preparation for said fact finding; or
 - b) Entry of an agreed order regarding termination or guardianship petition at the time of the scheduled fact-finding.
- iv. If more than one petition is pending involving one client, only one case shall be allowed credit. If matters involving one client with multiple petitions are severed for separate proceedings on different petitions, credit shall be given for such hearings. In the event that a new petition is filed as to a parent involving a child not previously involved in prior proceedings and that petition is filed post-disposition of previously filed petitions, then a new case credit will be allowed on the newly filed petition.
- v. Reinstatement of Parental Rights Matters: Representation of a client from the time of appointment of counsel through completion of the matter to point of either completed reinstatement of parental rights, or dismissal of the Petition for Reinstatement of Parental Rights. To the extent that any hearings held in this matter are also concurrently a permanency plan hearing or review hearing in the related dependency matter, no additional review credits are given for those hearings for purpose of the related dependency matter.
- e. Felony practice area:
- i. Felony Case: All legal representation related to a case filed in the Criminal Division of King County Superior Court by the King County Prosecutor's Office, alleging a violation of criminal law and having a maximum sentence of more than one year, through sentencing and any restitution hearing and as listed in Attachment A.
 - ii. Felony/Probation Review: A felony/probation review shall include legal representation at any hearing or hearings arising from a single notice of hearing subsequent to disposition of the

case. Areas within this category shall include, but not be limited to: probation reviews, revocations, early release, conditional release, safe-to-be-at-large, temporary release, medical release, and material witness hearings. A restitution hearing will be a review only if it is assigned to an agency other than the agency which represented the client at sentencing.

- iii. Persistent Offender (I 593 C 1 L 94; RCW 9.94A.030(33); RCW 9.94A.570): Persistent offender is a defendant as defined by RCW 9.94A.030(33) and subject to sentencing pursuant to RCW 9.94A.570. The Agency shall provide documentation to OPD to verify a persistent offender case status.
- iv. Complex Litigation: All death penalty homicide cases and all aggravated homicide cases. Aggravated homicide cases are considered death penalty cases until such time as decision is made by the Prosecuting Attorney not to file a notice of intention to seek death.
 - 1) Complex litigation cases are "pending" until completion of the guilt phase and penalty phase/sentencing.
 - 2) Aggravated homicide cases, in which the death penalty is not sought, shall occupy the portion of a full time attorney up to a maximum of one Full Time Employee (FTE) qualified at Senior Public Defense I level or above. Up to 0.5 FTE professional support staff will be assigned to each such case. Active Supervision will be assigned at up to 0.1 FTE.
 - 3) Aggravated homicide cases, in which the death penalty is sought, shall occupy the portion of two full time attorneys, up to a maximum of two FTE attorneys, deemed necessary by the Agency to provide effective assistance of counsel. The attorney component shall comply with SPRC 2, Superior Court Special Proceedings Rules – Criminal, as well as one FTE qualified at Senior Public Defender I, or above. A professional support staff will be assigned up to one FTE. Active Supervision will be assigned at up to 0.2 FTE.
 - 4) The Agency and the County understand that the portion of attorney(s) and professional support staff assigned to each complex litigation case may change from time to time as the case moves through the adjudication process. In the event that a case concludes sooner than scheduled in Attachment B, case credit allocation will be adjusted accordingly.

f. Involuntary Commitment practice area:

- i. Initial Petition: An involuntary commitment case shall include any hearing on a petition for involuntary commitment under one cause number including a hearing for probable cause, or any

petition for additional commitment under the same cause number pursuant to RCW 71.05.280, except such hearings defined in (ii) and (iii) below.

- ii. **180-Day Petition:** Any involuntary commitment case that went to a 180-day hearing following a petition filed pursuant to RCW 71.05.320 shall be considered a separate case and shall be billed by client name and shown separately. When a new docket number is assigned and the first court appearance is a 180-day hearing, the Agency will receive case credit and payment for either the assignment of the new docket number or the 180-day hearing, but not both.
 - iii. **Involuntary Medication Hearing:** A hearing held pursuant to a petition for involuntary administration of medications or electroconvulsive therapy shall be considered a separate case.
 - iv. **An alcohol involuntary commitment proceeding** filed pursuant to RCW 70.96A including all hearings under the same cause number shall be considered one case.
 - v. **A drug-related involuntary commitment** filed pursuant to RCW 70.96A including all hearings under the same cause number shall be considered one case.
- g. **Juvenile Offender practice area:** Coverage for all juvenile cases filed in juvenile court, including Diversion Calls.
- i. **Juvenile Offender Case:** A juvenile offender case includes any criminal charge filed by the King County Prosecutor's Office in King County Juvenile Court. A restitution hearing is included within the initial case credit.
 - ii. **Juvenile Offender Modification/Review:** A juvenile offender modification/review shall include a hearing or hearings related to the allegations contained in the notice of the modification/review. In the event that the juvenile respondent has several notices of modification/review because of different cause numbers and all such modifications/reviews are heard at a single hearing, then such hearing shall constitute one completed juvenile offender modification/review.
 - iii. **Juvenile Offender Restitution Review Hearing:** A juvenile offender restitution review hearing consists of a hearing or hearings related to the subsequent modification of restitution schedules set by the court for the particular juvenile offender. In the event that the juvenile has several pending restitution hearings and such hearings are all heard at the same hearing, then such completed hearing shall constitute one completed restitution review hearing.
- h. **Misdemeanor practice area:**

- i. Misdemeanor Case: Any criminal case, including traffic misdemeanors, filed by the King County Prosecutor in the District Courts.
 - ii. Misdemeanor Appeal: A misdemeanor appeal involves filing the notice of appeal, if necessary, perfecting the record following the filing of the notice of appeal, preparation of the transcript pursuant to Rule 6.3a Rules for Appeal of Decisions of Courts of Limited Jurisdiction (RALJ), preparing such briefs and memoranda as are required, arguing the case in Superior Court, and handling such paperwork as the Superior Court's decision and orders direct.
 - iii. Misdemeanor Writ: A writ involves filing notice, perfecting the record, preparing such briefs and memoranda as required, arguing the case in Superior Court and handling such paperwork as the Superior Court's decision and orders direct.
- i. Sexual Predator practice area: Legal representation for indigent persons assigned by OPD for cases filed under RCW 71.09, civil commitment petitions filed by the King County Prosecuting Attorney or the Attorney General's Office, subject to such conditions stated in the current Program Agreement, and General Terms Agreement between the County and the State of Washington Department of Social and Health Services (DSHS) from the effective date of these agreements, and directly invoice to and be reimbursed by DSHS at a rate determined by DSHS or as ordered by the Court.
- j. Specialty Court practice area:
- i. Specialty Court/Drug Court: Any criminal case filed into King County Superior Court Drug Court. Staffing is determined by a separate agreement, which is incorporated by reference herein.
 - ii. Specialty Court/District Mental Health Court includes: Any case filed into King County District Mental Health Court. Staffing is determined by a separate agreement, which is incorporated by reference herein.
2. Case Credit: Case credit is a unit of work. The total number of units that an attorney is expected to perform is listed in the case credit workloads of Section III. Program Requirements, of this Exhibit. Attachment A of this Exhibit defines the Case Credit Application and parameters for additional credit in extraordinary cases.

Extraordinary Case Credit: Extraordinary case types including Juvenile Felony Offender, Contempt of Court, Dependency, Termination of Parental rights, RCW 26.33.110 contested adoption termination, Reinstatement of Parental Rights, Murder, Persistent Offender, and all Adult Felony cases shall be given extra credits if the nature of the case requires such extra credits, based upon a written application from the Agency. Other case types may be approved for extraordinary credit at the discretion of OPD. Factors entering into the awarding of extra credits shall be as according to Attachment A.

3. **Criminal Case:** A case is any one charge or series of related charges filed against one defendant/respondent in a single charging document or in the case of misdemeanors a series of charges under several charging documents, set for one court hearing that will ultimately lead to one disposition.

- a. If a related series of charges is defined herein as a single case is subsequently set for separate disposition hearings or trials, the Agency may request additional credit for each case, which is severed from the consolidated case.
- b. If a new case is filed on a separate incident after case has been assigned, and a new count is charged but not a new court case number, the Agency may request additional credit for each case similarly filed. An incident is defined as a criminal charge alleged to have occurred on or about a specific calendar day. Multiple offenses charged as occurring on or about the same date are considered a single incident. A maximum of three credits shall be allowed, if requested by the Agency, per charging document regardless of the number of incidents alleged. Agency may apply for Extraordinary Case Credit if appropriate.
- c. Criminal charges alleged to have occurred on indeterminate dates or during a specified range of dates (e.g. on or between specific dates) are considered one incident. The Agency may present documentation to OPD to demonstrate that separate and discreet dates of incident were intended. Documentation should include such portions of pre-trial discovery to justify claim for separate incidents. In the event that such separate incidents are determined, a maximum of three credits shall be allowed, if requested by the Agency, per charging document.
- d. A completed case involves all necessary legal action from arraignment through disposition. This includes the filing of a notice of appeal upon the client's request, application to proceed in *forma pauperis* on appeal, and a motion for appointment of appellate counsel.
- e. A case remanded to the trial court for proceedings following appeal is a new case credit. The filing of an appeal (interlocutory appeal which is accepted for review by the appellate court or post-dispositional) closes the case for credit purposes.

4. **Criminal Case Disposition:** Case disposition shall mean the dismissal of charges, the entering of an order of deferred prosecution, an order or result requiring a new trial, imposition of sentence or deferral of same, or dispositional continuance and any other hearing on that cause number that occurs within 45 days of sentence, entry of an order for deferral of sentence, or dispositional continuance by District Court. Sentencing includes completed hearing on establishing restitution order. A motion to modify restitution shall be considered for additional credit if the motion occurs after 180 days.

A restitution hearing ordered at the time of original disposition shall be included as part of the case credit as defined by this disposition description. It shall include the filing of a notice of appeal, if applicable. It shall not include a felony or misdemeanor probation review unless such review occurs within 45 days of disposition. Additionally, it shall not include any hearing ordered at the

conclusion of a deferred sentence unless such hearing occurs within 45 days of sentencing.

5. **Indigent:** An indigent defendant is a person determined indigent by OPD or the Court as being eligible for a court-appointed attorney, pursuant to RCW 10.101, 13.34.090, and OPD policy. Defendants may be considered assigned until a screening for indigency is completed, pursuant to RCW 10.101.020(4). Defendants may be required to be re-screened if their financial situation changes or at each 180 days of Agency representation. If a defendant is found to be not indigent, OPD will inform the Agency and court. In the event the court removes the Agency from assignment or orders the Agency to withdraw as appointed counsel, credit for such representation by the Agency is determined by the terms of this Contract, including the relevant sections of Attachment A.
6. **Legal Services:** Legal service is legal representation provided by an individual licensed attorney, and associated professional support staff to an individual client, pursuant to a case assignment or court appointment. The attorney will be required by the Agency to satisfy the Code of Professional Responsibility, the law of the State of Washington and the United States in the full discharge of the duties to each individual client under this Contract.
7. **Professional support staff:** Investigators, social workers and paralegals.
8. **Supervision:** An attorney with significant experience who is capable of actively monitoring an attorney's work product, caseload management, and relationship with clients and is capable of providing legal advice and guidance in other areas relevant to assuring high quality staff attorney performance. The Agency will provide active supervision for each staff attorney, in the ratio of one supervisor per ten staff attorneys.

III. PROGRAM REQUIREMENTS

A. Services

1. **Case Credit Allocation and Case Assignment:**
 - a. OPD shall make reasonable efforts to maintain the Agency at the total case credit allocation and case assignment as shown on Attachment B of this Exhibit, for each quarter of the year. The quarterly case credit amounts in Attachment B are provided for planning purposes. OPD shall make reasonable efforts to distribute cases beyond variance consistent with the case credit allocation in Attachment B of this Exhibit and paragraph b. below. The variance in case distribution does not apply to calendars, specialty court agreements, complex felony cases, or Sexually Violent Predator cases.
 - b. The Agency shall accept case assignments within contracted subject areas, including case assignments above the projected variance levels. Agency refusal to accept an individual case assignment within contractual subject areas shall not in and of itself be considered a material breach of this Contract, however the County may determine such refusal requires Agency corrective action. The County shall pay

the Agency for work in excess of the variance levels according to Section IV of this Exhibit.

- c. The Agency shall accept all complex litigation cases as determined by OPD, after consultation with the Agency concerning capacity.
 - d. If the Agency has begun delivery of legal services and the defendant/respondent absconds for a period of 180 days or more, upon re-apprehension, the allocation of a new case credit shall be determined by OPD.
 - e. If the Agency is assigned to a case prior to arraignment, has not provided legal services, and the defendant fails to appear for arraignment, the case shall be returned to OPD within 30 days or as agreed with OPD, and the Agency shall be debited.
 - f. If, after initial assignment, additional charges are filed under the same cause number against the same defendant/respondent, and said charges arise out of a different allegation or series of allegations unrelated by transaction to the first charges, then additional case credit shall be granted according to paragraphs II.C.2, 3, and 4 above.
 - g. The Agency may be appointed by the court as standby counsel in pro se cases. If such appointment is made, the Agency shall receive one case credit, less previous credit assigned for case. The Agency is not necessarily expected to utilize its professional support staff for pro se case work. If professional support staff work is requested by the pro se defendant, the Agency may opt to reduce its credit allocation by 0.1 per case credit allocated by not utilizing Agency professional support staff. In the event that the Agency elects to not provide professional support staff services, then it is the responsibility of the pro se defendant to comply with OPD Expert Services protocols regarding requests for any such services as may be necessary. Standby counsel shall provide such assistance and advice as may be ordered by the court and otherwise as consistent by case law and other legal requirements, and applicable standards of attorney representation and attorney conduct, including pro se requests for expert services.
 - h. The Agency shall electronically file a Closed Case Report (Attachment D) each month with OPD which shall include all information requested in the report for the month indicated and be submitted to OPD no later than 20 days following the last day of the previous month. A case is considered closed for further credit for attorney time expended after 30 days past sentencing, or a dispositional order is filed, or upon filing of a Notice of Appeal, unless an additional court order appoints counsel.
2. Funds for payment for expert services are not included in this Exhibit. Requests for appointment for expert service shall be made following OPD procedure for allocation of expert services. The Agency must assure that its staff follows the OPD expert procedures, as agreed with OPD.
 3. The Agency shall fully participate as requested by the County in Superior Court and OPD planning and responsibilities for providing services in the event of a

natural disaster, a major disruption to court processes, or a pandemic. The Agency shall develop and maintain disaster plan protocols which shall include a provision for daily contact with OPD and the Courts to verify court calendars requiring counsel presence. The parties acknowledge that all such plans presume the continued ability to communicate between the Agency and OPD. OPD shall assist the Agency in coordination with the courts and general implementation of the disaster plan.

The Agency shall submit within six months of the execution of the Contract the necessary plans, procedures and protocols to respond to and recover from a natural disaster or major disruption to agency operations such as a work stoppage; and continue operations during a prolonged event such as a pandemic. The plans shall be consistent with written County disaster plans for purposes of continuation of court business in the event of a disaster.

B. Practice Standards and Records

1. The Agency shall require that all attorneys, professional support staff and supervisors maintain contemporaneous records of all legal services provided on a specific case. The records shall provide a factual description of the work done and shall be sufficiently detailed to allow monitoring of legal service activity by OPD.
2. Upon closing a case, all attorney, professional support staff and supervisor files associated with the case shall be cross referenced and accessible as a whole for OPD monitoring.
3. The Agency shall maintain professional practice standards in providing a level of legal service that does not fall below the minimum professional standards and RPCs of the Washington State Supreme Court, the Washington State Bar, the National Legal Aid & Defender Association, and any applicable case law and court rules that define the duties of counsel to their clients. The Agency shall formally adopt the internal Agency practice standards as submitted to OPD February 1, 2006, and shall include a procedure for monitoring compliance with the standard. Case credit workload standards shall be according to paragraph III.B.14. below.
 - a. Attorney practice standards, include but are not limited to:
 - i. Lawyer-client relationship, initial case actions, investigation and preparation, preliminary hearings; disposition without trial; trial; post conviction or fact finding and any other areas of attorney practice deemed appropriate by Agency management or Board.
 - ii. Attorney use of professional support staff services and expert services.
 - b. Professional support staff service practice standards.
 - c. Practice standards for supervision of attorneys and professional support staff services.
4. The Agency agrees that, within available resources, reasonable efforts will be made by the Agency to continue the initial attorney assigned to a client

throughout any case in which representation is undertaken. The Agency is not prohibited from rotating attorneys through various Agency divisions or from assigning a single attorney to handle various aspects of legal proceedings for all indigent persons where such method of assignment is the most reasonable method of obtaining effective legal representation for indigent persons.

5. The Agency agrees that a member of the Agency staff shall visit any assigned in-custody criminal defendant, in-custody civil commitment, or dependency clients, and obtain basic contact and other fundamental intake information for a bond hearing within one business day from notification to the Agency of the assignment of the case and the in-custody status of the client, and/or within one business day upon notification of transport to a local detention facility. This provision applies to clients in custody at any facility within the King County jail. If a client is in custody in a non-County jail, the Agency shall make contact within three business days of receiving the assignment.
6. The Agency agrees that an attorney shall make contact with all assigned persons within five working days from a case assignment, or in rare occurrences where this is not achieved the Agency shall document reasonable efforts to make said contact.
7. The Agency agrees that a preliminary written response to any written complaints from OPD concerning services provided by the employees of the Agency or the Agency itself shall be submitted to OPD within three working days of the date the complaint is received by the Agency Director or the Director's designee. Written complaints include email communications from OPD; email response date will be provided.
8. Upon assignment of any client charged with a criminal case to an Agency, the Agency shall make diligent and reasonable efforts to obtain discovery within five business days of the assignment, whether initial or subsequent, on any case. In all cases, discovery shall be reviewed as soon as possible and in no event later than five business days after receipt for purposes of determining any conflicts of interest. The Agency shall notify OPD immediately and no later than 14 calendar days from assignment without good cause shown, of any conflict of interest as defined by the Washington State Rules of Professional Conduct. The Agency shall state the basis when possible, as court determines, for the conflict in its written notification.
9. The Agency shall establish and enforce policies and procedures to ensure that attorney time and other Agency resources funded by this Contract shall be for work, which is the subject of this Contract.

The Agency shall establish policies and procedures for pro-bono work provided by staff of the Agency. These policies and procedures shall assure that any such pro bono work is not provided to the exclusion or detriment of legal services that are the subject of this Contract.

10. Attorney Professional Support Staff

The Agency shall provide sufficient professional support staff, including investigators, social workers and paralegals to provide for effective assistance of counsel.

11. Minimum Attorney Qualifications

- a. Attorneys shall have the requisite qualifications for the cases to which they are assigned by the Agency, consistent with Washington State Bar Association (WSBA) Standards for Public Defense Services, Standard Fourteen, Qualifications for Attorneys, as adopted in 2007 and as may be amended by WSBA during the Contract period.
- b. Each staff attorney representing any client assigned by OPD shall work under the supervision of a supervising attorney employed by the Agency. Such supervision shall provide the staff attorney with sufficient resources so the attorney will be able to handle cases on his/her own. The employees of the Agency are not employees of the County and the County will not provide supervision to any of the Agency's employees.
- c. The Agency may choose to use Rule 9 Interns or Rule 8 attorneys, as allowed by Washington State Bar Association regulations.

12. Attorney/Professional Support Staff Evaluation

The Agency director, or his/her designee, shall evaluate the professional performance of each individual Agency attorney and professional support staff member annually. Attorney evaluations shall include: quality of case preparation, compliance with the requirements of this Contract, monitoring of time and caseload records, review of case files, and in-court observation.

Professional support staff evaluations shall be sufficiently comprehensive to assess the quality of the actual work performed.

The Agency shall keep a written record of all required performance evaluations.

13. Attorney/Professional Support Staff Training

The Agency shall provide access to sufficient training to support attorney and professional support staff performance of duties under this Contract. The Agency shall maintain all necessary records to assess the adequacy of the training. A Continuing Legal Education (CLE) approved by the Washington State Bar Association is presumptively adequate.

At a minimum during the Contract period, the Agency shall require each attorney to attend at least seven WSBA approved credits of CLE in a practice area under this Contract. Each Agency attorney must attend training approved by WA State OPD, pursuant to RCW 10.101.050 and as posted on WA State OPD website, at least once per calendar year. Each Agency attorney also shall satisfy the minimum requirements for practicing law in the State of Washington as determined by the Washington Supreme Court.

14. Case Credit Workload Guidelines

The County shall review Agency case credit workloads, case assignments, standards, and support staff/attorney ratios for each area of cases to assess compliance with the requirements of this Contract.

The total amount of reimbursement included in this Contract resulted from the application of the Public Defense Payment Model approved by the King County Council by Motion 12160 on July 18, 2005. Pursuant to the policies stated in Motion 12160, the allocation for each case area was calculated to provide funding for public defenders at parity with similarly situated attorneys in the Office of the Prosecuting Attorney. The Agency's staffing plan may be reviewed by OPD to verify that an attorney's experience level meets or exceeds required experience for case practice area, and placement within the salary schedule is reasonable. The Agency agrees to comply with the following average annual case credit work loads per attorney per case type:

Supervisors	0
Felony	150
Complex	150
593	150
King County Misdemeanor	450
Juvenile*	330
* KCC Motion supplemented by WA State funds (see Att C of this Exhibit) to allow effective caseload of 250	
Dependency	180
Becca	(refer to IV.H. of this Exhibit)
Contempt of Court	225
Involuntary Treatment Act (ITA)	410

A supervisor, including a managing director or assistant director, may provide minimal representation to clients under this Exhibit solely for the purpose of addressing management issues, emergencies or caseload overflow beyond the projections. OPD shall be notified of primary representation by supervisory staff constituting a caseload that exceeds available one to ten ratio of supervisory availability.

15. The Agency agrees to abide by the OPD Withdrawal procedures (Attachment E) when declining a case or withdrawing from a case because of a conflict of interest. Agency may withdraw only pursuant to applicable court rules and RPCs. Agency attorney shall promptly notify the court of any conflict of interest or any other reason requiring withdrawal from a case assigned under this Exhibit. The Agency shall submit the Withdrawal form to OPD and the case will be re-assigned by OPD upon receipt of signed Court Motion or if case is an early assignment (pre-court appointment) from OPD, OPD may re-assign the case in advance of Court appointment and/or Motion. Credits shall be applied according to the terms of this Exhibit, including Attachment A.

16. The Agency shall report all extraordinary occurrences to OPD in accordance with the Extraordinary Occurrences Policy and Procedure, and cooperate with any OPD extraordinary occurrence review. The Agency shall adopt an Agency specific extraordinary occurrence policy. The requirement to report to OPD does not replace reporting requirements by other entities.

17. The Agency shall have a process for the filing and review of complaints that are brought to the Agency's attention by clients, OPD, or other criminal justice system staff. The Agency shall establish an internal complaint procedure that is accessible to all clients, in accordance with RCW 34.05, 49.60, RPCs, and the OPD Client Complaint Services Policy and Procedure. The Agency shall maintain a file system for reliable report backup of each complaint.
18. The Agency agrees to abide by the terms of the OPD Attorney Supervision Policy and Procedures.
19. The Agency shall have an Information System (IS) that can report accurate data to OPD, and shall comply with the OPD IS Policy and Procedure. The Agency shall have functional personal computers using a Windows Operating System version 2000 or above and shall be connected to the Internet with the following supports:
 - a. The Agency shall have at least one trained primary and one trained backup on-site IS support person who has training on Basic Administration of Windows 2000, and other basic software training.
 - b. The Agency shall notify OPD, in writing, of staffing changes (i.e. new hires, transfers, and terminations) for those staff directly responsible for data reporting and IS maintenance.
 - c. If a virus attacks an Agency computer, Agency response must be immediate (i.e. within 15 minutes) to take the computer off line and other appropriate action.

IV. COMPENSATION AND METHOD OF PAYMENT

- A. The Agency shall be paid monthly as provided in Attachment C of this Exhibit except as paragraph IV B. applies. The Payment Schedule shall pertain to all cases assigned to the Agency from January 1, 2008 through December 31, 2008. The Agency shall submit reports in a format approved by the County, as stated in Section V. Reporting Requirements of this Exhibit. The reports are due within ten days after Agency receipt of the OPD Case Credit Certification Report.
- B. Payment shall be made monthly, subject to performance requirements being met and upon completion of scheduled corrective action requirements noted in the OPD 2007 site visit review and the Agency plan for corrective action. For each corrective action due date missed by the established due date, one percent of the subsequent month's payment will be withheld until action is completed or report is received and accepted by the County.
- C. Payments may be made for extraordinary expenses that are in addition to those payments shown in Attachment C, Payment Schedule. Extraordinary expenses shall be approved in writing in advance of the expenditure by OPD.
- D. In the event that workload demand exceeds the projected levels, the Agency shall accept case assignments and case credits above the variance levels on a monthly basis. OPD will monitor the distribution on a cumulative monthly basis to ensure that a reasonable distribution of cases has been maintained.

- E. For quarterly and annual payment purposes, the variance shall be no more than five percent, for all case areas except felony cases, which shall have a variance of no more than two-and-one-half percent. These variance percentages will be applied to the projected caseload to establish the variance range.
- F. Quarterly reconciliation: At the end of each quarter, OPD will evaluate the case credit accumulation for each Agency for each case type. Action taken will be as follows:
1. The actual quarterly caseload for each type of case area, as shown in the quarterly Certified Statistics will be compared to the actual variance range, for each practice area. Variance does not apply to calendars, specialty court agreements, or Sexually Violent Predator cases.
 2. If the Agency's actual quarterly caseload falls within the high and low values of the variance, an adjustment to the reimbursement will not be made.
 3. If the Agency's actual quarterly caseload falls outside of either the high or low values of the projected variance range, an adjustment to the payment may be made.
 4. If a quarterly reconciliation results in payment due to the Agency from the County, the Agency may, at the Agency's option, defer such payment to a later month in the Contract year.
 5. If the quarterly reconciliation results in payment due to the County from the Agency, the County may, at the County option, defer such payment to a later month in the Contract year.
- G. Year end reconciliation: The final payment will be the result of a reconciliation of actual performance to Contract specifications. The reconciliation will be conducted as follows:
1. The annual variance percentages outlined in Section III. Program Requirements will be applied to the projected caseload to establish the variance range.
 2. The actual annual caseload for each type of case will be compared to the variance range for each type of case, except for complex felony cases, calendars, specialty court agreements, or Sexually Violent Predator cases.
 3. If the Agency's actual annual caseload falls within the high and low values of the variance, an adjustment to December reimbursement will not be made.
 4. If the Agency's actual annual caseload falls outside of either the high or low values of the projected variance range, an adjustment to the final payment will be made.
- H. Becca Cases: The Agency shall be paid by OPD for CHINS, ARY, and Truancy legal services from funds provided by the State of Washington through King County Superior Court, Juvenile Court Services, and such additional funds as may be made available by King County.
1. Truancy. Truancy cases will be counted as one credit for the filing of a truancy contempt of court where the right to counsel attaches. No additional credits will be given for review hearings.

2. ARY/CHINS. ARY and CHINS cases will be counted as one credit for new assignments on a petition for ARY or CHINS. The initial case credit will include two review hearings. Review hearings after the first two on that petition will earn one third (.33) credit per review.
 3. Review hearings. All hearings subsequent to the hearing in which the ARY or CHINS fact finding is completed and in which disposition of the petition is ordered, if ordered in a separate hearing, will be considered a review. Any contempt hearing ordered on the original petition post disposition will be considered a review credit, if the matter is handled within the proceedings relating to the ARY or CHINS petition. Hearings relating to the contempt in the ARY or CHINS proceeding which occur post disposition of the contempt matter will be considered a review hearing.
 4. Truancy credit load limit. For purposes of this contract, Truancy cases will have a case credit load limit of 375 credits per FTE attorney per year.
 5. ARY / CHINS credit load limit. For purposes of this contract, ARY and CHINS cases will have a case credit load limit of 250 credits per FTE attorney per year.
 6. A variance of five percent applies to Becca cases in total, as counted in aggregate in this Contract. Site specific estimates included in Attachment B are for Agency management purposes only.
 7. The Agency agrees to provide attorneys for the same court sessions and calendars in 2008 as it did in 2007.
- I. Sexual Predator cases: The Agency shall be paid by the State of Washington for cases filed under RCW 71.09 and assigned to the Agency by OPD at a rate determined by DSHS or as ordered by the Court. Agency reimbursement shall be based on submission of expenditure reports and an invoice to DSHS in a format approved by DSHS. OPD shall apply its policies and procedures, as amended and posted on its website, to review and approve or deny requests from Agency counsel for use of Expert Services in 71.09 cases. Such authorization for Expert Services shall be made at the sole discretion of OPD. Upon approval or denial of counsel's request for Expert Services, OPD shall notify counsel. Per OPD policy, defense counsel may appeal an expert service denial to the court. Expert service reimbursement shall be invoiced to and provided directly by DSHS.
- J. Prepayments
1. The Agency shall ensure that it has sufficient funds to complete prepaid cases assigned but not completed at the end of the Contract period. The Agency must report its calculated prepayment retention amount and cost estimate, include the method of calculation, and provide a conclusion about whether the funds available would cover all costs associated with completing the cases assigned and prepaid. Not having an adequate reserve shall not be cause for a material breach of contract, but may require Agency corrective action.
 2. In the absence of a precise calculation of prepayments by the Agency, the County shall estimate the sufficiency of funds using the following formula:

For all felony, misdemeanor, initial dependency assignments, and juvenile offender cases assigned during October, November, and December that remain open at year-end, it is assumed that October cases are 75 percent completed, November cases are 50 percent completed, and December cases are 25 percent completed. For dependency cases it is assumed October cases are 15 percent completed, November cases are ten percent completed, and December cases are five percent completed.

The estimation shall be the result of calculating the number of open cases for each month by the corresponding percentage of uncompleted work, and then determining the sum of the uncompleted case count by the per case revenue amount to determine the sufficiency of funds.

V. REPORTING REQUIREMENTS

Compliance with the terms of this Exhibit requires the following reports, in a format approved by the County, to be submitted at the times indicated in the chart below.

Report Title	2008 Due Date
Closed Case Reports Persistent Offender (593) Monthly Case Report Additional Credit forms Monthly Expenditure Reports Complex Litigation time sheets Extraordinary Case Credit requests	Monthly, or more frequently if necessary
Year-end Attorney Case Assignment Report	January
Agency Disaster Plan	June
Annual Financial Statements, IRS Form 990, Audit Report including management letters.	August
Additional summaries, reports or documents, corrective actions directly related to Contract performance, as requested by OPD with reasonable notice.	Varies

ATTACHMENT A

Case Credit Application Schedule

Type of Case	
██████████	
One completed case	One case credit
Atty/Day or substantial advice	.10 case credit
Atty/Day or substantial advice in the King County Detention Facility	.20 case credit
Probation, other reviews, or sentencing only	.33 case credit
Assignment for Motion to Withdraw Guilty Plea or a Motion for New Trial based on a claim of ineffective assistance of counsel	One case credit
Murder 1	Two case credits upon assignment
Murder 2	Two case credits upon assignment
Persistent Offender (593)	<p>One case credit upon assignment, less previously assigned felony credit. The Agency is eligible for additional case credit for each additional 12.1 hours or portion thereof of attorney time on the case according to the Extraordinary Cases section of this Attachment A. The Agency shall report monthly to OPD the total attorney time in each persistent offender case in a format consistent with Attachment F categorizing attorney hours. It is understood that the Agency director or the director's designee will review the status of all pending persistent offender cases in the Agency at least monthly and will discuss the cases with the attorneys representing the clients. Such review will include the status of investigation, preparation and presentation of mitigation packages, legal and factual issues in the case, the client's physical and mental status, and any plea bargaining offers.</p> <p>This reimbursement method shall be in place until such time as the King County Council approves, by motion, a change in reimbursement methodology, and such time when the Council approved change is amended to this Contract.</p>
Felony Bench Warrant during case	One case credit if more than 180 days has passed since the date of the bench warrant and if the bench warrant was on a new case assignment; or 0.33 case credit if warrant was a probation review or other hearing valued at 0.33 credit.

Type of Case	
Case transferred to another agency, assigned counsel, or retained counsel	Substantial advice credit if case is not completed prior to transfer and if Agency provides to OPD satisfactory justification for credit. In the event that award of substantial advice credit alone results in a substantial financial hardship to the Agency, the Agency may request additional credit. Factors to be considered for additional credit include advanced stage of proceedings (e.g. set for plea, set for or approaching trial date, substantial amount of work expended).
Case transferred to drug court	One case credit
Complex litigation	
Capital cases	Two FTE attorneys; 25 complex litigation case credits per month maximum plus support staff as approved.
Aggravated Homicide	One FTE attorney; 12.5 complex litigation case credits per month maximum.
King County District Court	
One completed case, King County District Court	One case credit
District Court review, revocation, re-sentencing or other hearing	One case credit
One District Court expedited felony	One case credit
Misdemeanor Appeal	Four case credits
Misdemeanor Writ	Three case credits
Atty/Day or substantial advice; excludes misdemeanor beeper calendar matters listed in Attachment B and other calendar representation	0.10 case credit
Atty/Day or substantial advice for In-custody clients; excludes misdemeanor beeper calendar matters listed in Attachment B and other calendar representation	0.20 case credit
Decline hearing	
One completed case	One case credit
Decline hearing	One case credit

Type of Case	
Reviews	0.33 case credit
Atty/Day or substantial advice	0.10 case credit

A dependency case	One case credit
Post Disposition Review Hearing	0.40 case credit
Dependency trial	0.50 case credit
Termination trial	One case credit
Atty/Day for substantial advice	0.10 case credit
Registration of Parental Rights	
Child and/or parent may be represented	One case credit

From show cause initial assignment hearing up to and including two contempt reviews	One case credit
Subsequent reviews	0.33 case credit
_____	One case credit for one completed case – petition through closure.
_____	One case credit
_____	Calendar funding
_____	Calendar funding

New statutory mandates	Case types not contemplated by this Contract arising from legislation with effective dates after January 1, 2007 shall be assigned by OPD and accepted by the Agency subject to agreement on the credit to be given.

Type of Case	
Extraordinary Cases	<p>Extraordinary Juvenile Felony Offender, Dependency, Termination of Parental Rights, RCW 26.33.110 contested adoption termination, Reinstatement of Parental Rights, Murder, Persistent Offender, and all Adult Felony cases shall be given extra credits if the nature of the case requires such extra credits, based upon a written application from the Agency for additional credits and negotiation between OPD and the Agency. Factors entering into the awarding of extra credits include, but are not limited to: seriousness of the charges; amount and complexity of evidence; number of witnesses; unusual legal issues; number of defendants; whether there is a plea, bench trial or jury trial; number of pre-trial motions or hearings needed; severity of the consequences; and actual length of trial.</p> <p>The Agency application must be specific about the work to be done or completed to date, the estimated length of time to perform the work, and the personnel that will be assigned to perform the work. Initial OPD response to the Agency, including requests for additional information, shall be made within five business days from OPD receipt of Agency application.</p>
Credit for cases where the Agency withdraws due to a conflict of interest	<p>When the Agency has reviewed discovery and reported to OPD its withdrawal for reason of conflict and requested credit for time expended, OPD shall review the Agency's request for credit, including the reason given for withdrawal and may grant appropriate credit. Should such credit be denied, OPD shall inform the Agency of the basis for denial.</p>
Pro Se/Standby Counsel	<p>One case credit if professional support staff work is performed by the Agency and requests for appointment of professional support staff at public expense outside of the Agency are not submitted to OPD. If professional support staff work is requested by the pro se defendant, the Agency may inform OPD that it is opting to reduce its credit allocation by 0.1 per attorney credits assigned in the case by not utilizing its professional support staff.</p>

ATTACHMENT B

Agency Case Credit Allocation and Cases Assigned Estimate for January - December 2008

Case Category	Total Agency Case Credit Allocation	Agency's % of Total OPD Case Credits	1st Quarter	2nd Quarter	3rd Quarter	4th Quarter
<i>Felony & 593s</i>	3,049.0	27%	762.0	763.0	762.0	762.0
<i>Complex</i>	150.0	25%	75.0	75.0		
Total Felony	3,199.0		837.0	838.0	762.0	762.0
KC Misdemeanor	2,637.0	31%	659.0	659.0	660.0	659.0
Juvenile Offender	1,228.0	31%	307.0	307.0	307.0	307.0
Dependency	219.0	7%	55.0	55.0	55.0	54.0
COC	537.0	22%	134.0	134.0	134.0	135.0
Becca – Estimated DYS	260.6		65.0	65.0	65.0	65.6
Becca – Estimated RJC	430.9		108.0	108.0	107.5	107.4
Total Becca (new cases)	691.5	49%	173.0	173.0	172.5	173.0
TOTAL	8,511.5	25%	2,165.0	2,166.0	2,090.5	2,090.0

2008 Calendar Attorney and Staff List

Case Area	KCCF	RJC	Calendar	Agency	Day	Time	Atty	Staff	Supv
FELONY	x		Fast Track Drug (FTD) arraignment calendar	ACA	Mon-Fri	8:30-noon	0.50	0.25	0.05
		x	Felony arraignment calendar	ACA	Mon-Thurs	8:30-noon	0.40	0.25	0.04
KC MISDEMEANOR	x		Change of venue & 1st appearance	ACA	Mon-Fri	8:30-noon	0.50	0.25	0.05
		x	Change of plea calendar (in-custody) & 1st appearance	ACA	MWF	1:30-4:30	0.30		0.03
		x	Domestic Violence Court calendar	ACA	Mon-Fri	8:30-5:00	1.00	0.25	0.10
			Southwest District Court	ACA	Thurs or Fri	8:30-4:30	0.20		0.02
JUVENILE	x		1st appearance & diversion calls	ACA	Mon-Fri	1-4 pm	0.20		0.02
DEPENDENCY	x	x	Attorney of the Day (AOD) 72-hour Shelter Care	ACA	Mon-Fri	8-noon	0.30		0.03
MENTAL HEALTH COURT (District)	x		MHC Court calendar	ACA			1.50	1.00	0.15
DRUG DIVERSION COURT	x		Drug Diversion Court calendar	ACA	Mon-Fri		4.20	0.80	0.42
SUB-TOTAL							9.10	2.80	0.91

Beeper Duty \$11,549
 (\$30/day * 365 days) + 2008 COLA

ATTACHMENT C

Payment Schedule

This Payment Schedule shall pertain to all cases assigned to the Agency from January 1, 2008 to December 31, 2008. In 2008, the Agency shall be paid the following monthly amounts for cases and special services:

2008	Jan Payment	Feb Payment	Mar Payment	Apr Payment	May Payment	Jun Payment
Felony (regular & 593s)	283,504	283,504	283,504	283,504	283,504	283,504
Felony (complex) ^a	27,896	27,896	27,896	27,896	27,896	27,889
Juvenile	51,096	51,096	51,096	51,096	51,096	51,096
King County Misdemeanor	80,706	80,706	80,706	80,706	80,706	80,706
Dependency	16,937	16,937	16,937	16,937	16,937	16,937
Contempt of Court	31,581	31,581	31,581	31,581	31,581	31,581
Drug Diversion Court	48,832	48,832	48,832	48,832	48,832	48,832
Mental Health Court	18,134	18,134	18,134	18,134	18,134	18,134
CJ Mental Health Court	2,005	2,005	2,005	2,005	2,005	2,005
Calendar Staffing	40,142	40,142	40,142	40,142	40,142	40,142
Agency Admin & Overhead:						
Administration	48,372	48,372	48,372	48,372	48,372	48,371
Indirect Cost	28,222	28,222	28,222	28,222	28,222	28,223
Rent	49,035	49,035	49,035	49,035	49,035	49,035
Total Agency Admin & Overhead	125,629	125,629	125,629	125,629	125,629	125,629
Becca	29,712	29,712	29,712	29,712	29,712	29,712
Juvenile 10.101 ^c	17,742	17,742	17,742	17,742	17,742	17,742
ACA TOTAL	773,916	773,916	773,916	773,916	773,916	773,909

2008	Jul Payment	Aug Payment	Sep Payment	Oct Payment	Nov Payment	Dec Payment	TOTAL Jan-Dec 2008
Felony (regular & 593s)	283,504	283,504	283,504	283,504	283,504	283,510	3,402,054
Felony (complex) ^a							167,369^b
Juvenile	51,096	51,096	51,096	51,096	51,096	51,119	613,175
King County Misdemeanor	80,706	80,706	80,706	80,706	80,706	80,706	968,472
Dependency	16,937	16,937	16,937	16,937	16,937	16,930	203,237
Contempt of Court	31,581	31,581	31,581	31,581	31,581	31,572	378,963
Drug Diversion Court	48,832	48,832	48,832	48,832	48,832	48,841	585,993
Mental Health Court	18,134	18,134	18,134	18,134	18,134	18,148	217,622
CJ Mental Health Court	2,005	2,005	2,005	2,005	2,005	1,990	24,045
Calendar Staffing	40,142	40,142	40,142	40,142	40,142	40,142	481,704
Agency Admin & Overhead:							
Administration	46,116	46,116	46,116	46,116	46,116	46,116	566,927
Indirect Cost	26,906	26,906	26,906	26,906	26,906	26,900	330,763
Rent	49,035	49,035	49,035	49,035	49,035	49,033	588,418
Total Agency Admin & Overhead	122,057	122,057	122,057	122,057	122,057	122,049	1,486,108
Becca	29,712	29,712	29,712	29,712	29,712	29,708.50	356,540.50
Juvenile 10.101 ^c	17,742	17,742	17,742	17,742	17,742	17,743	212,905
ACA TOTAL	742,448	742,448	742,448	742,448	742,448	742,459	9,098,187.50

^a Payment is made on a per credit basis for cases open during the month.

^b This total amount is estimated in consideration of cases open at the beginning of the contract. The actual annual amount may be greater or lesser depending upon new case assignments and the timing of case closing for existing cases.

^c Public Defense Improvement Fund from the Washington State Office of Public Defense.

ATTACHMENT D

Closed Case Report

Period Covered:

Case Number	Client	Primary Attorney	Case Type	Dispos. Date	Help Close Date	Charge/Case Type	At Filing	At Disposition	Total Attorney	Invest.	Social Worker	Paralegal	Other Staff

*Primary Attorney indicates the agency-assigned attorney who performed primary case management.

ATTACHMENT E

NOTIFICATION OF WITHDRAWAL

PLEASE PRINT OR TYPE

Date: _____

Client Name: _____ AKA: _____

Address: _____ Phone: _____

DOB: _____ JCN: _____ CCN: _____

Cause Number: _____ Charge: _____

Case Type: Felony Seattle Municipal Juvenile
 Dependency Civil Contempt KC Misdemeanor
 ITA Other _____

REASON FOR WITHDRAWAL:

Conflict of Interest Other _____

Defendant Retained Private Counsel: (Name of Attorney) _____

CONFLICT INFORMATION:

This Agency's conflict is with: Name _____ DOB: _____

Cause Number: _____ Co-Defendant in Current Case? Yes No

Victim/Client Suspect/Client Witness/Client Other _____

OTHER NAMES IN DISCOVERY:

NAMES	DOB	STATUS IN CASE	REPRESENTATION HISTORY

SEE ATTACHED SHEET FOR ADDITIONAL LISTINGS

In-Custody Out-of-Custody Received Conflict From: _____

HEARING SCHEDULE:

Trial Date: _____ Next Hearing: _____ Type of Hearing: _____

*Withdrawal Hearing Date: _____

***(MUST BE TWO FULL WORKING DAYS FROM IDENTIFICATION OF CONFLICT IF TRIAL DATE HAS BEEN SET. AGENCY MUST NOTIFY PA AND CO-DEFENDANT COUNSEL.)**

LOCATION OF DISCOVERY:

PA's Office Agency will forward to new counsel Other _____

Request for credit/debit: _____

This form filled out by: _____ Date: _____

APPROVED BY: _____ Date: _____

OPD USE ONLY

OPD REASSIGNED TO: _____ INITIALS: _____ DATE: _____

FAX Interoffice Mail

ATTACHMENT F

[Agency] Persistent Offender (593) Monthly Case Report

Client Name: _____

Cause No.: _____

Month/Year: _____

Attorney(s): _____

Week (Dates)	Attorney (1)	Attorney (2) (if assigned)	Total Atty.	Invest	Social Wkr.	Paralegal	Total Support	Total Week	Total to Date
/ to /									
/ to /									
/ to /									
/ to /									
/ to /									
TOTAL									

NOTE: 12.1 hours = 1.00 credit

Abbreviations must be used to categorize attorney hours:

- CC = Contact with Client
- R = Legal Research
- Ptr = Pretrial Hearing
- Tr = Trial
- S = Sentencing/Disposition
- CP = Case Prep
- C = Confer with attorney/investigator/social worker/paralegal
- N/A = No second attorney assigned

ATTACHMENT G

King County Superior Court Drug Diversion Court

The King County Office of the Public Defender (OPD) has responsibility for ensuring dedicated defense services for the King County Superior Court Drug Diversion Court (DDC). Through a proposal process, the Associated Counsel for the Accused (ACA) defense agency is appointed to provide legal services to DDC defendants and, as such, has agreed to the following scope of work.

I. MISSION & GOALS

The DDC mission is to combine the resources of the criminal justice system, drug and alcohol treatment and other community service providers to compel the substance-abusing offender to address his or her substance abuse problem by providing an opportunity for treatment and holding the offender strictly accountable.

Goals of DDC program:

- A. Reduce substance use and related criminal activity.
- B. Enhance community safety.
- C. Reduce reliance on incarceration for non-violent drug dependant offenders.
- D. Hold drug dependent offenders accountable for their actions and decisions.
- E. Integrate substance abuse treatment with criminal justice case processing.
- F. Provide resources and support to assist the drug dependent offender in the acquisition of skills necessary for the maintenance of sobriety.
- G. Reduce the impact of drug related cases on criminal justice resources.
- H. Reward positive life changes while maintaining accountability for negative conduct.

The goal for ACA is to provide specialized legal defense services to work within the DDC to divert court eligible defendants. ACA shall be committed to advocating a treatment plan and support network that promotes the client's success and graduation in DDC.

II. STAFFING REQUIREMENTS

ACA will staff the DDC with 4.20 FTE attorneys for the period January 1, 2008 through December 31, 2008, and as according to Attachment B, 2008 Calendar Attorney and Staff List, of the ACA Contract.

- A. ACA shall assign a lead attorney who is experienced in working with eligible defendants to the DDC for a period of two years to assure consistency of experienced staff. Attorneys shall prepare cases for each calendar, including interviewing defendants in jail prior to their court appearance.

- B. ACA commits to assigning attorneys for a minimum of six months, structuring rotation in a timely manner that has the least negative impact to the DDC. This will ensure that the DDC has trained attorneys ready to practice in the DDC.
- C. In the event the assigned attorneys are not able to continue the assignment to the DDC (e.g. due to illness, resignation, personal issues), ACA will provide timely notification to the DDC and assign DDC trained attorneys to replace them.
- D. In the event that a dispute arises and the lead or back up attorneys do not fully discharge their duties in a professional manner, the DDC judge and coordinator/manager will speak first to the attorney(s) and their supervisor to resolve any disagreement and if that does not yield resolution, the ACA Managing Director will be notified and asked to intervene. If the matter is not resolved between the DDC judge and ACA, OPD will be notified to assist in dispute resolution.
- E. ACA commits to a minimum 30-day transition period when the lead attorney is leaving DDC practice.
- F. ACA shall provide 0.42 FTE Supervisor and 0.80 FTE Professional Support Staff each month for the period January 1, 2008 through December 31, 2008 for the DDC attorneys.

III. PROTOCOLS

- A. The role of ACA defense attorneys in DDC is to ensure the defendant's legal rights are protected while encouraging the client's full participation in the program. ACA defense attorneys shall:
 - 1. Participate fully as a DDC team member.
 - 2. Meet with potential DDC clients to evaluate their interest and amenability to the program, adhering to the eligibility criteria.
 - 3. Advise a client of their legal rights, legal options, and potential sentencing outcomes.
 - 4. Actively monitor client progress in the DDC and discusses the long-term benefits of a drug-free lifestyle.
 - 5. Participate in a cooperative manner at drug court hearings and meetings and promotes a unified DDC team approach.
 - 6. Adhere to DDC policies, rules and procedures, including reminding participants of their agreements, the DDC rules and mandates and the need to accept consequences for deviation from DDC mandates.
- B. ACA attorneys shall comply with the King County Drug Diversion Court Policy and Procedures Manual, March 16, 2004 edition or its successor, and will abide by the Rule of Professional Conduct of the Washington State Bar Association. The ACA attorneys (and those assigned to DDC) shall assure expeditious integration of referral and assessment to the DDC.
 - 1. ACA commits to the standards of Professional Responsibility for new assignments when a case with an existing attorney is transferred to DDC.

2. ACA commits to maintaining a referral process to assure expeditious referral from arraignment calendars.
 3. Clients who transfer into DDC with a private attorney or an attorney from another defender agency may continue to be represented by their attorney or agency. These clients may be transferred to ACA through proper protocol of withdrawal and substitution of counsel procedures.
 4. ACA commits to seeking funding or services to support DDC client/defendant needs. This includes but is not limited to access to housing, treatment services, and/or transportation assistance.
- C. ACA and its attorneys shall continue the assignment on cases of DDC defendants through the length of jurisdiction (up to two years) and appear for all hearings.
- D. Conflicts in the client/attorney assignment to ACA will be identified and addressed in the following manner: If the attorney identifies the conflict and the defendant wishes to proceed with ACA, the ACA attorney will obtain a waiver from the client. When necessary, the ACA attorney will examine it with the defendant and provide timely notification to the DDC, to OPD, and to the defendant.

IV. METHOD OF COMPENSATION

ACA shall be reimbursed monthly according to Attachment C, Payment Schedule, Calendar Staffing, of Exhibit V of this Contract.

V. REPORTING

- A. ACA and its staff shall participate in future and ongoing evaluation efforts of OPD and the DDC and by affiliation with researchers. Required data may include output data (e.g., number of hearings, referrals, diversions, etc.) as well as outcomes data (e.g. recidivism), affirming that the data will not allow for identification of the defendants.
- B. ACA shall complete a monthly client tracking document in the format below, and submit it to OPD by the tenth working day of the subsequent month.

King County Superior Court Drug Diversion Court Report
Associated Counsel for the Accused

Month: _____

Case Number	Last Name	First Name	Last Name	First Name	Date of (as per) trial, hearing, transfer	Disposition	File Close date	Charge/Case Types						Hours			
								At Filing	At Disposition	Total Attorney	Invest.	Social Worker	Paralegal		Other Staff		

*Primary Attorney indicates the agency-assigned attorney who performed primary case management.

ATTACHMENT H

District Court Mental Health Court

The King County Office of Public Defense (OPD) has responsibility for ensuring dedicated defense services for the King County District Court Mental Health Court (MHC). Through a proposal process, the Associated Counsel for the Accused (ACA) defense agency is appointed to provide legal services to MHC defendants and, as such, has agreed to the following scope of work.

I. GOAL

To provide specialized legal defense services to work within the MHC to divert defendants who are mentally ill or developmentally disabled and defendants who have a co-occurring disorder (mental illness and chemical abuse) out of jail and into treatment.

ACA attorneys and staff assigned to the MHC shall subscribe to a "defendant based" approach and endorse the MHC goals, philosophy, and principles, including working collaboratively with the MHC team, KCDC Probation, and the ongoing development of the court.

II. STAFFING REQUIREMENTS

- A. ACA will staff the MHC with 1.50 FTE attorneys for the period January 1, 2008 through December 31, 2008, and as according to Attachment B, 2008 Calendar Attorney and Staff List, of the ACA Contract.
1. ACA shall assign a lead attorney who is experienced in working with mentally ill misdemeanants to the MHC for a period of two years to assure consistency of experienced staff. The lead attorney will spend the morning preparing for the afternoon MHC calendar, including interviewing defendants in jail prior to their court appearance on the afternoon calendar.
 2. ACA commits to assigning the "back up" attorney for a minimum of six months, structuring rotation in a timely manner that has the least negative impact to the MHC. This will ensure that the MHC has trained attorneys ready to practice in the MHC. The back up attorney will be responsible for the Monday and Friday morning jail calendars. Both the back up and the lead attorneys should be able to do contested competency hearings.
 3. In the event the assigned attorneys are not able to continue the assignment to the MHC (e.g. due to illness, resignation, personal issues), ACA will provide timely notification to the MHC as well as assigning trained attorneys to the MHC.
 4. In the event that a dispute arises and the lead or back up attorneys do not fully discharge their duties in a professional manner, the MHC judge and coordinator/manager will speak first to the attorney(s) to resolve any disagreement and if that does not work, the ACA director will be notified and asked to intervene.
 5. ACA commits to a minimum 30-day transition period when the lead attorney is leaving MHC practice.
 6. ACA shall provide 0.15 FTE Supervisor each month for the period January 1, 2008 through December 31, 2008 for the MHC attorneys.

- B. ACA will also staff the MHC each month with 1.00 FTE social worker.
 - 1. The social worker will be actively involved in newly identified referrals to MHC, providing substantial knowledge and perspective on the case as well as more informed decisions earlier in the process. This supports the MHC goal of early and active intervention.
 - 2. ACA commits to a minimum 30-day transition period when the social worker is leaving MHC practice.

III. PROTOCOLS

- A. ACA and its attorneys shall address all hearings as defined in RCW 10.77 for MHC defendants, and will abide by the Rule of Professional Conduct of the Washington State Bar Association. The ACA attorneys (and those assigned to MHC) shall assure expeditious integration of referral and assessment to the MHC.
 - 1. ACA commits to the standards of Professional Responsibility for new assignments when a case with an existing attorney is transferred to MHC.
 - 2. ACA commits to maintaining a referral process to assure expeditious referral from arraignment calendars.
 - 3. Clients who transfer into MHC with a private attorney or an attorney from another defender agency may continue to be represented by their attorney or agency. These clients may be transferred to ACA through proper protocol of withdrawal and substitution of counsel procedures.
 - 4. ACA commits to seeking funding or services to support MHC client/defendant needs. This includes but is not limited to access to housing, treatment services, and/or transportation assistance.
- B. ACA and its attorneys shall continue the assignment on cases of MHC defendants through the length of jurisdiction (up to two years) and appear for all hearings.
- C. Conflicts in the client/attorney assignment to ACA will be identified and addressed in the following manner: If the attorney identifies the conflict and the defendant wishes to proceed with ACA, the ACA attorney will obtain a waiver from the client. When necessary, the ACA attorney will examine it with the defendant and provide timely notification to the MHC, to OPD, and to the defendant.

IV. REPORTING

- A. ACA and its staff shall participate in future and ongoing evaluation efforts of OPD and the MHC. Required data may include output data (e.g., number of hearings, referrals, diversions, etc.) as well as outcomes data (e.g. recidivism), affirming that the data will not allow for identification of the defendants.
- B. ACA shall complete a monthly client tracking document in the format below, and submit it to OPD by the tenth working day of the subsequent month.

16404

Attachment B

King County Contract No. D37885D
Federal Taxpayer ID No. 91-1392873

Department/Division Community and Human Services/Office of the Public Defender
Agency Northwest Defenders Association
Project Title Public Defense Legal Services
Contract Amount \$4,980,393 Fund Code 000000010
Contract Period From: January 1, 2008 To December 31, 2008

KING COUNTY AGENCY SERVICES CONTRACT – 2008

THIS CONTRACT is entered into by KING COUNTY (the "County"), and Northwest Defenders Association, whose address is 1111 Third Avenue, Suite 200, Seattle, WA 98101, (the "Agency").

WHEREAS, the County desires to have legal services, as described in the Contract, performed for indigent persons legally entitled to appointed counsel in King County courts and as authorized by Ordinance No. 15652; and

WHEREAS, the Agency is a nonprofit law firm, incorporated under the Washington Nonprofit Corporation Code, within the meaning of Section 501(c)(3) of the Internal Revenue Code, organized and operated exclusively for the purpose of providing court-appointed legal services to indigent persons; and

WHEREAS, the County and the Agency agree that these legal services are provided by an independent contractor non-profit corporation, possessing all of the rights, duties and obligations that are possessed under Washington State law and applicable Federal laws for an independent contractor service provider; and

WHEREAS, the County and the Agency agree that any and all funds provided pursuant to this Contract are provided for the sole purpose of provision of legal services to indigent persons assigned to the Agency by the County Office of The Public Defender (OPD) or the courts of King County.

NOW THEREFORE, in consideration of payments, covenants, and agreements hereinafter mentioned, to be made and performed by the parties hereto, the parties covenant and do mutually agree as follows:

I. SCOPE OF SERVICES

The Agency shall provide services and comply with the requirements set forth hereinafter and in the following attached exhibits, which are incorporated herein by reference:

This form is available in alternate formats for people with disabilities upon request.

- | | | |
|-------------------------------------|--|--------------------------------|
| <input checked="" type="checkbox"/> | <u>Certificate of Insurance/Endorsements</u> | Attached hereto as Exhibit I |
| <input checked="" type="checkbox"/> | <u>Personnel Inventory Report</u> | Attached hereto as Exhibit II |
| <input checked="" type="checkbox"/> | <u>Affidavit of Compliance</u> | Attached hereto as Exhibit III |
| <input checked="" type="checkbox"/> | <u>504/ADA Assurance of Compliance</u> | Attached hereto as Exhibit IV |
| <input checked="" type="checkbox"/> | <u>Public Defense Legal Services</u> | Attached hereto as Exhibit V |

II. DURATION OF CONTRACT

This Contract shall commence on the 1st day of January 2008, and shall terminate on the 31st day of December 2008 ("Contract Term"), unless terminated earlier, pursuant to the terms and conditions of the Contract. This Contract may be extended by agreement of the parties for a period of up to three months in order to complete negotiations and/or receive necessary approval of a subsequent year contract. An amendment to extend the contract duration may reflect adjustments to payment and casework schedule reflective of planned changes for subsequent year.

III. COMPENSATION AND METHOD OF PAYMENT

- A. The County shall pay the Agency for satisfactory performance of the services and requirements specified in this Contract, payable in the following manner:

As defined in Exhibit V, Section IV, for Public Defense Legal Services.

- B. The Agency shall submit all outstanding reports within 20 days of the date this Contract terminates. If any of the Agency's reports which are due to the County are not submitted by the day specified in this subsection, the County may withhold payment to the Agency until such time as reports are submitted and approved.

IV. OPERATING BUDGET

The funds provided by the County to the Agency pursuant to the terms of this Contract are solely for expenses that are directly and legitimately related to the performance of the provisions of this Contract. In the event the County, determines that funds paid pursuant to this Contract were expended for any purposes other than those set forth in this Contract, such expenditure shall constitute a material breach of this Contract. Income and expenses, including prorated overhead costs, for Sexually Violent Predator cases and any other services funded by the State DSHS shall be reported and traceable in a method consistent with accounting standards noted below. If the Agency receives any revenue from any other source, the costs paid, including prorated overhead, for work done with that revenue shall be reported and traceable according to the accounting standards noted below.

V. INTERNAL CONTROL AND ACCOUNTING SYSTEM

The Agency shall establish and maintain a system of accounting and internal controls that comply with generally accepted accounting principles and financial reporting standards applicable to publicly supported not-for-profit corporations as prescribed by the Financial Accounting Standards Board.

VI. MAINTENANCE OF RECORDS

- A. The Agency shall maintain accounts and records, including personnel, property, financial, and programmatic records and other such records as may be deemed necessary by the County to ensure proper accounting for all Contract funds and compliance with this Contract.
- B. These records shall be maintained for a period of six years after termination hereof unless permission to destroy them is granted by the Office of the Archivist in accordance with Revised Code of Washington (RCW) Chapter 40.14.
- C. The Agency shall inform the County in writing of the location, if different from the Agency address listed on page one of this Contract, of the aforesaid books, records, documents and other evidence and shall notify the County in writing of any changes in location within ten working days of any such relocation.

VII. AUDITS

- A. The Agency shall have an independent audit, conducted by a certified public accountant, of its financial statement and condition, which shall comply with generally accepted auditing standards for not-for-profit organizations as prescribed by the American Institute of Certified Public Accountants. The independent auditor's report shall include a management letter listing any reportable conditions or internal control weaknesses, or stating that no reportable conditions or control weaknesses were noted. The auditor's report shall include a copy of the Agency's management representation letter. Any independent auditor hired by the Agency to fulfill the Contract audit requirements must agree to provide access to audit working papers if requested by the County.
- B. The Agency shall provide a copy of the audit report to each County division providing financial assistance to the Agency no later than the last business day of August. The Agency fiscal year shall be the same as a calendar year. The Agency shall provide to the County its response and corrective action plan for all findings and reportable conditions contained in its audit. The Agency shall provide the County with a copy of its IRS Form 990 (Return of Organization Exempt from Tax) when it is filed with the IRS.
- C. The Agency's annual financial statements shall be prepared recognizing all Agency fund accounts at the end of the Contract Term.
- D. Any and all accounts must be invested in a fiscally prudent fashion under the non-profit corporation law of Washington and applicable Federal laws. Prepayments, as noted in Exhibit V, Section IV, J shall be invested in a cash equivalent account, defined as a highly liquid, short term investment with little risk of loss in value.
- E. Additional federal and/or state audit or review requirements may be imposed on the County, and to the extent that such requirements relate to funding that is passed on to the Agency, the Agency shall be required to comply with any such requirements. The County shall notify the Agency when requirements from funders are issued to the County.

VIII. EVALUATIONS AND INSPECTIONS

- A. Upon reasonable notice, the Agency shall provide right of access to its facilities, including those of any subcontractor, to the County, the state, and/or federal agencies

or officials at all reasonable times for the purpose of monitoring and evaluating the services provided under this Contract. The County shall give advance notice to the Agency in the case of fiscal audits to be conducted by the County.

- B. The records and documents with respect to all matters covered by this Contract, not including entire individual personnel files but may include specific requested documentation, shall be subject to inspection, review, or audit by the County (and to the extent Contract funds paid by the County are derived from federal and/or state sources, also by federal and/or state officials so authorized by law) during the Contract Term and six years thereafter, unless a longer record retention period is required by law and in such case, the right of inspection shall extend until the end of the applicable retention period.
- C. The Agency agrees to cooperate with the County or its agent in the evaluation of the Agency's performance under this Contract and to make available all information reasonably required by any such evaluation process or ongoing reporting requirements established by the County. The results and records of said evaluations and reports shall be maintained and disclosed in accordance with RCW Chapter 42.17.

IX. CORRECTIVE ACTION

The County and Agency agree that when operational or performance issues arise in the course of providing the services of this Contract, a resolution of an issue or concern will be attempted at the lowest administrative level possible, although generally contact with the Agency shall include the managing director.

If the County determines that a performance concern has not been rectified at a less formal level and/or that a breach of contract has occurred, that is, the Agency has failed to comply with any terms or conditions of this Contract or the Agency has failed to provide in any manner the work or services agreed to herein, and if the County deems said breach to warrant written corrective action, the following sequential procedure shall apply:

- A. The County shall notify the Agency in writing of the nature of the breach;

The Agency shall respond in writing within three working days of its receipt of such notification, which response shall indicate the steps being taken to correct the specified deficiencies. The corrective action plan shall specify the proposed completion date for bringing the Agency into Contract compliance, which date shall not be more than 30 days from the date of the County's approval of the Agency's plan, unless the County, at its sole discretion, specifies in writing an extension in the number of days to complete the corrective actions;
- B. The County shall notify the Agency in writing of the County's determination as to the sufficiency of the Agency's corrective action plan within ten days of receipt, or longer with written notification to the Agency. The determination of sufficiency of the Agency's corrective action plan shall be at the sole discretion of the County, provided that the County shall take into consideration the reasonableness of the proposed corrective action in light of the breach;
- C. In the event that the Agency does not respond within the appropriate time with a corrective action plan, or the Agency's corrective action plan is determined by the County to be insufficient, the County may commence termination of this Contract in whole or in part pursuant to Section XI.A. if the breach is material;

- D. In addition to and not in lieu of any of its other contractual or legal rights or remedies, the County, in its sole discretion, may withhold any payment owed the Agency hereunder or prohibit the Agency from incurring additional financial obligations, except to the extent such obligations are required by court order or deemed by the County as necessary for the competent and adequate representation of indigent persons assigned to the Agency, until the County is satisfied that corrective action has been taken or completed; and
- E. The County may choose to use corrective action in response to any type of breach by the Agency. The choice of corrective action or termination under Section XI for a material breach is within the County's sole discretion. Nothing herein shall be deemed to affect or waive any rights the parties may have pursuant to Section XI. Nor shall the exercise of any right within this section be deemed to be a breach of this Contract by the County.

X. ASSIGNMENT/SUBCONTRACTING

- A. The Agency shall not assign or subcontract any portion of the Legal Services, as defined in Exhibit V, supervision or training which is provided under this Contract or transfer or assign any claim arising pursuant to this Contract without the written consent of the County. Said consent must be sought in writing by the Agency not less than 15 days prior to the date of any proposed assignment. The definition of training, within this subsection only, does not include CLE's. The Agency may contract for training services up to a cumulative amount of \$10,000.00 in a contract year, without seeking consent of the County. These excluded contracts and CLE costs must be reported to the County, as noted in Paragraph X. B. of this Section.
- B. The Agency shall keep all records of any contracts or purchases of goods or services related to this Contract. The Agency shall be required to report these expenditures to the County and the original records may be subject to audit at the County's request.

XI. TERMINATION

- A. The County may terminate this Contract, in whole or in part, upon seven days advance written notice in the event: (1) the Agency breaches any material duty, obligation, or service required pursuant to this Contract, (2) the Agency or any of its officers, directors, employees, subcontractors, agents or representatives engages in the misappropriation or mismanagement of Contract funds or the fraudulent disbursement of Contract funds, (3) the Agency or any of its officers, directors, agents, representatives or designees makes a material misrepresentation regarding the Agency, its finances and/or scope of activities to its independent accountant, auditor, the County, and/or any other agencies or instrumentalities of the federal, state or local government or commits any act or omission that jeopardizes the Agency's tax-exempt status under Code section 501(c)(3) or (4) the duties, obligations, or services required herein become impossible, illegal, or not feasible. The County's termination notice does not bar the Agency from seeking injunctive relief or any other equitable relief available under current Washington State law.

If the Contract is terminated by the County pursuant to (1), (2), or (3) in the first paragraph of XI. A., the Agency shall be liable for damages, including any additional reasonable costs of procurement of similar services from another source.

In the event the County terminates the Contract due to (1), (2), or (3) in the first paragraph of XI. A., or any act or omission which jeopardizes the Agency's tax-exempt

status under IRS Code Section 501(c)(3), then subject to the provisions of this Section, the Agency shall return to the County any funds misappropriated and paid to the Agency by the County under the current Contract and from any available source, including funds from a prior contract. In addition, the Agency shall return such funds determined by the County to be reasonable and necessary to provide legal services, as defined in Exhibit V, for the balance of the Contract term, or until the County is able to obtain a successor agency to provide such services, whichever period is less. This provision and the obligations contained herein shall survive the termination or expiration of this Contract.

The Agency may terminate this Contract, in whole or in part, prior to the end of the Contract Term, by providing the County seven days advance written notice, in the event the County commits any material breach of this Contract caused by non-payment or partial termination of caseload area or geographic location of services by the County without a negotiated amendment.

B. In the event of the termination of this Contract the Agency shall remit any unexpended balance of funds paid, including prepaid funds for cases assigned and not completed, less the amount the County and the Agency agree shall be necessary to enable the Agency to deliver services in those cases notwithstanding the termination. Nothing herein shall limit, waive, or extinguish any right or remedy provided by this Contract or law that either party may have in the event that the obligations, terms, and conditions set forth in this Contract are breached by the other party.

C. If County expected or actual funding is withdrawn, reduced, or limited in any way prior to the termination date set forth above in Section II, the County may, upon 15 days written notification to the Agency, terminate this Contract in whole or in part.

If the Contract is terminated as provided in this Subsection: (1) the County shall be liable only for payment in accordance with the terms of this Contract for services rendered prior to the effective date of termination; and (2) the Agency shall be released from any obligation to provide such further services pursuant to the Contract as are affected by the termination.

D. This Contract may be terminated for convenience by either party, prior to the date specified in Section II, by providing 60 days advance written notice of the termination.

XII. DISPUTE RESOLUTION

Agency disputes pertaining to County decisions regarding Contract compliance issues shall be made in writing to The Public Defender. The written dispute shall include the decision being questioned and the point on which the dispute is made. This is a non-exclusive remedy.

The Public Defender shall make a determination decision and respond in writing to the Agency within 15 days of receipt. If the Agency wishes to appeal The Public Defender decision, an additional letter indicating all points of the dispute resolution process to date shall be sent to the Director of the Department of Community and Human Services. The Department Director shall make a final determination and respond in writing to the Agency within 30 days of the Department Director's Office receipt of the appeal notice from the Agency.

Nothing herein shall impair the procedure of Section IX above nor the ability of either party to terminate this Contract as set forth in Section XI above.

XIII. FUTURE SUPPORT

- A. The County makes no assurance or commitment to the Agency for a subsequent contract or extension of the effective dates of the Contract for the services contracted for herein. Funding or obligation under this Contract beyond the current appropriation year is conditional upon appropriation by the County Council of sufficient funds to support the activities described in the Contract. Should such appropriation not be approved, this Contract shall terminate at the close of the current appropriation year.
- B. Should the County or Agency terminate this Contract or not renew this Contract for services in a subsequent period, the County shall work with the Agency to provide appropriate transition planning for assigned Agency clients to ensure their defense is not jeopardized by actions of the Agency or the County.

XIV. HOLD HARMLESS AND INDEMNIFICATION

- A. In providing services under this Contract, the Agency is an independent contractor, and neither it nor any of its officers, directors, employees, subcontractors, agents, or representatives are employees of the County for any purpose. The Agency shall be responsible for all federal and/or state tax, industrial insurance, and Social Security liability that may result from the performance of and compensation for these services and shall make no claim of career service or civil service rights which may accrue to a County employee under state or local law.

The County assumes no responsibility for the payment of any compensation, wages, benefits, or taxes, by, or on behalf of the Agency, its employees, and/or others by reason of this Contract. The Agency shall protect, indemnify, and save harmless the County, its officers, officials, agents, and employees from and against any and all claims, costs, and/or losses whatsoever occurring or resulting from (1) the Agency's failure to pay any such compensation, wages, benefits, or taxes, and/or (2) the supplying to the Agency of work, services, materials, or supplies by Agency employees or other suppliers in connection with or support of the performance of this Contract.

- B. The Agency further agrees that it is financially responsible for and shall repay the County all amounts determined by a fiscal audit exception which occur due to the negligence, intentional act, and/or failure, for any reason, to comply with the terms of this Contract by the Agency, its officers, directors, employees, subcontractors, agents, and/or representatives.
- C. Should it become necessary to institute legal action in order to recoup any funds due and owing to the County or the Agency pursuant to any of the terms of this Contract, the non-prevailing party agrees it is financially responsible and liable for the prevailing attorneys' fees and costs. Each party's duty to repay shall not be diminished or extinguished by the prior termination of the Contract pursuant to any provision hereof.
- D. The Agency shall protect, defend, indemnify, and save harmless the County, its officers, officials, employees, and agents from any and all costs, claims, judgments, and/or awards of damages, arising out of, or in any way resulting from, the negligent acts or omissions of the Agency, its officers, directors, employees, subcontractors, agents, and/or representatives in performance and/or non-performance of its obligations under this Contract. The Agency agrees that its obligations under this subparagraph extend to any claim, demand, and/or cause of action brought by, or on behalf of, any of its employees or agents. For this purpose, the Agency, by mutual

negotiation, hereby waives, as respects the County only, any immunity that would otherwise be available against such claims under the Industrial Insurance provisions of Title 51 RCW. In the event the County incurs any judgment, award, and/or cost arising therefrom including attorneys' fees to enforce the provisions of this article, all such fees, expenses, and costs shall be recoverable from the Agency.

- E. The County shall protect, defend, indemnify, and hold harmless the Agency, its officers, directors, employees, agents, and representatives from any and all costs, claims, judgments, and/or awards of damages, arising out of, or in any way resulting from, the negligent acts or omissions of the County, its officers, officials, employees, or agents. The County agrees that its obligations under this subparagraph extends to any claim, demand, and/or cause of action brought by, or on behalf of, any of its employees or agents. For this purpose, the County, by mutual negotiation, hereby waives, as respects the Agency only, any immunity that would otherwise be available against such claims under the Industrial Insurance provisions of Title 51 RCW. In the event the Agency incurs any judgment, award, and/or cost arising therefrom including attorneys' fees to enforce the provisions of this article, all such fees, expenses, and costs shall be recoverable from the County.

Claims shall include, but not be limited to, assertions that the use or transfer of software, book, document, report, film, tape, or sound reproduction or material of any kind, delivered hereunder, constitutes an infringement of any copyright, patent, trademark, trade name, and/or otherwise results in unfair trade practice.

- F. To the extent that an Agency subcontractor fails to satisfy its obligation to defend and indemnify the County as detailed in Section XVIII.B. of this Contract, the Agency shall protect, defend, indemnify, and hold harmless the County, its officers, employees and agents from any and all costs, claims, judgments, and/or awards or damages arising out of, or in any way resulting from, the negligent act or omissions of the Agency's subcontractor, its officers, employees, and/or agents in connection with or in support of this Contract.
- G. Nothing contained within this provision shall affect and/or alter the application of any other provision contained within this Contract.

XV. INSURANCE REQUIREMENTS

- A. By the date of execution of this Contract, the Agency shall procure and maintain for the duration of this Contract, insurance against claims for injuries to persons or damages to property which may arise from, or is in connection with, the performance of work hereunder by the Agency, its agents, representatives, employees, and/or subcontractors. The costs of such insurance shall be paid by the Agency or subcontractor. The Agency must furnish separate certificates of insurance and policy endorsements for each subcontractor as evidence of compliance with the insurance requirements of this Contract. The Agency is responsible for ensuring compliance with all of the insurance requirements stated herein. Failure by the Agency, its agents, employees, officers, and or subcontractors, to comply with the insurance requirements stated herein shall constitute a material breach of this Contract.

For All Coverages: Each insurance policy shall be written on an "occurrence" form; except that insurance on a "claims made" form may be acceptable with prior County approval.

If coverage is approved and purchased on a "claims made" basis, the Agency warrants continuation of coverage, either through policy renewals or the purchase of an extended discovery period, if such extended coverage is available, for not less than three years from the date of Contract termination, and/or conversion from a "claims made" form to an "occurrence" coverage form.

By requiring such minimum insurance, the County shall not be deemed or construed to have assessed the risks that may be applicable to the Agency under this Contract. The Agency shall assess its own risks and, if it deems appropriate and/or prudent, maintain greater limits and/or broader coverage.

Nothing contained within these insurance requirements shall be deemed to limit the scope, application and/or limits of the coverage afforded by said policies, which coverage shall apply to each insured to the full extent provided by the terms and conditions of the policy(s). Nothing contained within this provision shall affect and/or alter the application of any other provision contained within this Contract.

B. Minimum Scope of Insurance

Coverage shall be at least as broad as:

1. General Liability:

Insurance Services Office form number (CG 00 01 Ed. 11-88) covering **COMMERCIAL GENERAL LIABILITY**.

2. Professional Liability:

Professional Liability, Errors, and Omissions coverage. In the event that services delivered pursuant to this Contract either directly or indirectly involve or require professional services, Professional Liability, Errors, and Omissions coverage shall be provided. "Professional Services", for the purpose of this Contract section, shall mean any services provided by a licensed professional or those services that require a professional standard of care.

3. Automobile Liability:

In the event that services delivered pursuant to this Contract require the use of a vehicle or involve the transportation of clients by Agency personnel in Agency-owned vehicles or non-owned vehicles, the Agency shall provide evidence of the appropriate automobile coverage.

Insurance Services Office form number (CA 00 01 Ed. 12-90) covering **BUSINESS AUTO COVERAGE**, symbol 1 "any auto"; or the appropriate coverage provided by symbols 2, 7, 8, or 9.

4. Workers' Compensation:

Workers' Compensation coverage, as required by the Industrial Insurance Act of the State of Washington, as well as any similar coverage required for this work by applicable federal or "Other States" state law.

5. Stop Gap/Employers Liability:

Coverage shall be at least as broad as the protection provided by the Workers' Compensation policy Part 2 (Employers Liability) or, in states with monopolistic state funds, the protection provided by the "Stop Gap" endorsement to the general liability policy.

C. Minimum Limits of Insurance

The Agency shall maintain limits no less than, for:

1. General Liability: \$1,000,000 combined single limit per occurrence by bodily injury, personal injury, and property damage, and for those policies with aggregate limits, a \$2,000,000 aggregate limit.
2. Professional Liability, Errors, and Omissions: \$2,000,000 per claim and in the aggregate.
3. Automobile Liability: \$1,000,000 combined single limit per accident for bodily injury and property damage. Except if the transport of clients by Agency personnel is involved, then Risk Management shall review the appropriate amount of coverage.
4. Workers' Compensation: Statutory requirements of the state of residency.
5. Stop Gap/Employers Liability: \$1,000,000.

D. Deductibles and/or Self-insured Retentions

Any deductibles or self-insured retentions greater than \$10,000 must be declared to, and approved by, the County. The deductible and/or self-insured retention of the policies shall not apply to the Agency's liability to the County and shall be the sole responsibility of the Agency.

E. Other Insurance Provisions

The insurance policies required in this Contract are to contain, or be endorsed to contain, the following provisions:

1. Liability Policies Except Professional and Workers Compensation
 - a. The County, its officers, officials, employees, and agents are to be covered as additional insureds as respects liability arising out of activities performed by or on behalf of the Agency in connection with this Contract.
 - b. The Agency's insurance coverage shall be primary insurance as respects the County, its officers, officials, employees, and agents. Any insurance and/or self-insurance maintained by the County, its offices, officials, employees, or agents shall not contribute with the Agency's insurance or benefit the Agency in any way.
 - c. The Agency's insurance shall apply separately to each insured against whom claim is made and/or lawsuit is brought, except with respect to the limits of the insurer's liability.

2. All Policies

Coverage shall not be suspended, voided, canceled, reduced in coverage or in limits, except by the reduction of the applicable aggregate limit by claims paid, until after 45 days prior written notice has been given to the County.

F. Acceptability of Insurers

Unless otherwise approved by the County,

Insurance is to be placed with insurers with a Bests' rating of no less than A:VIII, or, if not rated with Bests, with minimum surpluses the equivalent of Bests' surplus size VIII.

Professional Liability, Errors, and Omissions insurance may be placed with insurers with a Bests' rating of B+VII. Any exception must be approved by King County.

If, at any time, the foregoing policies shall fail to meet the above minimum requirements the Agency shall, upon notice to that effect from the County, promptly obtain a new policy, and shall submit the same to the County, with appropriate certificates and endorsements, for approval.

G. Verification of Coverage

The Agency shall furnish the County certificates of insurance and endorsements required by this Contract. Such certificates and endorsements, and renewals thereof, shall be attached as exhibits to the Contract. The certificates and endorsements for each insurance policy are to be signed by a person authorized by that insurer to bind coverage on its behalf. The certificates and endorsements for each insurance policy are to be on forms approved by the County prior to the commencement of activities associated with the Contract. The County reserves the right to require complete, certified copies of all required insurance policies at any time.

H. Subcontractors

The Agency shall include all subcontractors as insureds under its policies or shall furnish separate certificates of insurance and policy endorsements from each subcontractor. Insurance coverages provided by subcontractors as evidence of compliance with the insurance requirements of this Contract shall be subject to all of the requirements stated herein.

XVI. NONDISCRIMINATION AND EQUAL EMPLOYMENT OPPORTUNITY

A. Nondiscrimination in Employment Provision of Services

During the Contract Term, neither the Agency nor any party subcontracting under the authority of this Contract shall discriminate or tolerate harassment on the basis of race, color, sex, religion, national origin, marital status, sexual orientation, age, or the presence of any sensory, mental, or physical disability in the employment or application for employment or in the administration or delivery of services or any other benefits under this Contract.

B. Equal Benefits to Employees with Domestic Partners

Pursuant to Ordinance 14823, King County's "Equal Benefits" (EB) ordinance, and related administrative rules adopted by the County Executive, as a condition of award of a contract valued at \$25,000 or more, the Contractor agrees that it shall not discriminate in the provision of employee benefits between employees with spouses, and employees with domestic partners during the performance of this Contract. Failure to comply with this provision shall be considered a material breach of this Contract, and may subject the Contractor to administrative sanctions and remedies for breach.

When the contract is valued at \$25,000 or more, the Contractor shall complete a Worksheet and Declaration form for County review and acceptance prior to Contract execution. The EB Compliance forms, Ordinance 14823 (which is codified at KCC Chapter 12.19), and related administrative rules are incorporated herein by reference. They are also available online at:
<http://www.metrokc.gov/procurement/services/eb.aspx>

C. Nondiscrimination in Subcontracting Practices

During the solicitation, award and term of this Contract, the Agency shall not create barriers to open and fair opportunities to participate in County contracts or to obtain or compete for contracts and subcontracts as sources of supplies, equipment, construction and services. In considering offers from and doing business with subcontractors and suppliers, the Agency shall not discriminate against any person on the basis of race, color, religion, sex, age, national origin, marital status, sexual orientation or the presence of any mental or physical disability in an otherwise qualified disabled person.

D. Compliance with Laws and Regulations

The Agency shall comply fully with all applicable federal, state and local laws, ordinances, executive orders and regulations that prohibit discrimination. These laws include, but are not limited to, KCC 12.17, RCW Chapter 49.60, Titles VI and VII of the Civil Rights Act of 1964, 42 U.S.C. 2000(a) et seq., the Americans with Disabilities Act, 42 U.S.C. 12101 et seq., and the Restoration Act of 1987. The Agency shall further comply fully with any affirmative action requirements set forth in any federal regulations, statutes or rules included or referenced in the Contract.

E. Small Business and Minority and Women Business Enterprise Opportunities

The County encourages the Agency to utilize small businesses, including Minority-owned and Women-owned Business Enterprises ("M/WBES") in County contracts. The County encourages the Agency to use the following voluntary practices to promote open competitive opportunities for small businesses, including M/WBES:

1. Attending a pre-bid or pre-solicitation conference, if scheduled by the County, to provide project information and to inform small businesses and other firms of contracting and subcontracting opportunities;
2. Placing all qualified small businesses, attempting to do business in King County, including M/WBES, on solicitation lists, and providing written notice of subcontracting opportunities to these firms capable of performing the work, including without limitation all businesses on any list provided by the County, in sufficient time to allow such businesses to respond to the written solicitations;

3. Breaking down total requirements into smaller tasks or quantities, where economically feasible, in order to permit maximum participation by small businesses, including M/WBEs;
4. Establishing delivery schedules, where the requirements of this Contract permit, that encourage participation by small businesses, including M/WBEs;
5. Providing small businesses, including M/WBEs that express interest with adequate and timely information about plans, specifications, and requirements of the Contract;
6. Using the services of available community organizations, contractor groups, local assistance offices, the County, and other organizations that provide assistance in the recruitment and placement of small businesses, including M/WBEs; and,
7. The Washington State Office of Minority and Women's Business Enterprises (OMWBE) can provide a list of certified M/WBEs. Contact OMWBE office at 360-753-9693 or on-line through the web site at www.wsdot.wa.gov/omwbe/.

F. Equal Employment Opportunity

The Agency shall implement and carry out the obligations in its Affidavit and Certificate of Compliance regarding equal employment opportunity, and all other requirements as set forth in the Affidavit and Certificate of Compliance.

G. Fair Employment Practices

King County Code Chapter 12.18 is incorporated by reference as if fully set forth herein and such requirements apply to this Contract. During the performance of this Contract, neither the Agency nor any party subcontracting under the authority of this Contract shall engage in unfair employment practices. It is an unfair employment practice for any:

1. Employer or labor organization to discriminate against any person with respect to referral, hiring, tenure, promotion, terms, conditions, wages or other privileges of employment;
2. Employment agency or labor organization to discriminate against any person with respect to membership rights and privileges, admission to or participation in any guidance program, apprenticeship training program, or other occupational training program;
3. Employers, employment agency, or labor organization to print, circulate, or cause to be printed, published or circulated, any statement, advertisement, or publication relating to employment or membership, or to use any form of application therefore, which indicates any discrimination unless based upon a bona fide occupation qualification;
4. Employment agency to discriminate against any person with respect to any reference for employment or assignment to a particular job classification;
5. Employer, employment agency or a labor organization to retaliate against any person because that person has opposed any practice forbidden by KCC

Chapter 12.18 or because that person has made a charge, testified or assisted in any manner in any investigation, proceeding or hearing initiated under the provisions of KCC Chapter 12.18;

6. Publisher, firm, corporation, organization or association printing, publishing or circulating any newspaper, magazine or other written publication to print or cause to be printed or circulated any advertisement with knowledge that the same is in violation of KCC Chapter 12.18.030.C., or to segregate and separately designate advertisements as applying only to men or women unless such discrimination is reasonably necessary to the normal operation of the particular business, enterprise or employment, unless based upon a bona fide occupational qualification;
7. Employer to prohibit any person from speaking in a language other than English in the workplace unless:
 - a. The employer can show that requiring that employees speak English at certain times is justified by business necessity, and
 - b. The employer informs employees of the requirement and the consequences of violating the rule.
8. If the Agency engages in unfair employment practices as defined above, remedies as set forth in KCC Chapter 12.18 may be applied.

H. Record-Keeping Requirements and Site Visits

The Agency shall maintain, for at least six years after completion of all work under this Contract, the following:

1. Records of employment, employment advertisements, application forms, and other pertinent data, records and information related to employment, and solicited applications for employment; and
2. Records, including written quotes, bids, estimates or proposals submitted to the Agency by all businesses responding to Agency solicitation, and any other information necessary to document the actual use of and payments to subcontractors and suppliers in this Contract, including employment records.

The County may visit upon reasonable notice, at any reasonable time, the site of the work and the Agency's office to review the foregoing records. The Agency shall provide every assistance requested by the County during such visits. In all other respects, the Agency shall make the foregoing records available to the County for inspection and copying any reasonable volume of documents upon request. If this Contract involves federal funds, the Agency shall comply with all record keeping requirements set forth in any federal rules, regulations or statutes included or referenced in this Contract and the Exhibits attached.

I. Sanctions for Violations

Any violation of the mandatory requirements of the provisions of this Section shall be a material breach of this Contract for which the Agency may be subject to damages, withhold of payment and any other sanctions provided for by this Contract and by applicable law.

J. Reporting

1. The Agency shall submit with this Contract a total Personnel Inventory Report providing employment data for minorities, females, and persons with disabilities.

Subject to the provisions of KCC Chapter 12.16.060, the Agency's Personnel Inventory Report shall be effective for two years after the date on which the report was submitted.

2. The Agency also shall submit an Affidavit of Compliance in the form provided by the County, demonstrating commitment to comply with the provisions of KCC Chapter 12.16 in accordance with Paragraph A of this Section.

The Agency shall complete the Affidavit of Compliance provided by the County and attach the original, notarized, completed form to this Contract. Subject to the provisions of KCC Chapter 12.16.060, the Agency's Affidavit of Compliance shall be effective for two years after the date on which the report was submitted.

If the Agency engages in unfair employment practices as defined above, remedies as set forth in KCC Chapter 12.18 shall be applied as well as any other remedies by law.

The Agency shall complete all reports and forms (including Department of Social and Health Services non-discrimination forms, where applicable) provided by the County and shall otherwise cooperate fully with the County in monitoring and assisting the Agency in providing nondiscriminatory programs.

XVII. SECTION 504 AND AMERICANS WITH DISABILITIES ACT

The Agency has completed a 504/ADA Self-Evaluation Questionnaire for all programs and services offered by the Agency (including any services not subject to this Contract), and has evaluated its services, programs and employment practices for compliance with Section 504 of the Rehabilitation Act of 1973, 29 U.S.C. 701 et seq. as amended ("504") and the ADA, 42 U.S.C. 12101 et seq. The Agency has completed, attached as an Exhibit to this Contract, and incorporated herein by reference a 504/ADA Assurance of Compliance.

XVIII. SUBCONTRACTS AND PURCHASES

- A. The Agency shall include the above Sections IV, V, VI, VII, VIII, XIII, XIV, XV, XVI, and XVII, in every subcontract or purchase agreement for services which relate to the subject matter of this Contract.
- B. The Agency agrees to include the following language verbatim in every subcontract, provider agreement, or purchase agreement for services which are the subject matter of this Contract:

"[Subcontractor] shall protect, defend, indemnify, and hold harmless King County, its officers, employees and agents from any and all costs, claims, judgments, and/or awards of damages arising out of, or in any way resulting from the negligent act or omissions of subcontractor, its officers, employees, and/or agents in connection with or in support of this Contract. Subcontractor expressly agrees and understands that King

County is a third party beneficiary to this Contract and shall have the right to bring an action against subcontractor to enforce the provisions of this paragraph."

XIX. CONFLICT OF INTEREST

- A. The Agency agrees that it will not willfully attempt to secure preferential treatment in its dealings with the County by offering any valuable consideration, thing of value or gift, whether in the form of services, loan, thing or promise, in any form to any County official or employee. The Agency acknowledges that if it is found to have violated the prohibition found in this paragraph, its current contracts with the County shall be cancelled and it shall not be able to bid on any County contract for a period of two years.
- B. The Agency acknowledges that for one year after leaving County employment, a former County employee may not have a financial or beneficial interest in a contract or grant that was planned, authorized, or funded by a County action in which the former County employee participated during County employment. Agency shall identify, at the time of offer, current or former County employees involved in the preparation of proposals or the anticipated performance of work if awarded the Contract. Failure to identify current or former County employees involved in this transaction may result in the County's denying or terminating this Contract. Before making an employment offer to a person who has less than a year separation from County employment, the Agency shall confirm with the person being tended the employment offer of their compliance with KCC Chapter 3.04 and this paragraph.
- C. Failure to comply with this Section XIX shall be a material breach of this Contract, and may result in termination of this Contract pursuant to Section XI and subject the Agency to the remedies stated therein, or otherwise available to the County at law or in equity.

XX. BOARD OF DIRECTORS

The Agency shall qualify at all times as a non-profit corporation under U.S.C., Subtitle A., Chapter 1, Subchapter F, Part 1, and Section 501(c)(3).

The Agency shall have an active, legally constituted board of directors in accordance with RCW Chapters 23B or 24 that shall be comprised of neither employees nor relatives of employees, officers or directors of the Agency, except as approved by the County under this Section. The Director may be an ex officio member of the Board of Directors. For the purposes of this Section, a relative is defined as a husband, wife, father, father-in-law, mother, mother-in-law, brother, brother-in-law, sister, sister-in-law, son-in-law, daughter-in-law, niece, nephew, grandparent, grandchild, uncle, aunt, child, child of domestic partner, and domestic partner. In addition, the relatives of a domestic partner shall be considered relatives to the same extent such relatives would be included in this Section, as if the employee and domestic partner were married. The Board of Directors shall meet regularly and fulfill all of the duties under applicable Washington State law and federal law.

The Board of Directors shall maintain a formal conflict of interest policy for Board members that complies with the applicable provisions of the Internal Revenue Code 501(c)(3) status, and addresses issues regarding gifts, financial gain, and improper use of position.

The Contract shall be reviewed and approved for Agency signature by the Agency's Board of Directors.

Each amendment to this Contract must be approved by the Agency's Board of Directors.

A. **Interests of Agency Management and Agency Board:**

The following shall be disallowed and shall be considered a conflict of interest without prior disclosure and approval of the County:

1. The Agency shall not employ an individual who is related to a director or assistant director of the Agency or an Agency Board member, either as an employee, contractor or through a corporation. This provision shall not apply when the total compensation paid to the individual is less than \$500 per annum.
2. The Agency shall not acquire or rent real and/or personal property owned or rented by either:
 - a. an employee or Board member of the Agency;
 - b. a relative of an employee or Board member of the Agency; or
 - c. a corporation in which an employee or Board member of the Agency, or a relative of such a person, has ownership.

B. Failure to comply with any provision of this Section XX shall constitute a material breach of this Contract.

XXI. MANAGING DIRECTOR OF AGENCY

The managing director of the Agency shall be an attorney licensed to practice law in the State of Washington. The managing director shall be a salaried employee of the Agency, subject to the authority and control of the Board of Directors of the Agency. The managing director of the Agency shall be responsible for receiving funds into program accounts or issuing financial documents, checks, or other instruments of payment for program costs provided pursuant to this Contract.

XXII. POLITICAL ACTIVITY PROHIBITED

No funds, materials, property, or services provided directly or indirectly under this Contract shall be used for any partisan political activity or to further the election or defeat of any candidate for public office.

XXIII. EQUIPMENT PURCHASE, MAINTENANCE, AND OWNERSHIP

- A. The Agency agrees that any equipment purchased with Contract funds at a cost of \$5,000 per item or more, and identified in an exhibit as reimbursable, is upon its purchase or receipt the property of the County, and/or federal, and/or state government as specified in the exhibit.
- B. The Agency shall be responsible for all such equipment, including the proper care and maintenance.
- C. The Agency shall ensure that all such equipment will be returned to the appropriate government agency, whether federal, state or County, upon written request of the County.

- D. The Agency shall admit County staff to the Agency's premises for the purpose of marking such equipment with appropriate government property tags.
- E. The Agency shall establish and maintain inventory records and transaction documents (purchase requisitions, packing slips, invoices, receipts) of equipment purchased with Contract identified funds.

XXIV. NOTICES

Whenever this Contract provides for notice to be provided by one party to another, such notice shall be:

- A. In writing; and

Directed to the managing director of the Agency, the President of the Board of Directors of the Agency, The Office of the Public Defender, and the director of the Department of Community and Human Services.

- B. Any due date within which a party must take some action shall be computed according to CR 6(a). If notice is provided by US Post, CR 5(b)(2)(A) shall apply to determine the date of service.

XXV. PROPRIETARY RIGHTS

The parties to this Contract hereby mutually agree that if any patentable or copyrightable material or article is the product of work performed for the County as described herein, all rights accruing from such material or article shall be the sole property of the Agency. The Agency agrees to and does hereby grant to the County, irrevocable, nonexclusive, and royalty-free license to use, according to law, any material or article and use any method that may be developed as part of the work under this Contract.

The foregoing products license shall not apply to existing training materials, consulting aids, checklists, and other materials and documents of the Agency which are used in the performance of this Contract.

XXVI. CONTRACT AMENDMENTS

Either party may request changes to this Contract. Proposed changes which are mutually agreed upon shall be incorporated by written amendments to this Contract.

XXVII. KING COUNTY RECYCLED PRODUCT PROCUREMENT POLICY

The Agency shall use recycled paper for the production of all printed and photocopied documents related to the fulfillment of this Contract and shall ensure that, whenever possible, the cover page of each document printed on recycled paper bears an imprint identifying it as recycled paper. All Court document production shall be covered by Court rules.

If the cost of recycled paper is more than 15 percent higher than the cost of non-recycled paper, the Agency may notify the Contract Administrator, who may waive the recycled paper requirement.

The Agency shall use both sides of paper sheets for copying and printing and shall use recycled/recyclable products wherever practical in the fulfillment of this Contract.

XXVIII. SERVICES PROVIDED IN ACCORDANCE WITH LAW AND RULE AND REGULATION

The Agency and any subcontractor agree to abide by all of the laws of the State of Washington that are applicable to their business and the substance of the legal services that are the subject of this Contract. The Agency and any subcontractors also agree to abide by all Rules of Professional Conduct governing attorney conduct and to abide by the requirements of the attorney-client privilege, as defined by Washington statutory law and common law.

In the event that there is a conflict between any of the language contained in any exhibit or attachment to this Contract, the language in the Contract shall have control over the language contained in the exhibit or the attachment, unless the parties affirmatively agree in writing to the contrary.

XXIX. CONFIDENTIALITY

The Agency agrees that information, records, and data collected in connection with this Contract shall be protected from unauthorized disclosure in accordance with applicable common law, state and federal law, including but not limited to attorney-client privilege. The County agrees that the King County Office of The Public Defender shall protect any information received from the Agency from unauthorized disclosure in accordance with applicable common law, state and federal law, including but not limited to attorney-client privilege.

The County, through the Office of The Public Defender, shall abide by any applicable law of privilege in monitoring the Agency's performance under this Contract.

XXX. COMPLIANCE WITH THE HEALTH INSURANCE PORTABILITY ACCOUNTABILITY ACT OF 1996

Terms used in this Section shall have the same meaning as those terms in the Privacy Rule, 45 CFR Parts 160 and 164.

A. Obligations and Activities of the Agency

1. The Agency agrees not to acquire, use, or disclose protected health information other than as permitted or required by law.
2. The Agency agrees to implement administrative, physical, and technical safeguards that reasonably and appropriately protect the confidentiality, integrity, and availability of the protected health information that it creates, receives, maintains, or transmits on behalf of the County as required by CFR Title 45, Section 164, Subpart C.
3. The Agency agrees to mitigate, to the extent practicable, any harmful effect that is known to the Agency of a use or disclosure of protected health information by the Agency in violation of the requirements of this Contract.
4. The Agency agrees to report in writing all unauthorized or otherwise improper disclosures of a client's protected health information or security incident to the County by the Agency within two days of the Agency knowledge of such event.
5. The Agency agrees to ensure that any agent, including a subcontractor, to whom it provides protected health information received from, or created or received by the Agency on behalf of the County, agrees to the same restrictions

and conditions that apply through this Contract to the Agency with respect to such information.

6. The Agency agrees to make available protected health information in accordance with 45 CFR § 164.524.
7. The Agency agrees to make available protected health information for amendment and incorporate any amendments to protected health information in accordance with 45 CFR § 164.526.
8. The Agency agrees to make internal practices, books, and records, including policies and procedures and protected health information, relating to the use and disclosure of protected health information received from, or created or received by the Agency on behalf of King County, available to the Secretary, in a reasonable time and manner for purposes of the Secretary determining King County's compliance with the Privacy Rule.
9. The Agency agrees to make available the information required to provide an accounting of disclosures in accordance with 45 CFR § 164.528.

B. Permitted Uses and Disclosures by Business Associate

The Agency may use or disclose protected health information to perform functions, activities, or services for, or on behalf of, King County as specified in this Contract, provided that such use or disclosure would not violate the Privacy Rule if done by King County or the minimum necessary policies and procedures of King County.

C. Effect of Termination

1. Except as provided in Paragraph C.2. of this Section, upon termination of this Contract, for any reason, the Agency shall return or destroy all protected health information received from King County, or created or received by the Agency on behalf of King County. This provision shall apply to protected health information that is in the possession of subcontractors or agents of the Agency. The Agency shall retain no copies of the protected health information.
2. In the event the Agency determines that returning or destroying the protected health information is infeasible, the Agency shall provide to King County notification of the conditions that make return or destruction infeasible. Upon notification that return or destruction of protected health information is infeasible, the Agency shall extend the protections of the Contract to such protected health information and limit further uses and disclosure of such protected health information to those purposes that make the return or destruction infeasible, for so long as the Agency maintains such protected health information.

XXXI. NO THIRD PARTY BENEFICIARIES

Except for the Parties to whom this Contract is assigned in compliance with the terms of this Contract, there are no third party beneficiaries to this Contract, and this Contract shall not impart any rights enforceable by any person or entity that is not a Party hereto.

XXXII. ENTIRE CONTRACT/WAIVER OF DEFAULT

The parties agree that this Contract is the complete understanding of the terms hereto and any oral or written representations or understandings not incorporated herein are excluded. Both parties recognize that time is of the essence in the performance of the provisions of this Contract. Waiver of any default shall not be deemed to be a waiver of any other or subsequent breach and shall not be construed to be a modification of the terms of the Contract unless stated to be such through written approval by the County, a copy of which shall be attached to the original copy of this Contract.

XXXIII. GOVERNING LAW/SEVERABILITY/CONSTRUCTION

This Contract shall be governed by Washington law. If any one or more provisions of this Contract shall be held by any court to be invalid or unenforceable, such invalidity or unenforceability shall not adversely affect the validity or enforceability of any other part of this Contract. This Contract shall not be construed for nor against any party, regardless of its drafter.

KING COUNTY



King County Executive

FOR

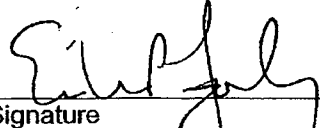

Signature

12/27/07

Date

Eileen F. Farley Executive Director

NAME (Please type or print)

12.18.07

Date

Approved as to Form:

OFFICE OF THE KING COUNTY
SPECIAL DEPUTY PROSECUTOR

Date: 11/29/07

EXHIBIT I

Certificate of Insurance/Endorsements

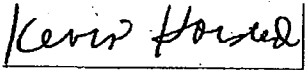
CERTIFICATE OF INSURANCE				ISSUE DATE: December 17, 2007
PRODUCER: NLADA Service Corporation 1140 Connecticut Avenue NW, 9 th Floor Washington, DC 20036		THIS CERTIFICATE IS ISSUED AS A MATTER OF INFORMATION ONLY AND CONFERS NO RIGHTS UPON THE CERTIFICATE HOLDER. THIS CERTIFICATE DOES NOT AMEND, EXTEND OR ALTER THE COVERAGE AFFORDED BY THE POLICIES BELOW		
INSURED: Northwest Defenders Association 1111 Third Ave., Suite 200 Seattle, WA 98101 FAX: (206) 674-4702 Attn: Terry Howard		COMPANY AFFORDING COVERAGE: Columbia Casualty Company		
THIS IS TO CERTIFY THAT THE POLICY OF INSURANCE LISTED BELOW HAS BEEN ISSUED TO THE INSURED NAMED ABOVE FOR THE POLICY PERIOD INDICATED. NOTWITHSTANDING ANY REQUIREMENT, TERM OR CONDITION OF ANY CONTRACT OR OTHER DOCUMENT WITH RESPECT TO WHICH THIS CERTIFICATE MAY BE ISSUED OR MAY PERTAIN. THE INSURANCE AFFORDED BY THE POLICY DESCRIBED HEREIN IS SUBJECT TO ALL THE TERMS EXCLUSIONS AND CONDITION OF SUCH POLICY. LIMITS SHOWN MAY HAVE BEEN REDUCED BY PAID CLAIMS.				
TYPE OF INSURANCE	POLICY NUMBER	POLICY EFFECTIVE DATE	POLICY EXPIRATION DATE	LIMITS
LAWYERS PROFESSIONAL LIABILITY	000800231	12:01 AM January 1, 2008	12:01 AM January 1, 2009	\$2,000,000 each claim and \$2,000,000 in the aggregate
SPECIAL ITEMS				
Certificate holder is included as additional insured.				
CERTIFICATE HOLDER:		CANCELLATION:		
King County Office of Public Defense 1123 Third Ave., 4 th Floor Seattle, WA 98104		SHOULD THE ABOVE DESCRIBED POLICY BE CANCELLED BEFORE THE EXPIRATION DATE THEREOF, THE ISSUING COMPANY WILL ENDEAVOR TO MAIL 10 DAYS WRITTEN NOTICE TO THE CERTIFICATE HOLDER NAMED TO THE LEFT, BUT FAILURE TO MAIL SUCH NOTICE SHALL IMPOSE NO OBLIGATION OR LIABILITY OF ANY KIND UPON THE COMPANY, ITS AGENTS OR REPRESENTATIVES.		
		AUTHORIZED REPRESENTATIVE:		
				

ACORD CERTIFICATE OF LIABILITY INSURANCE

OP ID RW
NOR5000

DATE (MM/DD/YYYY)
12/17/07

PRODUCER
Degginger McIntosh & Assoc.
PO Box 1400
3977 Harbour Pointe SW
Mukilteo WA 98275
Phone: 425-740-5200 Fax: 425-740-5201

INSURED

NW Defenders Association
1111 3rd Avenue
Seattle WA 98101-3292

THIS CERTIFICATE IS ISSUED AS A MATTER OF INFORMATION ONLY AND CONFERS NO RIGHTS UPON THE CERTIFICATE HOLDER. THIS CERTIFICATE DOES NOT AMEND, EXTEND OR ALTER THE COVERAGE AFFORDED BY THE POLICIES BELOW.

INSURERS AFFORDING COVERAGE		NAIC #
INSURER A:	West American Insurance Co.	44393
INSURER B:	The Ohio Casualty Ins. Co.	24074
INSURER C:		
INSURER D:		
INSURER E:		

COVERAGES

THE POLICIES OF INSURANCE LISTED BELOW HAVE BEEN ISSUED TO THE INSURED NAMED ABOVE FOR THE POLICY PERIOD INDICATED. NOTWITHSTANDING ANY REQUIREMENT, TERM OR CONDITION OF ANY CONTRACT OR OTHER DOCUMENT WITH RESPECT TO WHICH THIS CERTIFICATE MAY BE ISSUED OR MAY PERTAIN, THE INSURANCE AFFORDED BY THE POLICIES DESCRIBED HEREIN IS SUBJECT TO ALL THE TERMS, EXCLUSIONS AND CONDITIONS OF SUCH POLICIES. AGGREGATE LIMITS SHOWN MAY HAVE BEEN REDUCED BY PAID CLAIMS.

INSR ADD'L LTR	INSUR	TYPE OF INSURANCE	POLICY NUMBER	POLICY EFFECTIVE DATE (MM/DD/YY)	POLICY EXPIRATION DATE (MM/DD/YY)	LIMITS	
A	X	GENERAL LIABILITY	BZW53299850	01/01/08	01/01/09	EACH OCCURRENCE	
		<input checked="" type="checkbox"/> COMMERCIAL GENERAL LIABILITY				\$ 1,000,000	
		<input type="checkbox"/> CLAIMS MADE <input checked="" type="checkbox"/> OCCUR				DAMAGE TO RENTED PREMISES (Ea occurrence)	\$ 300,000
						MED EXP (Any one person)	\$ 10,000
						PERSONAL & ADV INJURY	\$ Excluded
						GENERAL AGGREGATE	\$ 2,000,000
		GEN'L AGGREGATE LIMIT APPLIES PER:				PRODUCTS - COM/OP AGG	\$ 2,000,000
		<input type="checkbox"/> POLICY <input checked="" type="checkbox"/> PRO-JECT <input type="checkbox"/> LOC					
A	A	AUTOMOBILE LIABILITY	BZW53299850	01/01/08	01/01/09	COMBINED SINGLE LIMIT (Ea accident)	
		<input type="checkbox"/> ANY AUTO				\$ 1,000,000	
		<input type="checkbox"/> ALL OWNED AUTOS				BODILY INJURY (Per person)	\$
		<input type="checkbox"/> SCHEDULED AUTOS				BODILY INJURY (Per accident)	\$
	<input checked="" type="checkbox"/> HIRED AUTOS	BZW53299850	01/01/08	01/01/09	PROPERTY DAMAGE (Per accident)	\$	
	<input checked="" type="checkbox"/> NON-OWNED AUTOS	BZW53299850	01/01/08	01/01/09			
		GARAGE LIABILITY				AUTO ONLY - EA ACCIDENT	\$
		<input type="checkbox"/> ANY AUTO				OTHER THAN AUTO ONLY: EA ACC	\$
						AGG	\$
B	X	EXCESS/UMBRELLA LIABILITY	UBO53299850	01/01/08	01/01/09	EACH OCCURRENCE	
		<input checked="" type="checkbox"/> OCCUR <input type="checkbox"/> CLAIMS MADE				\$ 2,000,000	
		<input type="checkbox"/> DEDUCTIBLE				AGGREGATE	\$ 2,000,000
	<input checked="" type="checkbox"/> RETENTION \$10,000						
		WORKERS COMPENSATION AND EMPLOYERS' LIABILITY				WC STATUTORY LIMITS	OTH-ER
		ANY PROPRIETOR/PARTNER/EXECUTIVE OFFICER/EMBER EXCLUDED?				E.L. EACH ACCIDENT	\$
		If yes, describe under SPECIAL PROVISIONS below				E.L. DISEASE - EA EMPLOYEE	\$
		OTHER				E.L. DISEASE - POLICY LIMIT	\$

DESCRIPTION OF OPERATIONS / LOCATIONS / VEHICLES / EXCLUSIONS ADDED BY ENDORSEMENT / SPECIAL PROVISIONS

Certificate Holder is included as Additional Insured per form BP0448 (0197) with respects to any & all operations of Named Insured.

CERTIFICATE HOLDER

CANCELLATION

KING008

King County, Office of the Public Defender
Walthew Bldg.
123 3rd Avenue S, Floor 4
Seattle WA 98104-2696

SHOULD ANY OF THE ABOVE DESCRIBED POLICIES BE CANCELLED BEFORE THE EXPIRATION DATE THEREOF, THE ISSUING INSURER WILL ENDEAVOR TO MAIL 30 DAYS WRITTEN NOTICE TO THE CERTIFICATE HOLDER NAMED TO THE LEFT, BUT FAILURE TO DO SO SHALL IMPOSE NO OBLIGATION OR LIABILITY OF ANY KIND UPON THE INSURER, ITS AGENTS OR REPRESENTATIVES.

AUTHORIZED REPRESENTATIVE
Kenneth McIntosh

ACORD 25 (2001/08)

© ACORD CORPORATION 1988

POLICY NUMBER

BUSINESSOWNERS
BP 04 48 01 97

THIS ENDORSEMENT CHANGES THE POLICY. PLEASE READ IT CAREFULLY.

**ADDITIONAL INSURED - DESIGNATED PERSON
OR ORGANIZATION**

This endorsement modifies insurance provided under the following:

BUSINESSOWNERS POLICY

SCHEDULE*

Name Of Person Or Organization:

KING COUNTY

* Information required to complete this Schedule, if not shown on this endorsement, will be shown in the Declarations.

The following is added to Paragraph C. Who Is An Insured in the Businessowners Liability Coverage Form:

4. Any person or organization shown in the Schedule is also an insured, but only with respect to liability arising out of your ongoing operations or premises owned by or rented to you.

12 of 24



King County

EXHIBIT II

Personnel Inventory Report

Legal name of business Northwest Defenders Association Contract No: D3788SD
 dba (if applicable) _____ Telephone No: _____
 Street address 1111 3rd Ave #200 City Seattle State WA Zip Code 98101
 Submitted by: Eileen Farley Title Executive Director Date 12/18/07

Do you have any employees? No ___ Yes Sole Owner/Operator No Yes ___

If yes, list on the Employment Data Chart below the total number of employees for all businesses located within each location listed below. Indicate which locale (1,2,3) report covers. This report is for Payroll Period ending (Month/Day/Year): 12/31/07 and covers the following locale: (Check only one box)

- 1. Business located within King County
- 2. ___ Businesses located within WA State
- 3. ___ Business located with U. S.
- 4. ___ Other (specify) _____

Do any of your employees belong to a union and/or do you use an employee referral agency? No ___ Yes

If yes, list the unions and/or employee referral agencies with whom you have agreements: Service Employees International Local 925, Utility Workers Assn Intemp you expect to do more than \$10,000 worth of public work (construction) or, more than \$25,000 worth of business with King County, the unions or employee referral agencies must submit a statement of compliance with King County Code Chapter 12.16.

Job Categories	Whites		African Americans		Asians		Native Americans		Hispanics		Disabled		Minority Subtotal		Disabled Subtotal	
	M	F	M	F	M	F	M	F	M	F	M	F	M	F	M	F
Managerial		1	1			1				1			1	2		
Professional	10	4	2	1	2	2			1				5	3		
Technical	5	4			1	2							1			
Clerical		1				1		1	1	2			2	3		
Sales																
Service																
Labor																
On-Job Trainees																
Apprentice																
Skilled Craft Total*																
Total													9	8		

Journey worker: List by classification on reverse, e.g., carpenter, plumber, etc.

Total number of employees reported above: 52 If no employees, write "0."



EXHIBIT III

Affidavit and Certificate of Compliance

with King County Code Chapter 12.16, Discrimination and Affirmative Action
in Employment by Contractors, Subcontractors and Vendors

The undersigned, being first duly sworn, on oath states, s/he is authorized by the Contractor, and on the Contractor's behalf, affirms and certifies as follows:

Definitions: "Contractor" shall mean any contractor, vendor or consultant who supplies goods and/or services. "Contract" shall mean any contract, purchase order or agreement with King County Government, hereinafter called the County.

- A. Contractor recognizes that discrimination in employment is prohibited by federal, state and local laws. Contractor recognizes that in addition to refraining from discrimination, affirmative action is required to provide equal employment opportunity. Contractor further recognizes that this Affidavit establishes minimum requirements for affirmative action and fair employment practices and implements the basic nondiscrimination provisions of the general contract specifications as applied to service, consultant, and vendor contracts exceeding \$25,000, or public work contracts exceeding \$10,000. Contractor herein agrees that this Affidavit is incorporated as an addendum to its general contract, and recognizes that failure to comply with these requirements may constitute grounds for application of sanctions as set forth in the general specifications, King County Code Chapter 12.16 ("Chapter") and this Affidavit. PROVIDED FURTHER, that in lieu of this Affidavit, the Executive may accept a statement pledging adherence to an existing contractor affirmative action plan where the provisions of the plan are found by the Executive to substantially fulfill the requirements of the Chapter.
- B. Contractor shall give notice to their supervisors and employees of the requirements for affirmative action to be undertaken prior to the commencement of work.
- C. This person has been designated to represent the Contractor and to be responsible for securing compliance with and for reporting on the affirmative actions taken:
- D. Contractor will cooperate fully with the BD and Contract Compliance Section and appropriate County agents while making every reasonable "good faith" effort to comply with the affirmative action and nondiscrimination requirements set forth in this Affidavit and in King County Code Chapter 12.16.
- E. Reports: The Contractor agrees to complete and submit as required such additional reports and records that may be necessary to determine compliance with the Affidavit and to confer with the County Compliance Officer at such times as the County shall deem necessary. The information required by the Chapter includes but is not limited to the following reports and records:
 - 1. **Personnel Inventory Report:** This report shall include a breakdown of the employer workforce showing race, sex and handicapped and other minority data.
 - 2. **Monthly EEO Report:** This report shall apply to construction contractors and subcontractors and shall provide the number of hours of employment for all employees, including minority, women and disabled employees by craft and category.
 - 3. **Statement from Union or Worker Referral Agency:** This statement affirms that the contractor's organization has no practices and policies which discriminate on the basis of race,

color, creed, religion, sex, age, marital status, sexual orientation, nationality or the presence of sensory, mental or physical disability.

The information required in this section shall be submitted on forms provided by the County unless otherwise specified.

- F. **Subcontractors:** For public works projects and contracts over ten thousand dollars (\$10,000) the prime contractor shall be required to submit to the County, along with its qualifying documents under the Chapter, employment profiles, Affidavits and Certificates of Compliance, Reports and Union Statements from its subcontractors in the same manner as these are required of the prime contractor. Reporting requirements of the prime contractor during the contract period will apply equally to all subcontractors.
- G. **Employment Goals for Minorities, Women and Persons with Disabilities:** No specific levels of utilization of minorities and women in the workforce of the Contractor shall be required, and the Contractor is not required to grant any preferential treatment on the basis of race, sex, color, ethnicity or national origin in its employment practices. Notwithstanding the foregoing, any affirmative action requirements set forth in any federal regulations, statutes or rules included or referenced in the contract documents shall continue to apply.
- H. **Affirmative Action Measures:** Contractor agrees to implement and/or maintain reasonable good faith efforts to comply with King County Code Chapter 12.16. The evaluation of a contractor's compliance with the Chapter shall be based upon the contractor's effort to achieve maximum results from its affirmative action measures. The Contractor shall document these efforts and shall implement affirmative action steps at least as extensive as the following:
 - 1. **Policy Dissemination:** Internal and external dissemination of the contractor's equal employment opportunity policy; posting of nondiscrimination policies and of the requirement of the Chapter on bulletin boards clearly visible to all employees; notification to each subcontractor, labor union or representative of workers with which there is a collective bargaining agreement or other contract, subcontract, or understanding of the contractor's commitments under the Chapter. Inclusion of the equal opportunity policy in advertising in the news media and elsewhere.
 - 2. **Recruiting:** Adopt and implement recruitment procedures designed to increase the representation of women, minorities and persons with disabilities in the pool of applicants for employment: including, but not limited to establishing and maintaining a current list of minority, women and disabled recruitment sources, providing these sources written notification of employment opportunities and advertising vacant positions in newspapers and periodicals which have minority, women and/or disabled readership.
 - 3. **Self-Assessment and Test Validation:** Review of all employment policies and procedures, including tests, recruitment, hiring and training practices and policies, performance evaluations, seniority policies and practices, job classifications and job assignments to assure that they do not discriminate against, or have a discriminatory impact on, minorities, women and persons with disabilities and validate all tests and

other selection requirements where there is an obligation to do so under state or federal law.

- 4. **Record Referrals:** Maintain a current file of applications of each minority, women and persons with disabilities who are applicants or referrals for employment indicating what action was taken with respect to each such individual and the reasons therefor. Contact these people when an opening exists for which they may be qualified. Names may be removed from the file after twelve months have elapsed from their last application or referral.
- 5. **Notice to Unions:** Provide notice to labor unions of the contractor's nondiscrimination and affirmative action obligations pursuant to King County Code Chapter 12.16. Contractors shall also notify the BD and Contract Compliance Section if labor unions fail to comply with the nondiscrimination or affirmative provisions
- 6. **Supervisors:** Ensure that all supervisory personnel understand and are directed to adhere to and implement the non-discrimination and affirmative action obligations of the contractor under King County Code Chapter 12.16. Such direction shall include, but not be limited to, adherence to, and achievement of, affirmative action policies in performance appraisals of supervisory personnel.
- 7. **Employee Training:** When reasonable, develop on-the-job training opportunities which expressly include minorities, women, and persons with disabilities and sponsor and/or utilize, training/educational opportunities for the advancement of women, minorities and persons with disabilities employed by the contractor, subject to acceptance by the county.
- 8. **Responsible Person:** Designate an employee who shall have the responsibility for implementation of the Contractor's affirmative action measures.
- 9. **Progress Reporting:** Prepare as part of the affirmative action plan an analysis and report on the progress made toward eliminating the underrepresentation of minorities, women, and persons with disabilities in the contractor's workforce on

an annual basis.

- I. During the performance of this Contract, neither the Contractor nor any party subcontracting under the authority of this Contract shall discriminate nor tolerate harassment on the basis of race, color, sex, religion, nationality, creed, marital status, sexual orientation, age, or the presence of any sensory, mental or physical disability in the employment or application for employment or in the administration or delivery of services or any other benefits under this Contract.
- J. Contractor agrees to provide reasonable access upon request to the premises of all places of business and employment, relative to work undertaken in this Contract, and to records, files, information and employees in connection therewith, to the BD and Contract Compliance Section or agent for purposes of reviewing compliance with the provisions of this Affidavit and agrees to cooperate in any compliance review.
- K. Should the BD and Contract Compliance Section find, upon complaint investigation or review, the Contractor not to be in good faith compliance with the provisions contained in this Affidavit, it shall notify the County and Contractor in writing of the finding fully describing the basis of non-compliance. Contractor may request withdrawal of such notice of noncompliance at such time as the compliance office has notified in writing the Contractor and the County that the noncompliance has been resolved.
- L. The Contractor agrees that any violation of any term of this Affidavit, including reporting requirements, shall be deemed a violation of King County Code Chapter 12.16. Any such violation shall be further deemed a breach of a material provision of the Contract between the County and the Contractor. Such breach may be grounds for implementation of any sanctions provided for in the Chapter, including but not limited to, cancellation, termination or suspension, in whole or part, of the Contractor by the County; liquidated damages; or disqualification of the Contractor PROVIDED, that the implementation of any sanctions is subject to the notice and hearing provisions of King County Code Chapter 12.16.110.

Contractor: Northwest Defenders Association 1111 3rd Avenue #200 Seattle, WA 98101
Company Name Street Address City State Zip

I have read and understood the foregoing; and am authorized on behalf of the Contractor to agree to the terms and conditions of this and Affidavit and Certificate of Compliance and therefore, execute the same.

Authorized Signer: Eileen P. Farley Executive Director 206-674-4700 E. Farley
Name (type or print) Title Phone Signature

VALID ONLY IF NOTARIZED

SUBSCRIBED AND SWORN TO BEFORE ME THIS 18th DAY OF December, 2007.

Terry K. Howard
 Notary Public in and of the state of Washington

Residing at: Snohomish



EXHIBIT IV

504/ADA SELF-EVALUATION AND ASSURANCE OF COMPLIANCE

Instructions

504/ADA Self-Evaluation Questionnaire Form

This form will help you evaluate your organization's or firm's programs and services, employment, and facilities to ensure they are accessible to people with disabilities. Complete the 504/ADA Self-Evaluation Questionnaire and keep it on file at your office. Do not return the questionnaire with your contract.

"Quick Look" Barriers Checklist

Note: If the business is a construction company, this form pertains only to the main office, not the construction sites. Firms that provide services outside their office do not need to write a corrective action plan for physical accessibility as long as these services are provided in an accessible location for people with disabilities who cannot access the office. However, physical access must also be reviewed in light of hiring an individual with a disability or accommodating a current employee who becomes disabled.

504/ADA Assurance of Compliance Form

All contractors must complete this form, as required by King County Code 12.16.060. Governmental agencies and contracts for the direct purchase of goods are exempt.

- **Complete this form.** If your organization or firm is out of compliance with any of the 504/ADA requirements, indicate on the 504/ADA Disability Assurance of Compliance form the corrective actions that will be taken to achieve compliance and the date these actions will be completed.
- **Sign the Assurance of Compliance form and send the original back with your contract.** Keep a copy of the form on file in your office for use during on-site reviews. You will be notified at least one week in advance of any scheduled review. (Note: This form may be used as an exhibit with other King County contracts for two years from the date the form is completed.)

If you have questions regarding this process, or if you require this material in an alternate format, please contact a King County 504/ADA Disability Compliance Specialist at 206-296-7592 or 206-296-7596 TTY, or by e-mail: Civil-Rights.OCR@kingcounty.gov.

504/ADA General Information

Federal and State laws prohibit discrimination based on disability. Section 504 of the Rehabilitation Act of 1973, as amended (504), and the Americans with Disabilities Act of 1990 (ADA) require that King County and all organizations and firms contracting with King County, except those providing tangible goods, comply with the 504/ADA accessibility requirements.

Under 504 and ADA, a "qualified individual with a disability" is anyone who has, has a history of, or is perceived as having a physical or mental impairment which substantially limits one or more major life activities. Disabilities include, but are not limited to: mobility, visual, hearing, or speech disabilities; mental illness; epilepsy; learning disability; brain injury; HIV/AIDS; arthritis; cerebral palsy; multiple sclerosis; developmental disability; and alcohol and/or drug addiction.

DISABILITY RESOURCE LIST

Note: Inclusion in this resource list does not constitute endorsement by King County Government, nor does omission imply non-endorsement. Our goal is to provide you with information on some key resources available. Please contact us if you know of a useful resource missing from this list.

**King County Office of Civil Rights
Disability Compliance Specialist, Yesler
Building, 400 Yesler Way, Room 260, Seattle,
WA 98104-2683; 206-296-7592 V,
206-296-7596 TTY; 206-296-4329 Fax;
e-mail: Civil-Rights.OCR@kingcounty.gov
web site: www.metrokc.gov/dias/ocre**

**Governor's Committee on Disability Issues
and Employment (GCDE)**
Advises and informs the Governor, state and
local governments, the business community,
and the disability community on ADA and other
issues related to disability policy.
Olympia: 360-438-3168 V, 360-438-3167 TTY;
Spokane: 509-532-3149 V, 509-532-3113 TTY.

**GCDE publishes "Producing Materials in
Alternative Formats: A Guide for Agencies"**
which provides information on producing
materials in large print, on audio tape or
computer disk, and Braille. Send a written
request for a copy.

DBTAC Northwest
Provides information on the Americans with
Disabilities Act in Alaska, Idaho, Oregon and
Washington. Western Washington University
6912 220th St. SW, Suite 105
Mountlake Terrace, WA 98043
800-949-4232 V/TTY
425-774-9303 Fax
e-mail: dbtacnw@wwu.edu
web site: www.dbtacnorthwest.org

**Sprint Washington Telecommunications
Relay Service (TRS)**
Provides free telephone accessibility with TTY
users. 500 108th Avenue NE, Suite 800,
Bellevue, WA 98004; Relay Services: 711 TTY;
800-833-6384 V.

**ADA Technical Assistance Hotline
(U.S. Dept. of Justice)**
Provides free technical assistance and
informational materials to people with
disabilities, businesses, state and local
government agencies, and the general public on
rights and responsibilities under Titles II and III
of the ADA. 800-514-0301 V/TTY.
web site: www.usdoj.gov/crt/ada

**Washington Assistive Technology Alliance
(WATA)**
Information & referral to disability resources,
including assistive technology options, funding
sources, legal issues, accommodations.
509-328-9350 V/TTY; 800-214-8731 V/TTY;
509-326-2261 Fax; e-mail: spokane@seals.org
web site: wata.org/wata/eatrc/index.htm

Job Accommodations Network (JAN)
An international toll-free consulting service that
provides information regarding the ADA, job
accommodations and the employability of
people with disabilities. P.O. Box 6080,
918 Chestnut Ridge Road, Suite 1, Morgantown,
WV 26506-6080;
JAN ADA Information 800-526-7234 V/TTY;
800-ADA-WORK (232-9675) V/TTY;
web site: janweb.icdi.wvu.edu

**Emergency Procedures for Employees with
Disabilities in Office Occupancies**
A procedural guideline funded by the U.S. Fire
Administration and developed by the National
Institute of Standards and Technology with
assistance from the National Task Force on Life
Safety and People with Disabilities. Write for a
copy of Item Number FA -154: United States
Fire Administration, 16825 South Seton Avenue,
Emmitsburg, MD 21727.

504/ADA SELF-EVALUATION QUESTIONNAIRE

General Requirements

Please check the appropriate answers. If necessary, attach additional pages of explanation. If you have fewer than 15 employees, please skip the first section and start with "Program Access."

- | | YES | NO | N/A |
|---|--------------------------------------|--------------------------|--------------------------|
| 1. Do you have a 504/ADA coordinator? If so, who? | <input type="checkbox"/> | <input type="checkbox"/> | <input type="checkbox"/> |
| Name | <u>Steve Terry Howard</u> | | |
| Title | <u>Office Administrator/HR</u> | | |
| Phone | <u>206-674-4700 ext. 3102</u> | | |
| 2. Do you have an internal grievance procedure that allows for quick and prompt solutions for any complaints based on alleged noncompliance with 504/ADA? | <input checked="" type="checkbox"/> | <input type="checkbox"/> | <input type="checkbox"/> |
| 3. Do you have a policy that provides for notifying participants, applicants, employees, unions, and professional organizations holding collective bargaining or professional agreements that you do not discriminate on the basis of disability? | <input checked="" type="checkbox"/> | <input type="checkbox"/> | <input type="checkbox"/> |
| 4. Have you notified these individuals of your nondiscrimination policy? | <input checked="" type="checkbox"/> | <input type="checkbox"/> | <input type="checkbox"/> |
| 5. Do you provide ongoing staff training to ensure that staff fully understand your policy of nondiscrimination on the basis of disability and can take all appropriate steps to facilitate the participation of individuals with disabilities in agency programs and activities? | <input checked="" type="checkbox"/> | <input type="checkbox"/> | <input type="checkbox"/> |

Program Access

- | | | | |
|---|--------------------------|--------------------------|-------------------------------------|
| 1. Do you notify the public and other interested parties that agency meetings, board of director meetings, hearings, conferences, public appearances by elected officials, and interviews will be held in accessible locations? | <input type="checkbox"/> | <input type="checkbox"/> | <input checked="" type="checkbox"/> |
| 2. Do you notify the public and other interested parties that auxiliary aids (sign language interpreters, readers) will be provided, upon request, to participants with disabilities? | <input type="checkbox"/> | <input type="checkbox"/> | <input checked="" type="checkbox"/> |
| 3. Do you have a Teletypewriter (TTY), or do you use the statewide Telecommunications Relay Service to facilitate communication with individuals who use TTYs for communication purposes? | <input type="checkbox"/> | <input type="checkbox"/> | <input checked="" type="checkbox"/> |
| 4. Do you provide ongoing training to familiarize appropriate staff with the operation of the TTY (or Relay Service) and other effective means of communicating over the telephone with people with disabilities? | <input type="checkbox"/> | <input type="checkbox"/> | <input checked="" type="checkbox"/> |

Program Access (continued)

- | | YES | NO | N/A |
|--|-------------------------------------|-------------------------------------|-------------------------------------|
| 5. Do you make available, upon request, written material in alternate formats for people who have disabilities? (Alternate formats include large print, Braille, and audiocassette tapes) | <input type="checkbox"/> | <input checked="" type="checkbox"/> | <input type="checkbox"/> |
| 6. Are printed posters, announcements, and printed materials (including graphics) clearly legible and placed in physically accessible locations where print can be read from a wheelchair? | <input checked="" type="checkbox"/> | <input type="checkbox"/> | <input type="checkbox"/> |
| 7. If you have a mailing list for the purposes of information dissemination, does it include various disability groups? | <input type="checkbox"/> | <input type="checkbox"/> | <input checked="" type="checkbox"/> |
| 8. Are your TTY number and procedures for accessing your services printed on all material distributed to the public? | <input type="checkbox"/> | <input type="checkbox"/> | <input checked="" type="checkbox"/> |
| 9. Do you have a policy and procedure for safe emergency evacuation of people with disabilities from your facility(s)? | <input checked="" type="checkbox"/> | <input type="checkbox"/> | <input type="checkbox"/> |

Employment and Reasonable Accommodation

- | | | | |
|---|-------------------------------------|-------------------------------------|-------------------------------------|
| 1. When gathering affirmative action data regarding disabilities, do you make it clear that: <ul style="list-style-type: none"> • the information requested is intended for use solely in connection with reporting requirements; • the information is voluntary; • the information will be kept confidential; and • refusal to provide or providing the information will not subject the applicant or employee to any adverse treatment? | <input type="checkbox"/> | <input type="checkbox"/> | <input checked="" type="checkbox"/> |
| 2. If you make pre-employment medical inquiries or conduct pre-employment medical examinations: | | | |
| • Is the inquiry related to the applicant's ability to perform the job? | <input type="checkbox"/> | <input checked="" type="checkbox"/> | <input type="checkbox"/> |
| • Do you condition offers of employment on the results of these examinations? | <input type="checkbox"/> | <input checked="" type="checkbox"/> | <input type="checkbox"/> |
| • Is the examination required for <u>all</u> employees in the same job classification? | <input type="checkbox"/> | <input type="checkbox"/> | <input checked="" type="checkbox"/> |
| • Are <u>all</u> applicants in the same job classification asked the same medical and/or interview questions? | <input checked="" type="checkbox"/> | <input type="checkbox"/> | <input type="checkbox"/> |
| 3. During the application, interviewing, hiring, and employment process, do you provide reasonable accommodations to applicants and employees with disabilities? | <input checked="" type="checkbox"/> | <input type="checkbox"/> | <input type="checkbox"/> |

Employment and Reasonable Accommodation (continued)

YES NO N/A

4. Do you have a written policy stating the following?

504/ADA requires that information concerning an applicant's medical condition or history must be kept separate from personnel records and may be shared in only three ways:

- (1) supervisors and managers may be informed of restrictions on the work or duties of individuals with disabilities and informed of necessary accommodation(s);
- (2) first aid and safety personnel may be informed if the condition might require emergency treatment; and
- (3) government officials investigating compliance with 504/ADA shall be provided with relevant information upon request.

Physical Accessibility

Complete the "Quick Look" Barriers Checklist and then answer the following questions:

1. Is the building(s) where your business is located barrier-free?

2. If you checked NO to any of the items on the Employment and Reasonable Accommodation checklist above, would these areas prevent an individual with a disability from accessing your program(s) or service(s)?

If access would be impacted, describe on the Corrective Action Plan what steps will be taken to eliminate the barrier(s). If there are extenuating circumstances which would make barrier removal a financial or administrative burden, please explain in the Corrective Action Plan.

This 504/ADA Self-Evaluation Questionnaire was completed by:

Eileen Farley Executive Director 200-674-4700
Print name Date Phone Number 212-3100

"QUICK LOOK" BARRIERS CHECKLIST

This checklist may be used to conduct a quick appraisal of potential problem areas for accessibility. For detailed review standards, refer to IBC 2003, ANSI A117.1-2003, and the Washington State Administrative Code (WAC) 51-50. If you are not located in State of Washington, you may refer to federal ADA Accessibility Guidelines (ADAAG), state or local laws and regulations.

Building Access

	YES	NO	N/A
• Garage/lot has required number of accessible parking spaces?	<input checked="" type="checkbox"/>	<input type="checkbox"/>	<input type="checkbox"/>
• Are accessible parking spaces near main building entrance? <i>parking garage</i>	<input checked="" type="checkbox"/>	<input type="checkbox"/>	<input type="checkbox"/>
• Walkways are level (44" wide min.) or ramped (max. 1:12)? <i>short in</i>	<input checked="" type="checkbox"/>	<input type="checkbox"/>	<input type="checkbox"/>
• Does the entrance doorway have at least 32" wide clearance?	<input checked="" type="checkbox"/>	<input type="checkbox"/>	<input type="checkbox"/>
• Is the door threshold maximum 1/4" high (1/2" if beveled)?	<input checked="" type="checkbox"/>	<input type="checkbox"/>	<input type="checkbox"/>
• Door hardware is lever handles, pulls, or push-pull activating bars?	<input checked="" type="checkbox"/>	<input type="checkbox"/>	<input type="checkbox"/>
• Are the doors easy to open (exterior doors max. 8.5 lbs. opening force, interior doors 5 lbs. max.)?	<input checked="" type="checkbox"/>	<input type="checkbox"/>	<input type="checkbox"/>
• If revolving doors used, alternate accessible entrance available?	<input checked="" type="checkbox"/>	<input type="checkbox"/>	<input type="checkbox"/>

Building Corridors

• Is path of travel free of obstruction and at least 36" wide?	<input checked="" type="checkbox"/>	<input type="checkbox"/>	<input type="checkbox"/>
• Is floor surface stable, firm and slip resistant?	<input checked="" type="checkbox"/>	<input type="checkbox"/>	<input type="checkbox"/>
• Do obstacles (phones, fountains, etc.) protrude no more than 4"?	<input checked="" type="checkbox"/>	<input type="checkbox"/>	<input type="checkbox"/>
• If provided, minimum one public phone or water fountain accessible?	<input checked="" type="checkbox"/>	<input type="checkbox"/>	<input type="checkbox"/>
• Are elevator controls no higher than 48"?	<input checked="" type="checkbox"/>	<input type="checkbox"/>	<input type="checkbox"/>
• Are elevator markings in Braille and raised letters/numbers?	<input checked="" type="checkbox"/>	<input type="checkbox"/>	<input type="checkbox"/>
• Does elevator provide audible and visible signals?	<input checked="" type="checkbox"/>	<input type="checkbox"/>	<input type="checkbox"/>
• Floor of elevator cab is min. 51" x 68" (door offset) or 51" x 80" (door centered)?	<input checked="" type="checkbox"/>	<input type="checkbox"/>	<input type="checkbox"/>

Restrooms

• Door hardware is lever handles, pulls, or push-pull activating bars?	<input checked="" type="checkbox"/>	<input type="checkbox"/>	<input type="checkbox"/>
• Do restroom entrance doors have at least 32" wide clearance?	<input checked="" type="checkbox"/>	<input type="checkbox"/>	<input type="checkbox"/>
• Is restroom large enough for wheelchair turnaround (5' diameter)?	<input checked="" type="checkbox"/>	<input type="checkbox"/>	<input type="checkbox"/>
• Does accessible stall door have at least 32" wide clearance?	<input checked="" type="checkbox"/>	<input type="checkbox"/>	<input type="checkbox"/>
• Are grab bars provided in accessible toilet stalls?	<input checked="" type="checkbox"/>	<input type="checkbox"/>	<input type="checkbox"/>
• Toilet seat top is 17-19" above floor?	<input checked="" type="checkbox"/>	<input type="checkbox"/>	<input type="checkbox"/>
• Sink has clear knee space under basin; exposed pipes are insulated?	<input checked="" type="checkbox"/>	<input type="checkbox"/>	<input type="checkbox"/>
• Faucets are lever-operated or push-type?	<input checked="" type="checkbox"/>	<input type="checkbox"/>	<input type="checkbox"/>
• Are soap and towel dispensers no more than 40" from the floor?	<input checked="" type="checkbox"/>	<input type="checkbox"/>	<input type="checkbox"/>

Reception and Personnel Office

• Lower counter space in reception, customer service areas?	<input type="checkbox"/>	<input type="checkbox"/>	<input type="checkbox"/>
• Do doors have at least 32" wide clearance?	<input checked="" type="checkbox"/>	<input type="checkbox"/>	<input type="checkbox"/>
• Is the door easy to open (max. 5 lbs. opening force)?	<input type="checkbox"/>	<input type="checkbox"/>	<input type="checkbox"/>
• Door threshold is maximum 1/4" high (1/2" if beveled)?	<input checked="" type="checkbox"/>	<input type="checkbox"/>	<input type="checkbox"/>
• Is the path of travel between furniture at least 36"?	<input checked="" type="checkbox"/>	<input type="checkbox"/>	<input type="checkbox"/>

assistance available in reception

Required Number of Accessible Parking Spaces

Total Garage/Lot Parking Spaces	Minimum No. of Accessible Spaces
1-25	1 (van accessible)
26-50	2 (including one van space)
51-75	3 (including one van space)
76-100	4 (including one van space)
101-150	5 (including one van space)
151-200	6 (including one van space)
201-300	7 (including two van spaces)
301-400	8 (including two van spaces)
401-500	9 (including two van spaces)
501-1000	2% of total spaces (every six accessible spaces include one van space)
More than 1000	20, plus 1 for each 100 over 1000 (every six accessible spaces include one van space)

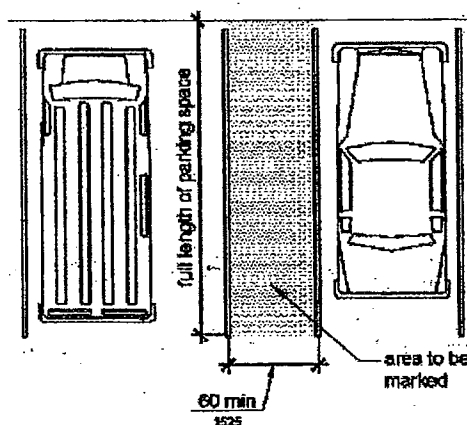

Locate accessible parking spaces on the shortest accessible route of travel to an accessible building entrance (where practical, not crossing traffic lanes).

Car and van parking spaces shall have an adjacent access aisle. Two parking spaces may share an access aisle. Van parking spaces that are angled shall have access aisles located on the passenger side of the parking space.

If there is only one accessible parking space, then it shall meet the codes for a van accessible parking space: 11' wide vehicle parking space plus a 5' access aisle. (An 8' vehicle parking space with an 8' access aisle is acceptable under code.)

For more detail, consult Washington State Building Code (WAC 51-50).

504/ADA DISABILITY ASSURANCE OF COMPLIANCE

Complying with Section 504 of the Rehabilitation Act of 1973, as amended, and the Americans With Disabilities Act of 1990, two federal laws which prohibit discrimination against qualified people with disabilities.

I understand that federal and state laws prohibit discrimination in public accommodations and employment based solely on disability. In addition, I recognize that Section 504 requires recipients of federal funds (either directly or through contracting with a governmental entity receiving federal funds) to make their programs, services, and activities, when viewed in their entirety, accessible to qualified and/or eligible people with disabilities. I agree to comply with, and to require that all subcontractors comply with, the Section 504/ADA requirements. I understand that reasonable accommodation is required in both program services and employment, except where to do so would cause an undue hardship or burden.

I agree to cooperate in any compliance review and to provide reasonable access to the premises of all places of business and employment and to records, files, information, and employees therein to King County for reviewing compliance with Section 504 and ADA requirements.

I agree that any violation of the specific provisions and terms of the 504/ADA Disability Assurance of Compliance and/or Corrective Action Plan required herein or Section 504 or the ADA, shall be deemed a breach of a material provision of the Contract between the County and the Contractor. Such a breach shall be grounds for cancellation, termination, or suspension, in whole or in part, of this Contract by the County.

According to the responses to the questions in the 504/ADA Self-Evaluation Questionnaire, Contractor is in compliance with 504/ADA. If the response is NO, the actions outlined in the below Corrective Action Plan will be taken.

YES NO

Contractor: Northwest Defenders Association
Company Name
111 3rd Avenue # 200 Seattle WA 98105
Street Address City State Zip

Corrective Action Plan

The following Corrective Action Plan is submitted to comply with Section 504 and ADA requirements.

General Requirements

Actions To Be Taken	Completion Date

504/ADA DISABILITY ASSURANCE OF COMPLIANCE (continued)

Program Access

Actions To Be Taken	Program Access	Completion Date

Employment and Reasonable Accommodation

Actions To Be Taken	Employment and Reasonable Accommodation	Completion Date

Physical Accessibility

Actions To Be Taken	Physical Accessibility	Completion Date

Declare Under Penalty of Perjury under the Laws of the State of Washington that the Foregoing is True and Correct.

Signature of authorized signator

Type or print name of authorized signator Title Telephone

For Notary:

State of _____, County of _____

Signed and sworn before me on (date) _____ by (print authorized signator name) _____

Notary signature: _____

Notary (print name): _____

My appointment expires: _____

Note: This form may be used as an exhibit with other King County contracts for two years from the date the form is completed.

EXHIBIT V

PUBLIC DEFENSE LEGAL SERVICES

I. WORK STATEMENT

The Agency shall provide the services of attorneys and staff members in compliance with all of the applicable laws and administrative regulations of the State of Washington, the United States, King County Code (KCC), Washington State Rules for Professional Conduct (RPC).

II. PROGRAM DESCRIPTION

A. Goal

To provide legal services through effective assistance of counsel to indigent persons, that is statutorily and constitutionally based, within the framework of an efficient and fiscally responsible independent non-profit Agency.

B. Eligible Population

The population served shall be indigent persons legally entitled to appointed legal services in King County courts as assigned by the Office of The Public Defender (OPD) or as appointed from the bench.

C. Definitions

1. Case Categories:

a. Becca: CHINS/ARY/Truancy practice area:

- i. CHINS/ARY Petition: A Child in Need of Services (CHINS) petition and At Risk Youth (ARY) petition involves the representation of one child or one parent from the filing of the petition through conclusion of services related to the petition. This includes representation on the initial petition, as well as any subsequent review hearings. In the event that a court consolidates a truancy matter with proceedings under a Youth at Risk or Child in Need of Services Petition, the Agency shall receive credit for the truancy representation.
- ii. Truancy: A petition filed under Revised Code of Washington (RCW) 28A.225.030. A case assignment will be made when the Court notifies OPD of a signed judicial order, setting a show cause hearing for Contempt of Court and requiring appointment of counsel.

b. Calendars: The Agency shall provide coverage for calendars if indicated in Attachment B, Calendar Attorney and Staff List. The calendars are defined as follows:

- i. **Dependency Calendar:** All initial 72-hour shelter care calendars in Seattle or Regional Justice Center (RJC) shall include the presence of an attorney.
- ii. **General Attorney of the Day (AOD):** The Agency will in good faith attempt to provide legal advice 24 hours a day seven days a week via beeper access and respond promptly to any accused adult or juvenile who is in the investigation phase or recently charged with a crime or detained on a civil matter within the jurisdiction of OPD. AOD for legal advice may occur both in RJC and Seattle. AOD includes a request from a defendant for substantial legal advice or a police agency to respond for line-up presentations. A call to the 24 hour beeper is calendar work not a case assignment.

Where substantial advice services are provided as a result of initial General AOD contact via beeper, credits can be requested as per Attachment A. "Substantial advice" includes legal services beyond providing of simple direct, one-time legal advice by phone or in person at a detention facility, and includes ongoing legal services preliminary to a formal appointment as counsel for prospective client.

Individual substantial advice assignments may also be appointed by the court or assigned by OPD, where the scope of work exceeds that described in the General AOD paragraph above.

- iii. **Felony Arraignment Calendar.**
- iv. **Felony Sentence Modification Calendar:** The Superior Court Probation Modification Calendar.
- v. **Juvenile AOD:** The Agency shall provide Juvenile Special Services which include making "morning rounds" in juvenile detention; lineups, detention reviews and arraignments; diversion counseling per RCW 13.40.080; and representing offenders as counsel until an attorney is formally appointed.
- vi. **Juvenile First Appearance Calendar:** Each Agency representing juveniles shall provide representation on the Juvenile First Appearance Calendar. Representation of juveniles on this daily Juvenile Court Calendar shall include prior clients and/or unrepresented juveniles. Time spent on this calendar shall include preparatory work done concerning the juveniles listed on the calendar who do not appear because of expedited filing by the Prosecuting Attorney, release from detention prior to hearing, or other reasons for non-appearance.
- vii. **King County Court Misdemeanor calendars include:** District Court Felony Investigation Calendar, Bench Warrant Return Calendar, and initial detention hearings for new misdemeanor charges.

- c. **Civil Contempt of Court practice area:** A civil contempt case shall include legal representation up to a maximum of three hearings, related solely to a contempt citation and shall be limited to cases where the factual likelihood of loss of liberty arises from an act of King County or the State of Washington or a judicial act.
- d. **Dependency practice area:** Coverage for all dependency, termination, guardianship, dependency guardianship, contested private adoption termination, and Reinstatement of Parental Rights cases.
 - i. **Dependency Case:** A dependency case credit is given for the legal representation of a client from:
 - 1) The initial predispositional assignment through the dispositional hearing. Should an agreed order of dependency be entered on or before the date of the 30-day shelter care review, it shall be considered part of the dependency case. If the case is assigned to the Agency after the establishment of dependency and entry of the dispositional order, an initial case credit shall be given at the time of assignment; and
 - 2) The filing of a termination or guardianship petition to the setting of a termination or guardianship trial date. Should an agreed order of termination or guardianship be entered on or before the preliminary hearing, it shall be considered part of the termination or guardianship case.
 - 3) Appointment of counsel pursuant to RCW 26.33.110 for contested private adoption termination shall be considered a termination of parental rights appointment for credit purposes. The Agency shall not be required to have more than two open RCW 26.33.110 cases at a given time.
 - ii. **Post-Dispositional Hearing:** A dependency review shall include legal representation at any post-dispositional hearing or hearings related to the original dependency filing, excluding the initial 72 hour shelter care review, the 30-day shelter care review, and the dispositional hearing. Reviews included within this category shall include, but not be limited to: the initial progress review, six month review hearings, permanency planning hearings, new shelter hearings occurring post disposition, or other reviews or hearings set by the parties or by the court. If a review hearing is continued, additional credit shall not be allocated for the review unless the substantive issues within the review hearing change or substantial work is done. In the event that a court consolidates a family court matter with proceedings under a dependency case, pursuant to Local Juvenile Court Rules (LJuCR) 3.13, the Agency shall receive additional dependency review credit under this section for representation involving hearings in the consolidated matter.

iii. **Dependency Trial/Termination or Guardianship Trial**

1) A dependency trial shall include:

- a) A fact finding for a dependency and the preparation for said fact finding or the entry of an agreed order of dependency and agreed dispositional order at the time of the scheduled dependency fact finding; or
- b) Entry of an agreed order of dependency and any contested hearing or hearings related to the dispositional order pursuant to the agreed order, as described in RCW 13.34.110 (1) and (2). This does not include post-dispositional review hearings.

2) A termination trial shall include:

- a) A fact-finding on a termination petition or guardianship petition and the preparation for said fact finding; or
- b) Entry of an agreed order regarding termination or guardianship petition at the time of the scheduled fact-finding.

iv. If more than one petition is pending involving one client, only one case shall be allowed credit. If matters involving one client with multiple petitions are severed for separate proceedings on different petitions, credit shall be given for such hearings. In the event that a new petition is filed as to a parent involving a child not previously involved in prior proceedings and that petition is filed post-disposition of previously filed petitions, then a new case credit will be allowed on the newly filed petition.

v. **Reinstatement of Parental Rights Matters:** Representation of a client from the time of appointment of counsel through completion of the matter to point of either completed reinstatement of parental rights, or dismissal of the Petition for Reinstatement of Parental Rights. To the extent that any hearings held in this matter are also concurrently a permanency plan hearing or review hearing in the related dependency matter, no additional review credits are given for those hearings for purpose of the related dependency matter.

e. **Felony practice area:**

i. **Felony Case:** All legal representation related to a case filed in the Criminal Division of King County Superior Court by the King County Prosecutor's Office, alleging a violation of criminal law and having a maximum sentence of more than one year, through sentencing and any restitution hearing and as listed in Attachment A.

- ii. **Felony/Probation Review:** A felony/probation review shall include legal representation at any hearing or hearings arising from a single notice of hearing subsequent to disposition of the case. Areas within this category shall include, but not be limited to: probation reviews, revocations, early release, conditional release, safe-to-be-at-large, temporary release, medical release, and material witness hearings. A restitution hearing will be a review only if it is assigned to an agency other than the agency which represented the client at sentencing.
- iii. **Persistent Offender (I 593 C 1 L 94; RCW 9.94A.030(33); RCW 9.94A.570):** Persistent offender is a defendant as defined by RCW 9.94A.030(33) and subject to sentencing pursuant to RCW 9.94A.570. The Agency shall provide documentation to OPD to verify a persistent offender case status.
- iv. **Complex Litigation:** All death penalty homicide cases and all aggravated homicide cases. Aggravated homicide cases are considered death penalty cases until such time as decision is made by the Prosecuting Attorney not to file a notice of intention to seek death.
 - 1) Complex litigation cases are "pending" until completion of the guilt phase and penalty phase/sentencing.
 - 2) Aggravated homicide cases, in which the death penalty is not sought, shall occupy the portion of a full time attorney up to a maximum of one Full Time Employee (FTE) qualified at Senior Public Defense I level or above. Up to 0.5 FTE professional support staff will be assigned to each such case. Active Supervision will be assigned at up to 0.1 FTE.
 - 3) Aggravated homicide cases, in which the death penalty is sought, shall occupy the portion of two full time attorneys, up to a maximum of two FTE attorneys, deemed necessary by the Agency to provide effective assistance of counsel. The attorney component shall comply with SPRC 2, Superior Court Special Proceedings Rules – Criminal, as well as one FTE qualified at Senior Public Defender I, or above. A professional support staff will be assigned up to one FTE. Active Supervision will be assigned at up to 0.2 FTE.
 - 4) The Agency and the County understand that the portion of attorney(s) and professional support staff assigned to each complex litigation case may change from time to time as the case moves through the adjudication process. In the event that a case concludes sooner than scheduled in Attachment B, case credit allocation will be adjusted accordingly.

f. **Involuntary Commitment practice area:**

- i. **Initial Petition:** An involuntary commitment case shall include any hearing on a petition for involuntary commitment under one cause number including a hearing for probable cause, or any petition for additional commitment under the same cause number pursuant to RCW 71.05.280, except such hearings defined in (ii) and (iii) below.
 - ii. **180-Day Petition:** Any involuntary commitment case that went to a 180-day hearing following a petition filed pursuant to RCW 71.05.320 shall be considered a separate case and shall be billed by client name and shown separately. When a new docket number is assigned and the first court appearance is a 180-day hearing, the Agency will receive case credit and payment for either the assignment of the new docket number or the 180-day hearing, but not both.
 - iii. **Involuntary Medication Hearing:** A hearing held pursuant to a petition for involuntary administration of medications or electroconvulsive therapy shall be considered a separate case.
 - iv. **An alcohol involuntary commitment proceeding filed pursuant to RCW 70.96A including all hearings under the same cause number shall be considered one case.**
 - v. **A drug-related involuntary commitment filed pursuant to RCW 70.96A including all hearings under the same cause number shall be considered one case.**
- g. **Juvenile Offender practice area: Coverage for all juvenile cases filed in juvenile court, including Diversion Calls.**
- i. **Juvenile Offender Case:** A juvenile offender case includes any criminal charge filed by the King County Prosecutor's Office in King County Juvenile Court. A restitution hearing is included within the initial case credit.
 - ii. **Juvenile Offender Modification/Review:** A juvenile offender modification/review shall include a hearing or hearings related to the allegations contained in the notice of the modification/review. In the event that the juvenile respondent has several notices of modification/review because of different cause numbers and all such modifications/reviews are heard at a single hearing, then such hearing shall constitute one completed juvenile offender modification/review.
 - iii. **Juvenile Offender Restitution Review Hearing:** A juvenile offender restitution review hearing consists of a hearing or hearings related to the subsequent modification of restitution schedules set by the court for the particular juvenile offender. In the event that the juvenile has several pending restitution hearings and such hearings are all heard at the same hearing, then such completed hearing shall constitute one completed restitution review hearing.

- h. Misdemeanor practice area:
 - i. Misdemeanor Case: Any criminal case, including traffic misdemeanors, filed by the King County Prosecutor in the District Courts.
 - ii. Misdemeanor Appeal: A misdemeanor appeal involves filing the notice of appeal, if necessary, perfecting the record following the filing of the notice of appeal, preparation of the transcript pursuant to Rule 6.3a Rules for Appeal of Decisions of Courts of Limited Jurisdiction (RALJ), preparing such briefs and memoranda as are required, arguing the case in Superior Court, and handling such paperwork as the Superior Court's decision and orders direct.
 - iii. Misdemeanor Writ: A writ involves filing notice, perfecting the record, preparing such briefs and memoranda as required, arguing the case in Superior Court and handling such paperwork as the Superior Court's decision and orders direct.
 - i. Sexual Predator practice area: Legal representation for indigent persons assigned by OPD for cases filed under RCW 71.09, civil commitment petitions filed by the King County Prosecuting Attorney or the Attorney General's Office, subject to such conditions stated in the current Program Agreement, and General Terms Agreement between the County and the State of Washington Department of Social and Health Services (DSHS) from the effective date of these agreements, and directly invoice to and be reimbursed by DSHS at a rate determined by DSHS or as ordered by the Court.
 - j. Specialty Court practice area:
 - i. Specialty Court/Drug Court: Any criminal case filed into King County Superior Court Drug Court. Staffing is determined by a separate agreement, which is incorporated by reference herein.
 - ii. Specialty Court/District Mental Health Court includes: Any case filed into King County District Mental Health Court. Staffing is determined by a separate agreement, which is incorporated by reference herein.
2. Case Credit: Case credit is a unit of work. The total number of units that an attorney is expected to perform is listed in the case credit workloads of Section III. Program Requirements, of this Exhibit. Attachment A of this Exhibit defines the Case Credit Application and parameters for additional credit in extraordinary cases.

Extraordinary Case Credit: Extraordinary case types including Juvenile Felony Offender, Contempt of Court, Dependency, Termination of Parental rights, RCW 26.33.110 contested adoption termination, Reinstatement of Parental Rights, Murder, Persistent Offender, and all Adult Felony cases shall be given extra credits if the nature of the case requires such extra credits, based upon a written application from the Agency. Other case types may be approved for

extraordinary credit at the discretion of OPD. Factors entering into the awarding of extra credits shall be as according to Attachment A.

3. **Criminal Case:** A case is any one charge or series of related charges filed against one defendant/respondent in a single charging document or in the case of misdemeanors a series of charges under several charging documents, set for one court hearing that will ultimately lead to one disposition.
 - a. If a related series of charges is defined herein as a single case is subsequently set for separate disposition hearings or trials, the Agency may request additional credit for each case, which is severed from the consolidated case.
 - b. If a new case is filed on a separate incident after case has been assigned, and a new count is charged but not a new court case number, the Agency may request additional credit for each case similarly filed. An incident is defined as a criminal charge alleged to have occurred on or about a specific calendar day. Multiple offenses charged as occurring on or about the same date are considered a single incident. A maximum of three credits shall be allowed, if requested by the Agency, per charging document regardless of the number of incidents alleged. Agency may apply for Extraordinary Case Credit if appropriate.
 - c. Criminal charges alleged to have occurred on indeterminate dates or during a specified range of dates (e.g. on or between specific dates) are considered one incident. The Agency may present documentation to OPD to demonstrate that separate and discreet dates of incident were intended. Documentation should include such portions of pre-trial discovery to justify claim for separate incidents. In the event that such separate incidents are determined, a maximum of three credits shall be allowed, if requested by the Agency, per charging document.
 - d. A completed case involves all necessary legal action from arraignment through disposition. This includes the filing of a notice of appeal upon the client's request, application to proceed in *forma pauperis* on appeal, and a motion for appointment of appellate counsel.
 - e. A case remanded to the trial court for proceedings following appeal is a new case credit. The filing of an appeal (interlocutory appeal which is accepted for review by the appellate court or post-dispositional) closes the case for credit purposes.
4. **Criminal Case Disposition:** Case disposition shall mean the dismissal of charges, the entering of an order of deferred prosecution, an order or result requiring a new trial, imposition of sentence or deferral of same, or dispositional continuance and any other hearing on that cause number that occurs within 45 days of sentence, entry of an order for deferral of sentence, or dispositional continuance by District Court. Sentencing includes completed hearing on establishing restitution order. A motion to modify restitution shall be considered for additional credit if the motion occurs after 180 days.

A restitution hearing ordered at the time of original disposition shall be included as part of the case credit as defined by this disposition description. It shall

include the filing of a notice of appeal, if applicable. It shall not include a felony or misdemeanor probation review unless such review occurs within 45 days of disposition. Additionally, it shall not include any hearing ordered at the conclusion of a deferred sentence unless such hearing occurs within 45 days of sentencing.

5. **Indigent:** An indigent defendant is a person determined indigent by OPD or the Court as being eligible for a court-appointed attorney, pursuant to RCW 10.101, 13.34.090, and OPD policy. Defendants may be considered assigned until a screening for indigency is completed, pursuant to RCW 10.101.020(4). Defendants may be required to be re-screened if their financial situation changes or at each 180 days of Agency representation. If a defendant is found to be not indigent, OPD will inform the Agency and court. In the event the court removes the Agency from assignment or orders the Agency to withdraw as appointed counsel, credit for such representation by the Agency is determined by the terms of this Contract, including the relevant sections of Attachment A.
6. **Legal Services:** Legal service is legal representation provided by an individual licensed attorney, and associated professional support staff to an individual client, pursuant to a case assignment or court appointment. The attorney will be required by the Agency to satisfy the Code of Professional Responsibility, the law of the State of Washington and the United States in the full discharge of the duties to each individual client under this Contract.
7. **Professional support staff:** Investigators, social workers and paralegals.
8. **Supervision:** An attorney with significant experience who is capable of actively monitoring an attorney's work product, caseload management, and relationship with clients and is capable of providing legal advice and guidance in other areas relevant to assuring high quality staff attorney performance. The Agency will provide active supervision for each staff attorney, in the ratio of one supervisor per ten staff attorneys.

III. PROGRAM REQUIREMENTS

A. Services

1. **Case Credit Allocation and Case Assignment:**
 - a. OPD shall make reasonable efforts to maintain the Agency at the total case credit allocation and case assignment as shown on Attachment B of this Exhibit, for each quarter of the year. The quarterly case credit amounts in Attachment B are provided for planning purposes. OPD shall make reasonable efforts to distribute cases beyond variance consistent with the case credit allocation in Attachment B of this Exhibit and paragraph b. below. The variance in case distribution does not apply to calendars, specialty court agreements, complex felony cases, or Sexually Violent Predator cases.
 - b. The Agency shall accept case assignments within contracted subject areas, including case assignments above the projected variance levels. Agency refusal to accept an individual case assignment within contractual subject areas shall not in and of itself be considered a

material breach of this Contract, however the County may determine such refusal requires Agency corrective action. The County shall pay the Agency for work in excess of the variance levels according to Section IV of this Exhibit.

- c. The Agency shall accept all complex litigation cases as determined by OPD, after consultation with the Agency concerning capacity.
 - d. If the Agency has begun delivery of legal services and the defendant/respondent absconds for a period of 180 days or more, upon re-apprehension, the allocation of a new case credit shall be determined by OPD.
 - e. If the Agency is assigned to a case prior to arraignment, has not provided legal services, and the defendant fails to appear for arraignment, the case shall be returned to OPD within 30 days or as agreed with OPD, and the Agency shall be debited.
 - f. If, after initial assignment, additional charges are filed under the same cause number against the same defendant/respondent, and said charges arise out of a different allegation or series of allegations unrelated by transaction to the first charges, then additional case credit shall be granted according to paragraphs II.C.2, 3, and 4 above.
 - g. The Agency may be appointed by the court as standby counsel in pro se cases. If such appointment is made, the Agency shall receive one case credit, less previous credit assigned for case. The Agency is not necessarily expected to utilize its professional support staff for pro se case work. If professional support staff work is requested by the pro se defendant, the Agency may opt to reduce its credit allocation by 0.1 per case credit allocated by not utilizing Agency professional support staff. In the event that the Agency elects to not provide professional support staff services, then it is the responsibility of the pro se defendant to comply with OPD Expert Services protocols regarding requests for any such services as may be necessary. Standby counsel shall provide such assistance and advice as may be ordered by the court and otherwise as consistent by case law and other legal requirements, and applicable standards of attorney representation and attorney conduct, including pro se requests for expert services.
 - h. The Agency shall electronically file a Closed Case Report (Attachment D) each month with OPD which shall include all information requested in the report for the month indicated and be submitted to OPD no later than 20 days following the last day of the previous month. A case is considered closed for further credit for attorney time expended after 30 days past sentencing, or a dispositional order is filed, or upon filing of a Notice of Appeal, unless an additional court order appoints counsel.
2. Funds for payment for expert services are not included in this Exhibit. Requests for appointment for expert service shall be made following OPD procedure for allocation of expert services. The Agency must assure that its staff follows the OPD expert procedures, as agreed with OPD.

3. The Agency shall fully participate as requested by the County in Superior Court and OPD planning and responsibilities for providing services in the event of a natural disaster, a major disruption to court processes, or a pandemic. The Agency shall develop and maintain disaster plan protocols which shall include a provision for daily contact with OPD and the Courts to verify court calendars requiring counsel presence. The parties acknowledge that all such plans presume the continued ability to communicate between the Agency and OPD. OPD shall assist the Agency in coordination with the courts and general implementation of the disaster plan.

The Agency shall submit within six months of the execution of the Contract the necessary plans, procedures and protocols to respond to and recover from a natural disaster or major disruption to agency operations such as a work stoppage; and continue operations during a prolonged event such as a pandemic. The plans shall be consistent with written County disaster plans for purposes of continuation of court business in the event of a disaster.

B. Practice Standards and Records

1. The Agency shall require that all attorneys, professional support staff and supervisors maintain contemporaneous records of all legal services provided on a specific case. The records shall provide a factual description of the work done and shall be sufficiently detailed to allow monitoring of legal service activity by OPD.
2. Upon closing a case, all attorney, professional support staff and supervisor files associated with the case shall be cross referenced and accessible as a whole for OPD monitoring.
3. The Agency shall maintain professional practice standards in providing a level of legal service that does not fall below the minimum professional standards and RPCs of the Washington State Supreme Court, the Washington State Bar, the National Legal Aid & Defender Association, and any applicable case law and court rules that define the duties of counsel to their clients. The Agency shall formally adopt the internal Agency practice standards as submitted to OPD February 1, 2006, and shall include a procedure for monitoring compliance with the standard. Case credit workload standards shall be according to paragraph III.B.14. below.
 - a. Attorney practice standards, include but are not limited to:
 - i. Lawyer-client relationship, initial case actions, investigation and preparation, preliminary hearings; disposition without trial; trial; post conviction or fact finding and any other areas of attorney practice deemed appropriate by Agency management or Board.
 - ii. Attorney use of professional support staff services and expert services.
 - b. Professional support staff service practice standards.
 - c. Practice standards for supervision of attorneys and professional support staff services.

4. The Agency agrees that, within available resources, reasonable efforts will be made by the Agency to continue the initial attorney assigned to a client throughout any case in which representation is undertaken. The Agency is not prohibited from rotating attorneys through various Agency divisions or from assigning a single attorney to handle various aspects of legal proceedings for all indigent persons where such method of assignment is the most reasonable method of obtaining effective legal representation for indigent persons.
5. The Agency agrees that a member of the Agency staff shall visit any assigned in-custody criminal defendant, in-custody civil commitment, or dependency clients, and obtain basic contact and other fundamental intake information for a bond hearing within one business day from notification to the Agency of the assignment of the case and the in-custody status of the client, and/or within one business day upon notification of transport to a local detention facility. This provision applies to clients in custody at any facility within the King County jail. If a client is in custody in a non-County jail, the Agency shall make contact within three business days of receiving the assignment.
6. The Agency agrees that an attorney shall make contact with all assigned persons within five working days from a case assignment, or in rare occurrences where this is not achieved the Agency shall document reasonable efforts to make said contact.
7. The Agency agrees that a preliminary written response to any written complaints from OPD concerning services provided by the employees of the Agency or the Agency itself shall be submitted to OPD within three working days of the date the complaint is received by the Agency Director or the Director's designee. Written complaints include email communications from OPD; email response date will be provided.
8. Upon assignment of any client charged with a criminal case to an Agency, the Agency shall make diligent and reasonable efforts to obtain discovery within five business days of the assignment, whether initial or subsequent, on any case. In all cases, discovery shall be reviewed as soon as possible and in no event later than five business days after receipt for purposes of determining any conflicts of interest. The Agency shall notify OPD immediately and no later than 14 calendar days from assignment without good cause shown, of any conflict of interest as defined by the Washington State Rules of Professional Conduct. The Agency shall state the basis when possible, as court determines, for the conflict in its written notification.
9. The Agency shall establish and enforce policies and procedures to ensure that attorney time and other Agency resources funded by this Contract shall be for work, which is the subject of this Contract.

The Agency shall establish policies and procedures for pro-bono work provided by staff of the Agency. These policies and procedures shall assure that any such pro bono work is not provided to the exclusion or detriment of legal services that are the subject of this Contract.
10. Attorney Professional Support Staff

The Agency shall provide sufficient professional support staff, including investigators, social workers and paralegals to provide for effective assistance of counsel.

11. Minimum Attorney Qualifications

- a. Attorneys shall have the requisite qualifications for the cases to which they are assigned by the Agency, consistent with Washington State Bar Association (WSBA) Standards for Public Defense Services, Standard Fourteen, Qualifications for Attorneys, as adopted in 2007 and as may be amended by WSBA during the Contract period.
- b. Each staff attorney representing any client assigned by OPD shall work under the supervision of a supervising attorney employed by the Agency. Such supervision shall provide the staff attorney with sufficient resources so the attorney will be able to handle cases on his/her own. The employees of the Agency are not employees of the County and the County will not provide supervision to any of the Agency's employees.
- c. The Agency may choose to use Rule 9 Interns or Rule 8 attorneys, as allowed by Washington State Bar Association regulations.

12. Attorney/Professional Support Staff Evaluation

The Agency director, or his/her designee, shall evaluate the professional performance of each individual Agency attorney and professional support staff member annually. Attorney evaluations shall include: quality of case preparation, compliance with the requirements of this Contract, monitoring of time and caseload records, review of case files, and in-court observation.

Professional support staff evaluations shall be sufficiently comprehensive to assess the quality of the actual work performed.

The Agency shall keep a written record of all required performance evaluations.

13. Attorney/Professional Support Staff Training

The Agency shall provide access to sufficient training to support attorney and professional support staff performance of duties under this Contract. The Agency shall maintain all necessary records to assess the adequacy of the training. A Continuing Legal Education (CLE) approved by the Washington State Bar Association is presumptively adequate.

At a minimum during the Contract period, the Agency shall require each attorney to attend at least seven WSBA approved credits of CLE in a practice area under this Contract. Each Agency attorney must attend training approved by WA State OPD, pursuant to RCW 10.101.050 and as posted on WA State OPD website, at least once per calendar year. Each Agency attorney also shall satisfy the minimum requirements for practicing law in the State of Washington as determined by the Washington Supreme Court.

14. Case Credit Workload Guidelines

The County shall review Agency case credit workloads, case assignments, standards, and support staff/attorney ratios for each area of cases to assess compliance with the requirements of this Contract.

The total amount of reimbursement included in this Contract resulted from the application of the Public Defense Payment Model approved by the King County Council by Motion 12160 on July 18, 2005. Pursuant to the policies stated in Motion 12160, the allocation for each case area was calculated to provide funding for public defenders at parity with similarly situated attorneys in the Office of the Prosecuting Attorney. The Agency's staffing plan may be reviewed by OPD to verify that an attorney's experience level meets or exceeds required experience for case practice area, and placement within the salary schedule is reasonable. The Agency agrees to comply with the following average annual case credit work loads per attorney per case type:

Supervisors	0
Felony	150
Complex	150
593	150
King County Misdemeanor	450
Juvenile*	330
* KCC Motion supplemented by WA State funds (see Att C of this Exhibit) to allow effective caseload of 250	
Dependency	180
Becca	(refer to IV.H. of this Exhibit)
Contempt of Court	225
Involuntary Treatment Act (ITA)	410

A supervisor, including a managing director or assistant director, may provide minimal representation to clients under this Exhibit solely for the purpose of addressing management issues, emergencies or caseload overflow beyond the projections. OPD shall be notified of primary representation by supervisory staff constituting a caseload that exceeds available one to ten ratio of supervisory availability.

15. The Agency agrees to abide by the OPD Withdrawal procedures (Attachment E) when declining a case or withdrawing from a case because of a conflict of interest. Agency may withdraw only pursuant to applicable court rules and RPCs. Agency attorney shall promptly notify the court of any conflict of interest or any other reason requiring withdrawal from a case assigned under this Exhibit. The Agency shall submit the Withdrawal form to OPD and the case will be re-assigned by OPD upon receipt of signed Court Motion or if case is an early assignment (pre-court appointment) from OPD, OPD may re-assign the case in advance of Court appointment and/or Motion. Credits shall be applied according to the terms of this Exhibit, including Attachment A.

16. The Agency shall report all extraordinary occurrences to OPD in accordance with the Extraordinary Occurrences Policy and Procedure, and cooperate with any OPD extraordinary occurrence review. The Agency shall adopt an Agency specific extraordinary occurrence policy. The requirement to report to OPD does not replace reporting requirements by other entities.
17. The Agency shall have a process for the filing and review of complaints that are brought to the Agency's attention by clients, OPD, or other criminal justice system staff. The Agency shall establish an internal complaint procedure that is accessible to all clients, in accordance with RCW 34.05, 49.60, RPCs, and the OPD Client Complaint Services Policy and Procedure. The Agency shall maintain a file system for reliable report backup of each complaint.
18. The Agency agrees to abide by the terms of the OPD Attorney Supervision Policy and Procedures.
19. The Agency shall have an Information System (IS) that can report accurate data to OPD, and shall comply with the OPD IS Policy and Procedure. The Agency shall have functional personal computers using a Windows Operating System version 2000 or above and shall be connected to the Internet with the following supports:
 - a. The Agency shall have at least one trained primary and one trained backup on-site IS support person who has training on Basic Administration of Windows 2000, and other basic software training.
 - b. The Agency shall notify OPD, in writing, of staffing changes (i.e. new hires, transfers, and terminations) for those staff directly responsible for data reporting and IS maintenance.
 - c. If a virus attacks an Agency computer, Agency response must be immediate (i.e. within 15 minutes) to take the computer off line and other appropriate action.

IV. COMPENSATION AND METHOD OF PAYMENT

- A. The Agency shall be paid monthly as provided in Attachment C of this Exhibit except as paragraph IV B. applies. The Payment Schedule shall pertain to all cases assigned to the Agency from January 1, 2008 through December 31, 2008. The Agency shall submit reports in a format approved by the County, as stated in Section V. Reporting Requirements of this Exhibit. The reports are due within ten days after Agency receipt of the OPD Case Credit Certification Report.
- B. Payment shall be made monthly, subject to performance requirements being met and upon completion of scheduled corrective action requirements noted in the OPD 2007 site visit review and the Agency plan for corrective action. For each corrective action due date missed by the established due date, one percent of the subsequent month's payment will be withheld until action is completed or report is received and accepted by the County.
- C. Payments may be made for extraordinary expenses that are in addition to those payments shown in Attachment C, Payment Schedule. Extraordinary expenses shall be approved in writing in advance of the expenditure by OPD.

- D. In the event that workload demand exceeds the projected levels, the Agency shall accept case assignments and case credits above the variance levels on a monthly basis. OPD will monitor the distribution on a cumulative monthly basis to ensure that a reasonable distribution of cases has been maintained.
- E. For quarterly and annual payment purposes, the variance shall be no more than five percent, for all case areas except felony cases, which shall have a variance of no more than two-and-one-half percent. These variance percentages will be applied to the projected caseload to establish the variance range.
- F. Quarterly reconciliation: At the end of each quarter, OPD will evaluate the case credit accumulation for each Agency for each case type. Action taken will be as follows:
1. The actual quarterly caseload for each type of case area, as shown in the quarterly Certified Statistics will be compared to the actual variance range, for each practice area. Variance does not apply to calendars, specialty court agreements, or Sexually Violent Predator cases.
 2. If the Agency's actual quarterly caseload falls within the high and low values of the variance, an adjustment to the reimbursement will not be made.
 3. If the Agency's actual quarterly caseload falls outside of either the high or low values of the projected variance range, an adjustment to the payment may be made.
 4. If a quarterly reconciliation results in payment due to the Agency from the County, the Agency may, at the Agency's option, defer such payment to a later month in the Contract year.
 5. If the quarterly reconciliation results in payment due to the County from the Agency, the County may, at the County option, defer such payment to a later month in the Contract year.
- G. Year end reconciliation: The final payment will be the result of a reconciliation of actual performance to Contract specifications. The reconciliation will be conducted as follows:
1. The annual variance percentages outlined in Section III. Program Requirements will be applied to the projected caseload to establish the variance range.
 2. The actual annual caseload for each type of case will be compared to the variance range for each type of case, except for complex felony cases, calendars, specialty court agreements, or Sexually Violent Predator cases.
 3. If the Agency's actual annual caseload falls within the high and low values of the variance, an adjustment to December reimbursement will not be made.
 4. If the Agency's actual annual caseload falls outside of either the high or low values of the projected variance range, an adjustment to the final payment will be made.
- H. Becca Cases: The Agency shall be paid by OPD for CHINS, ARY, and Truancy legal services from funds provided by the State of Washington through King County Superior

Court, Juvenile Court Services, and such additional funds as may be made available by King County.

1. **Truancy.** Truancy cases will be counted as one credit for the filing of a truancy contempt of court where the right to counsel attaches. No additional credits will be given for review hearings.
 2. **ARY/CHINS.** ARY and CHINS cases will be counted as one credit for new assignments on a petition for ARY or CHINS. The initial case credit will include two review hearings. Review hearings after the first two on that petition will earn one third (.33) credit per review.
 3. **Review hearings.** All hearings subsequent to the hearing in which the ARY or CHINS fact finding is completed and in which disposition of the petition is ordered, if ordered in a separate hearing, will be considered a review. Any contempt hearing ordered on the original petition post disposition will be considered a review credit, if the matter is handled within the proceedings relating to the ARY or CHINS petition. Hearings relating to the contempt in the ARY or CHINS proceeding which occur post disposition of the contempt matter will be considered a review hearing.
 4. **Truancy credit load limit.** For purposes of this contract, Truancy cases will have a case credit load limit of 375 credits per FTE attorney per year.
 5. **ARY / CHINS credit load limit.** For purposes of this contract, ARY and CHINS cases will have a case credit load limit of 250 credits per FTE attorney per year.
 6. **A variance of five percent applies to Becca cases in total, as counted in aggregate in this Contract. Site specific estimates included in Attachment B are for Agency management purposes only.**
 7. **The Agency agrees to provide attorneys for the same court sessions and calendars in 2008 as it did in 2007.**
- I. **Sexual Predator cases:** The Agency shall be paid by the State of Washington for cases filed under RCW 71.09 and assigned to the Agency by OPD at a rate determined by DSHS or as ordered by the Court. Agency reimbursement shall be based on submission of expenditure reports and an invoice to DSHS in a format approved by DSHS. OPD shall apply its policies and procedures, as amended and posted on its website, to review and approve or deny requests from Agency counsel for use of Expert Services in 71.09 cases. Such authorization for Expert Services shall be made at the sole discretion of OPD. Upon approval or denial of counsel's request for Expert Services, OPD shall notify counsel. Per OPD policy, defense counsel may appeal an expert service denial to the court. Expert service reimbursement shall be invoiced to and provided directly by DSHS.
- J. **Prepayments**
1. **The Agency shall ensure that it has sufficient funds to complete prepaid cases assigned but not completed at the end of the Contract period. The Agency must report its calculated prepayment retention amount and cost estimate, include the method of calculation, and provide a conclusion about whether the funds available would cover all costs associated with completing the cases**

assigned and prepaid. Not having an adequate reserve shall not be cause for a material breach of contract, but may require Agency corrective action.

2. In the absence of a precise calculation of prepayments by the Agency, the County shall estimate the sufficiency of funds using the following formula:

For all felony, misdemeanor, initial dependency assignments, and juvenile offender cases assigned during October, November, and December that remain open at year-end, it is assumed that October cases are 75 percent completed, November cases are 50 percent completed, and December cases are 25 percent completed. For dependency cases it is assumed October cases are 15 percent completed, November cases are ten percent completed, and December cases are five percent completed.

The estimation shall be the result of calculating the number of open cases for each month by the corresponding percentage of uncompleted work, and then determining the sum of the uncompleted case count by the per case revenue amount to determine the sufficiency of funds.

V. REPORTING REQUIREMENTS

Compliance with the terms of this Exhibit requires the following reports, in a format approved by the County, to be submitted at the times indicated in the chart below.

Report Title	2008 Due Date
Closed Case Reports Persistent Offender (593) Monthly Case Report Additional Credit forms Monthly Expenditure Reports Complex Litigation time sheets Extraordinary Case Credit requests	Monthly, or more frequently if necessary
Year-end Attorney Case Assignment Report	January
Agency Disaster Plan	June
Annual Financial Statements, IRS Form 990, Audit Report including management letters.	August
Additional summaries, reports or documents, corrective actions directly related to Contract performance, as requested by OPD with reasonable notice.	Varies

ATTACHMENT A

Case Credit Application Schedule

Type of Case	
██████	
One completed case	One case credit
Atty/Day or substantial advice	.10 case credit
Atty/Day or substantial advice in the King County Detention Facility	.20 case credit
Probation, other reviews, or sentencing only	.33 case credit
Assignment for Motion to Withdraw Guilty Plea or a Motion for New Trial based on a claim of ineffective assistance of counsel	One case credit
Murder 1	Two case credits upon assignment
Murder 2	Two case credits upon assignment
Persistent Offender (593)	<p>One case credit upon assignment, less previously assigned felony credit. The Agency is eligible for additional case credit for each additional 12.1 hours or portion thereof of attorney time on the case according to the Extraordinary Cases section of this Attachment A. The Agency shall report monthly to OPD the total attorney time in each persistent offender case in a format consistent with Attachment F categorizing attorney hours. It is understood that the Agency director or the director's designee will review the status of all pending persistent offender cases in the Agency at least monthly and will discuss the cases with the attorneys representing the clients. Such review will include the status of investigation, preparation and presentation of mitigation packages, legal and factual issues in the case, the client's physical and mental status, and any plea bargaining offers.</p> <p>This reimbursement method shall be in place until such time as the King County Council approves, by motion, a change in reimbursement methodology, and such time when the Council approved change is amended to this Contract.</p>
Felony Bench Warrant during case	One case credit if more than 180 days has passed since the date of the bench warrant and if the bench warrant was on a new case assignment; or 0.33 case credit if warrant was a probation review or other hearing valued at 0.33 credit.

Type of Case	
Case transferred to another agency, assigned counsel, or retained counsel	Substantial advice credit if case is not completed prior to transfer and if Agency provides to OPD satisfactory justification for credit. In the event that award of substantial advice credit alone results in a substantial financial hardship to the Agency, the Agency may request additional credit. Factors to be considered for additional credit include advanced stage of proceedings (e.g. set for plea, set for or approaching trial date, substantial amount of work expended).
Case transferred to drug court	One case credit
Complex Litigation	
Capital cases	Two FTE attorneys; 25 complex litigation case credits per month maximum plus support staff as approved.
Aggravated Homicide	One FTE attorney; 12.5 complex litigation case credits per month maximum.
King County Misdemeanor	
One completed case, King County District Court	One case credit
District Court review, revocation, re-sentencing or other hearing	One case credit
One District Court expedited felony	One case credit
Misdemeanor Appeal	Four case credits
Misdemeanor Writ	Three case credits
Atty/Day or substantial advice; excludes misdemeanor beeper calendar matters listed in Attachment B and other calendar representation.	0.10 case credit
Atty/Day or substantial advice for in-custody clients; excludes misdemeanor beeper calendar matters listed in Attachment B and other calendar representation.	0.20 case credit
Decline Hearing	
One completed case	One case credit
Decline hearing	One case credit

Type of Case	
Reviews	0.33 case credit
Atty/Day or substantial advice	0.10 case credit
Dependency	
A dependency case	One case credit
Post Disposition Review Hearing	0.40 case credit
Dependency trial	0.50 case credit
Termination trial	One case credit
Atty/Day for substantial advice	0.10 case credit
Representation of Parents	
Child and/or parent may be represented	One case credit
Contempt	
From show cause initial assignment hearing up to and including two contempt reviews	One case credit
Subsequent reviews	0.33 case credit
Other Child's Best Interest	One case credit for one completed case – petition through closure.
IA	One case credit
Dispositive Hearing	Calendar funding
Dispositive Hearing	Calendar funding
Dispositive Hearing	
New statutory mandates	Case types not contemplated by this Contract arising from legislation with effective dates after January 1, 2007 shall be assigned by OPD and accepted by the Agency subject to agreement on the credit to be given.

Type of Case	
Extraordinary Cases	<p>Extraordinary Juvenile Felony Offender, Dependency, Termination of Parental Rights, RCW 26.33.110 contested adoption termination, Reinstatement of Parental Rights, Murder, Persistent Offender, and all Adult Felony cases shall be given extra credits if the nature of the case requires such extra credits, based upon a written application from the Agency for additional credits and negotiation between OPD and the Agency. Factors entering into the awarding of extra credits include, but are not limited to: seriousness of the charges; amount and complexity of evidence; number of witnesses; unusual legal issues; number of defendants; whether there is a plea, bench trial or jury trial; number of pre-trial motions or hearings needed; severity of the consequences; and actual length of trial.</p> <p>The Agency application must be specific about the work to be done or completed to date, the estimated length of time to perform the work, and the personnel that will be assigned to perform the work. Initial OPD response to the Agency, including requests for additional information, shall be made within five business days from OPD receipt of Agency application.</p>
Credit for cases where the Agency withdraws due to a conflict of interest	<p>When the Agency has reviewed discovery and reported to OPD its withdrawal for reason of conflict and requested credit for time expended, OPD shall review the Agency's request for credit, including the reason given for withdrawal and may grant appropriate credit. Should such credit be denied, OPD shall inform the Agency of the basis for denial.</p>
Pro Se/Standby Counsel	<p>One case credit if professional support staff work is performed by the Agency and requests for appointment of professional support staff at public expense outside of the Agency are not submitted to OPD. If professional support staff work is requested by the pro se defendant, the Agency may inform OPD that it is opting to reduce its credit allocation by 0.1 per attorney credits assigned in the case by not utilizing its professional support staff.</p>

ATTACHMENT B

Agency Case Credit Allocation and Cases Assigned Estimate for January - December 2008

Case Category	Total Agency Case Credit Allocation	Agency's % of Total OPD Case Credits	1st Quarter	2nd Quarter	3rd Quarter	4th Quarter
<i>Felony & 593s</i>	2,066.0	19%	516.0	517.0	517.0	516.0
<i>Complex</i>		0%				
Total Felony	2,066.0		516.0	517.0	517.0	516.0
KC Misd	2,033.0	24%	508.0	508.0	509.0	508.0
Juv Off	292.0	7%	73.0	73.0	73.0	73.0
Dependency	552.0	17%	138.0	138.0	138.0	138.0
Contempt of Court	489.0	20%	122.0	122.0	122.0	123.0
Becca (new cases)		0%				
TOTAL	5,432.0	16%	1,357.0	1,358.0	1,359.0	1,358.0

2008 Calendar Attorney and Staff List

Case Area	KCCF	RJC	Calendar	Agency	Day	Time	Atty	Staff	Supv.
NDA has no calendar staffing.									

ATTACHMENT C

Payment Schedule

This Payment Schedule shall pertain to all cases assigned to the Agency from January 1, 2008 to December 31, 2008. In 2008, the Agency shall be paid the following monthly amounts for cases and special services:

2008	Jan Payment	Feb Payment	Mar Payment	Apr Payment	May Payment	Jun Payment
Felony (regular & 593s)	192,103	192,103	192,103	192,103	192,103	192,103
Felony (complex) ^a						
Juvenile	12,150	12,150	12,150	12,150	12,150	12,150
King County Misdemeanor	62,219	62,219	62,219	62,219	62,219	62,219
Dependency	42,690	42,690	42,690	42,690	42,690	42,690
Contempt of Court	28,760	28,760	28,760	28,760	28,760	28,760
Agency Admin & Overhead:						
Administration	27,329	27,329	27,329	27,329	27,329	27,329
Indirect Cost	15,944	15,944	15,944	15,944	15,944	15,944
Rent	29,614	29,614	29,614	29,614	29,614	29,614
Total Agency Admin & Overhead	72,887	72,887	72,887	72,887	72,887	72,887
Becca	0	0	0	0	0	0
Juvenile 10.101 ^c	4,226	4,226	4,226	4,226	4,226	4,226
NDA TOTAL	415,035	415,035	415,035	415,035	415,035	415,035

2008	Jul Payment	Aug Payment	Sep Payment	Oct Payment	Nov Payment	Dec Payment	TOTAL Jan-Dec 2008
Felony (regular & 593s)	192,103	192,103	192,103	192,103	192,103	192,096	2,305,229
Felony (complex) ^a							^b
Juvenile	12,150	12,150	12,150	12,150	12,150	12,154	145,804
King County Misdemeanor	62,219	62,219	62,219	62,219	62,219	62,236	746,645
Dependency	42,690	42,690	42,690	42,690	42,690	42,679	512,269
Contempt of Court	28,760	28,760	28,760	28,760	28,760	28,729	345,089
Agency Admin & Overhead:							
Administration	27,329	27,329	27,329	27,329	27,329	27,327	327,946
Indirect Cost	15,944	15,944	15,944	15,944	15,944	15,945	191,329
Rent	29,614	29,614	29,614	29,614	29,614	29,617	355,371
Total Agency Admin & Overhead	72,887	72,887	72,887	72,887	72,887	72,889	874,646
Becca	0	0	0	0	0	0	0
Juvenile 10.101 ^c	4,226	4,226	4,226	4,226	4,226	4,225	50,711
NDA TOTAL	415,035	415,035	415,035	415,035	415,035	415,008	4,980,393

^a Payment is made on a per credit basis for cases open during the month.

^b This total amount is estimated in consideration of cases open at the beginning of the contract. The actual annual amount may be greater or lesser depending upon new case assignments and the timing of case closing for existing cases.

^c Public Defense Improvement Fund from the Washington State Office of Public Defense.

**ATTACHMENT E
NOTIFICATION OF WITHDRAWAL**

PLEASE PRINT OR TYPE

Date: _____

Client Name: _____ AKA: _____

Address: _____ Phone: _____

DOB: _____ JCN: _____ CCN: _____

Cause Number: _____ Charge: _____

Case Type: Felony Seattle Municipal Juvenile
 Dependency Civil Contempt KC Misdemeanor
 ITA Other _____

REASON FOR WITHDRAWAL:
 Conflict of Interest Other _____

Defendant Retained Private Counsel: **(Name of Attorney)** _____

CONFLICT INFORMATION:

This Agency's conflict is with: Name _____ DOB: _____

Cause Number: _____ Co-Defendant in Current Case? Yes No

Victim/Client Suspect/Client Witness/Client Other _____

OTHER NAMES IN DISCOVERY:

NAMES	DOB	STATUS IN CASE	REPRESENTATION HISTORY

SEE ATTACHED SHEET FOR ADDITIONAL LISTINGS

In-Custody Out-of-Custody Received Conflict From: _____

HEARING SCHEDULE:
 Trial Date: _____ Next Hearing: _____ Type of Hearing: _____

*Withdrawal Hearing Date: _____
 *(MUST BE TWO FULL WORKING DAYS FROM IDENTIFICATION OF CONFLICT IF TRIAL DATE HAS BEEN SET. AGENCY MUST NOTIFY PA AND CO-DEFENDANT COUNSEL.)

LOCATION OF DISCOVERY:
 PA's Office Agency will forward to new counsel Other _____

Request for credit/debit: _____

This form filled out by: _____ Date: _____

APPROVED BY: _____ Date: _____

OPD USE ONLY
 OPD REASSIGNED TO: _____ INITIALS: _____ DATE: _____

FAX Interoffice Mail

ATTACHMENT F

[Agency] Persistent Offender (593) Monthly Case Report

Client Name: _____
 Cause No.: _____
 Month/Year: _____
 Attorney(s): _____

Week (Dates)	Attorney (1)	Attorney (2) (if assigned)	Total Atty.	Invest	Social Wkr.	Paralegal	Total Support	Total Week	Total to Date
/ to /									
/ to /									
/ to /									
/ to /									
/ to /									
TOTAL									

NOTE: 12.1 hours = 1.00 credit

Abbreviations must be used to categorize attorney hours:

- CC = Contact with Client
- R = Legal Research
- Ptr = Pretrial Hearing
- Tr = Trial
- S = Sentencing/Disposition
- CP = Case Prep
- C = Confer with attorney/investigator/social worker/paralegal
- N/A = No second attorney assigned

16404

Attachment C

King County Contract No. D37886D
Federal Taxpayer ID No. 91-0984541

Department/Division Community and Human Services/Office of the Public Defender
Agency Society of Counsel Representing Accused Persons
Project Title Public Defense Legal Services
Contract Amount \$9,834,757.50 Fund Code 00000010
Contract Period From: January 1, 2008 To December 31, 2008

KING COUNTY AGENCY SERVICES CONTRACT – 2008

THIS CONTRACT is entered into by KING COUNTY (the "County"), and Society of Counsel Representing Accused Persons, whose address is 1401 East Jefferson, Suite 200, Seattle, WA 98122, (the "Agency").

WHEREAS, the County desires to have legal services, as described in the Contract, performed for indigent persons legally entitled to appointed counsel in King County courts and as authorized by Ordinance No. 15652; and

WHEREAS, the Agency is a nonprofit law firm, incorporated under the Washington Nonprofit Corporation Code, within the meaning of Section 501(c)(3) of the Internal Revenue Code, organized and operated exclusively for the purpose of providing court-appointed legal services to indigent persons; and

WHEREAS, the County and the Agency agree that these legal services are provided by an independent contractor non-profit corporation, possessing all of the rights, duties and obligations that are possessed under Washington State law and applicable Federal laws for an independent contractor service provider; and

WHEREAS, the County and the Agency agree that any and all funds provided pursuant to this Contract are provided for the sole purpose of provision of legal services to indigent persons assigned to the Agency by the County Office of The Public Defender (OPD) or the courts of King County.

NOW THEREFORE, in consideration of payments, covenants, and agreements hereinafter mentioned, to be made and performed by the parties hereto, the parties covenant and do mutually agree as follows:

I. SCOPE OF SERVICES

The Agency shall provide services and comply with the requirements set forth hereinafter and in the following attached exhibits, which are incorporated herein by reference:

This form is available in alternate formats for people with disabilities upon request.

- Certificate of Insurance/Endorsements Attached hereto as Exhibit I
- Personnel Inventory Report Attached hereto as Exhibit II
- Affidavit of Compliance Attached hereto as Exhibit III
- 504/ADA Assurance of Compliance Attached hereto as Exhibit IV
- Public Defense Legal Services Attached hereto as Exhibit V

II. DURATION OF CONTRACT

This Contract shall commence on the 1st day of January 2008, and shall terminate on the 31st day of December 2008 ("Contract Term"), unless terminated earlier, pursuant to the terms and conditions of the Contract. This Contract may be extended by agreement of the parties for a period of up to three months in order to complete negotiations and/or receive necessary approval of a subsequent year contract. An amendment to extend the contract duration may reflect adjustments to payment and casework schedule reflective of planned changes for subsequent year.

III. COMPENSATION AND METHOD OF PAYMENT

- A. The County shall pay the Agency for satisfactory performance of the services and requirements specified in this Contract, payable in the following manner:

As defined in Exhibit V, Section IV, for Public Defense Legal Services.

- B. The Agency shall submit all outstanding reports within 20 days of the date this Contract terminates. If any of the Agency's reports which are due to the County are not submitted by the day specified in this subsection, the County may withhold payment to the Agency until such time as reports are submitted and approved.

IV. OPERATING BUDGET

The funds provided by the County to the Agency pursuant to the terms of this Contract are solely for expenses that are directly and legitimately related to the performance of the provisions of this Contract. In the event the County, determines that funds paid pursuant to this Contract were expended for any purposes other than those set forth in this Contract, such expenditure shall constitute a material breach of this Contract. Income and expenses, including prorated overhead costs, for Sexually Violent Predator cases and any other services funded by the State DSHS shall be reported and traceable in a method consistent with accounting standards noted below. If the Agency receives any revenue from any other source, the costs paid, including prorated overhead, for work done with that revenue shall be reported and traceable according to the accounting standards noted below.

V. INTERNAL CONTROL AND ACCOUNTING SYSTEM

The Agency shall establish and maintain a system of accounting and internal controls that comply with generally accepted accounting principles and financial reporting standards applicable to publicly supported not-for-profit corporations as prescribed by the Financial Accounting Standards Board.

VI. MAINTENANCE OF RECORDS

- A. The Agency shall maintain accounts and records, including personnel, property, financial, and programmatic records and other such records as may be deemed necessary by the County to ensure proper accounting for all Contract funds and compliance with this Contract.
- B. These records shall be maintained for a period of six years after termination hereof unless permission to destroy them is granted by the Office of the Archivist in accordance with Revised Code of Washington (RCW) Chapter 40.14.
- C. The Agency shall inform the County in writing of the location, if different from the Agency address listed on page one of this Contract, of the aforesaid books, records, documents and other evidence and shall notify the County in writing of any changes in location within ten working days of any such relocation.

VII. AUDITS

- A. The Agency shall have an independent audit, conducted by a certified public accountant, of its financial statement and condition, which shall comply with generally accepted auditing standards for not-for-profit organizations as prescribed by the American Institute of Certified Public Accountants. The independent auditor's report shall include a management letter listing any reportable conditions or internal control weaknesses, or stating that no reportable conditions or control weaknesses were noted. The auditor's report shall include a copy of the Agency's management representation letter. Any independent auditor hired by the Agency to fulfill the Contract audit requirements must agree to provide access to audit working papers if requested by the County.
- B. The Agency shall provide a copy of the audit report to each County division providing financial assistance to the Agency no later than the last business day of August. The Agency fiscal year shall be the same as a calendar year. The Agency shall provide to the County its response and corrective action plan for all findings and reportable conditions contained in its audit. The Agency shall provide the County with a copy of its IRS Form 990 (Return of Organization Exempt from Tax) when it is filed with the IRS.
- C. The Agency's annual financial statements shall be prepared recognizing all Agency fund accounts at the end of the Contract Term.
- D. Any and all accounts must be invested in a fiscally prudent fashion under the non-profit corporation law of Washington and applicable Federal laws. Prepayments, as noted in Exhibit V, Section IV, J shall be invested in a cash equivalent account, defined as a highly liquid, short term investment with little risk of loss in value.
- E. Additional federal and/or state audit or review requirements may be imposed on the County, and to the extent that such requirements relate to funding that is passed on to the Agency, the Agency shall be required to comply with any such requirements. The County shall notify the Agency when requirements from funders are issued to the County.

VIII. EVALUATIONS AND INSPECTIONS

- A. Upon reasonable notice, the Agency shall provide right of access to its facilities, including those of any subcontractor, to the County, the state, and/or federal agencies

or officials at all reasonable times for the purpose of monitoring and evaluating the services provided under this Contract. The County shall give advance notice to the Agency in the case of fiscal audits to be conducted by the County.

- B. The records and documents with respect to all matters covered by this Contract, not including entire individual personnel files but may include specific requested documentation, shall be subject to inspection, review, or audit by the County (and to the extent Contract funds paid by the County are derived from federal and/or state sources, also by federal and/or state officials so authorized by law) during the Contract Term and six years thereafter, unless a longer record retention period is required by law and in such case, the right of inspection shall extend until the end of the applicable retention period.
- C. The Agency agrees to cooperate with the County or its agent in the evaluation of the Agency's performance under this Contract and to make available all information reasonably required by any such evaluation process or ongoing reporting requirements established by the County. The results and records of said evaluations and reports shall be maintained and disclosed in accordance with RCW Chapter 42.17.

IX. CORRECTIVE ACTION

The County and Agency agree that when operational or performance issues arise in the course of providing the services of this Contract, a resolution of an issue or concern will be attempted at the lowest administrative level possible, although generally contact with the Agency shall include the managing director.

If the County determines that a performance concern has not been rectified at a less formal level and/or that a breach of contract has occurred, that is, the Agency has failed to comply with any terms or conditions of this Contract or the Agency has failed to provide in any manner the work or services agreed to herein, and if the County deems said breach to warrant written corrective action, the following sequential procedure shall apply:

- A. The County shall notify the Agency in writing of the nature of the breach;

The Agency shall respond in writing within three working days of its receipt of such notification, which response shall indicate the steps being taken to correct the specified deficiencies. The corrective action plan shall specify the proposed completion date for bringing the Agency into Contract compliance, which date shall not be more than 30 days from the date of the County's approval of the Agency's plan, unless the County, at its sole discretion, specifies in writing an extension in the number of days to complete the corrective actions;
- B. The County shall notify the Agency in writing of the County's determination as to the sufficiency of the Agency's corrective action plan within ten days of receipt, or longer with written notification to the Agency. The determination of sufficiency of the Agency's corrective action plan shall be at the sole discretion of the County, provided that the County shall take into consideration the reasonableness of the proposed corrective action in light of the breach;
- C. In the event that the Agency does not respond within the appropriate time with a corrective action plan, or the Agency's corrective action plan is determined by the County to be insufficient, the County may commence termination of this Contract in whole or in part pursuant to Section XI.A. if the breach is material;

- D. In addition to and not in lieu of any of its other contractual or legal rights or remedies, the County, in its sole discretion, may withhold any payment owed the Agency hereunder or prohibit the Agency from incurring additional financial obligations, except to the extent such obligations are required by court order or deemed by the County as necessary for the competent and adequate representation of indigent persons assigned to the Agency, until the County is satisfied that corrective action has been taken or completed; and
- E. The County may choose to use corrective action in response to any type of breach by the Agency. The choice of corrective action or termination under Section XI for a material breach is within the County's sole discretion. Nothing herein shall be deemed to affect or waive any rights the parties may have pursuant to Section XI. Nor shall the exercise of any right within this section be deemed to be a breach of this Contract by the County.

X. ASSIGNMENT/SUBCONTRACTING

- A. The Agency shall not assign or subcontract any portion of the Legal Services, as defined in Exhibit V, supervision or training which is provided under this Contract or transfer or assign any claim arising pursuant to this Contract without the written consent of the County. Said consent must be sought in writing by the Agency not less than 15 days prior to the date of any proposed assignment. The definition of training, within this subsection only, does not include CLE's. The Agency may contract for training services up to a cumulative amount of \$10,000.00 in a contract year, without seeking consent of the County. These excluded contracts and CLE costs must be reported to the County, as noted in Paragraph X. B. of this Section.
- B. The Agency shall keep all records of any contracts or purchases of goods or services related to this Contract. The Agency shall be required to report these expenditures to the County and the original records may be subject to audit at the County's request.

XI. TERMINATION

- A. The County may terminate this Contract, in whole or in part, upon seven days advance written notice in the event: (1) the Agency breaches any material duty, obligation, or service required pursuant to this Contract, (2) the Agency or any of its officers, directors, employees, subcontractors, agents or representatives engages in the misappropriation or mismanagement of Contract funds or the fraudulent disbursement of Contract funds, (3) the Agency or any of its officers, directors, agents, representatives or designees makes a material misrepresentation regarding the Agency, its finances and/or scope of activities to its independent accountant, auditor, the County, and/or any other agencies or instrumentalities of the federal, state or local government or commits any act or omission that jeopardizes the Agency's tax-exempt status under Code section 501(c)(3) or (4) the duties, obligations, or services required herein become impossible, illegal, or not feasible. The County's termination notice does not bar the Agency from seeking injunctive relief or any other equitable relief available under current Washington State law.

If the Contract is terminated by the County pursuant to (1), (2), or (3) in the first paragraph of XI. A., the Agency shall be liable for damages, including any additional reasonable costs of procurement of similar services from another source.

In the event the County terminates the Contract due to (1), (2), or (3) in the first paragraph of XI. A., or any act or omission which jeopardizes the Agency's tax-exempt

status under IRS Code Section 501(c)(3), then subject to the provisions of this Section, the Agency shall return to the County any funds misappropriated and paid to the Agency by the County under the current Contract and from any available source, including funds from a prior contract. In addition, the Agency shall return such funds determined by the County to be reasonable and necessary to provide legal services, as defined in Exhibit V, for the balance of the Contract term, or until the County is able to obtain a successor agency to provide such services, whichever period is less. This provision and the obligations contained herein shall survive the termination or expiration of this Contract.

The Agency may terminate this Contract, in whole or in part, prior to the end of the Contract Term, by providing the County seven days advance written notice, in the event the County commits any material breach of this Contract caused by non-payment or partial termination of caseload area or geographic location of services by the County without a negotiated amendment.

- B. In the event of the termination of this Contract the Agency shall remit any unexpended balance of funds paid, including prepaid funds for cases assigned and not completed, less the amount the County and the Agency agree shall be necessary to enable the Agency to deliver services in those cases notwithstanding the termination. Nothing herein shall limit, waive, or extinguish any right or remedy provided by this Contract or law that either party may have in the event that the obligations, terms, and conditions set forth in this Contract are breached by the other party.
- C. If County expected or actual funding is withdrawn, reduced, or limited in any way prior to the termination date set forth above in Section II, the County may, upon 15 days written notification to the Agency, terminate this Contract in whole or in part.

If the Contract is terminated as provided in this Subsection: (1) the County shall be liable only for payment in accordance with the terms of this Contract for services rendered prior to the effective date of termination; and (2) the Agency shall be released from any obligation to provide such further services pursuant to the Contract as are affected by the termination.

- D. This Contract may be terminated for convenience by either party, prior to the date specified in Section II, by providing 60 days advance written notice of the termination.

XII. DISPUTE RESOLUTION

Agency disputes pertaining to County decisions regarding Contract compliance issues shall be made in writing to The Public Defender. The written dispute shall include the decision being questioned and the point on which the dispute is made. This is a non-exclusive remedy.

The Public Defender shall make a determination decision and respond in writing to the Agency within 15 days of receipt. If the Agency wishes to appeal The Public Defender decision, an additional letter indicating all points of the dispute resolution process to date shall be sent to the Director of the Department of Community and Human Services. The Department Director shall make a final determination and respond in writing to the Agency within 30 days of the Department Director's Office receipt of the appeal notice from the Agency.

Nothing herein shall impair the procedure of Section IX above nor the ability of either party to terminate this Contract as set forth in Section XI above.

XIII. FUTURE SUPPORT

- A. The County makes no assurance or commitment to the Agency for a subsequent contract or extension of the effective dates of the Contract for the services contracted for herein. Funding or obligation under this Contract beyond the current appropriation year is conditional upon appropriation by the County Council of sufficient funds to support the activities described in the Contract. Should such appropriation not be approved, this Contract shall terminate at the close of the current appropriation year.
- B. Should the County or Agency terminate this Contract or not renew this Contract for services in a subsequent period, the County shall work with the Agency to provide appropriate transition planning for assigned Agency clients to ensure their defense is not jeopardized by actions of the Agency or the County.

XIV. HOLD HARMLESS AND INDEMNIFICATION

- A. In providing services under this Contract, the Agency is an independent contractor, and neither it nor any of its officers, directors, employees, subcontractors, agents, or representatives are employees of the County for any purpose. The Agency shall be responsible for all federal and/or state tax, industrial insurance, and Social Security liability that may result from the performance of and compensation for these services and shall make no claim of career service or civil service rights which may accrue to a County employee under state or local law.

The County assumes no responsibility for the payment of any compensation, wages, benefits, or taxes, by, or on behalf of the Agency, its employees, and/or others by reason of this Contract. The Agency shall protect, indemnify, and save harmless the County, its officers, officials, agents, and employees from and against any and all claims, costs, and/or losses whatsoever occurring or resulting from (1) the Agency's failure to pay any such compensation, wages, benefits, or taxes, and/or (2) the supplying to the Agency of work, services, materials, or supplies by Agency employees or other suppliers in connection with or support of the performance of this Contract.

- B. The Agency further agrees that it is financially responsible for and shall repay the County all amounts determined by a fiscal audit exception which occur due to the negligence, intentional act, and/or failure, for any reason, to comply with the terms of this Contract by the Agency, its officers, directors, employees, subcontractors, agents, and/or representatives.
- C. Should it become necessary to institute legal action in order to recoup any funds due and owing to the County or the Agency pursuant to any of the terms of this Contract, the non-prevailing party agrees it is financially responsible and liable for the prevailing attorneys' fees and costs. Each party's duty to repay shall not be diminished or extinguished by the prior termination of the Contract pursuant to any provision hereof.
- D. The Agency shall protect, defend, indemnify, and save harmless the County, its officers, officials, employees, and agents from any and all costs, claims, judgments, and/or awards of damages, arising out of, or in any way resulting from, the negligent acts or omissions of the Agency, its officers, directors, employees, subcontractors, agents, and/or representatives in performance and/or non-performance of its obligations under this Contract. The Agency agrees that its obligations under this subparagraph extend to any claim, demand, and/or cause of action brought by, or on behalf of, any of its employees or agents. For this purpose, the Agency, by mutual

negotiation, hereby waives, as respects the County only, any immunity that would otherwise be available against such claims under the Industrial Insurance provisions of Title 51 RCW. In the event the County incurs any judgment, award, and/or cost arising therefrom including attorneys' fees to enforce the provisions of this article, all such fees, expenses, and costs shall be recoverable from the Agency.

- E. The County shall protect, defend, indemnify, and hold harmless the Agency, its officers, directors, employees, agents, and representatives from any and all costs, claims, judgments, and/or awards of damages, arising out of, or in any way resulting from, the negligent acts or omissions of the County, its officers, officials, employees, or agents. The County agrees that its obligations under this subparagraph extends to any claim, demand, and/or cause of action brought by, or on behalf of, any of its employees or agents. For this purpose, the County, by mutual negotiation, hereby waives, as respects the Agency only, any immunity that would otherwise be available against such claims under the Industrial Insurance provisions of Title 51 RCW. In the event the Agency incurs any judgment, award, and/or cost arising therefrom including attorneys' fees to enforce the provisions of this article, all such fees, expenses, and costs shall be recoverable from the County.

Claims shall include, but not be limited to, assertions that the use or transfer of software, book, document, report, film, tape, or sound reproduction or material of any kind, delivered hereunder, constitutes an infringement of any copyright, patent, trademark, trade name, and/or otherwise results in unfair trade practice.

- F. To the extent that an Agency subcontractor fails to satisfy its obligation to defend and indemnify the County as detailed in Section XVIII.B. of this Contract, the Agency shall protect, defend, indemnify, and hold harmless the County, its officers, employees and agents from any and all costs, claims, judgments, and/or awards or damages arising out of, or in any way resulting from, the negligent act or omissions of the Agency's subcontractor, its officers, employees, and/or agents in connection with or in support of this Contract.
- G. Nothing contained within this provision shall affect and/or alter the application of any other provision contained within this Contract.

XV. INSURANCE REQUIREMENTS

- A. By the date of execution of this Contract, the Agency shall procure and maintain for the duration of this Contract, insurance against claims for injuries to persons or damages to property which may arise from, or is in connection with, the performance of work hereunder by the Agency, its agents, representatives, employees, and/or subcontractors. The costs of such insurance shall be paid by the Agency or subcontractor. The Agency must furnish separate certificates of insurance and policy endorsements for each subcontractor as evidence of compliance with the insurance requirements of this Contract. The Agency is responsible for ensuring compliance with all of the insurance requirements stated herein. Failure by the Agency, its agents, employees, officers, and or subcontractors, to comply with the insurance requirements stated herein shall constitute a material breach of this Contract.

For All Coverages: Each insurance policy shall be written on an "occurrence" form; except that insurance on a "claims made" form may be acceptable with prior County approval.

If coverage is approved and purchased on a "claims made" basis, the Agency warrants continuation of coverage, either through policy renewals or the purchase of an extended discovery period, if such extended coverage is available, for not less than three years from the date of Contract termination, and/or conversion from a "claims made" form to an "occurrence" coverage form.

By requiring such minimum insurance, the County shall not be deemed or construed to have assessed the risks that may be applicable to the Agency under this Contract. The Agency shall assess its own risks and, if it deems appropriate and/or prudent, maintain greater limits and/or broader coverage.

Nothing contained within these insurance requirements shall be deemed to limit the scope, application and/or limits of the coverage afforded by said policies, which coverage shall apply to each insured to the full extent provided by the terms and conditions of the policy(s). Nothing contained within this provision shall affect and/or alter the application of any other provision contained within this Contract.

B. Minimum Scope of Insurance

Coverage shall be at least as broad as:

1. General Liability:

Insurance Services Office form number (CG 00 01 Ed. 11-88) covering **COMMERCIAL GENERAL LIABILITY**.

2. Professional Liability:

Professional Liability, Errors, and Omissions coverage. In the event that services delivered pursuant to this Contract either directly or indirectly involve or require professional services, Professional Liability, Errors, and Omissions coverage shall be provided. "Professional Services", for the purpose of this Contract section, shall mean any services provided by a licensed professional or those services that require a professional standard of care.

3. Automobile Liability:

In the event that services delivered pursuant to this Contract require the use of a vehicle or involve the transportation of clients by Agency personnel in Agency-owned vehicles or non-owned vehicles, the Agency shall provide evidence of the appropriate automobile coverage.

Insurance Services Office form number (CA 00 01 Ed. 12-90) covering **BUSINESS AUTO COVERAGE**, symbol 1 "any auto"; or the appropriate coverage provided by symbols 2, 7, 8, or 9.

4. Workers' Compensation:

Workers' Compensation coverage, as required by the Industrial Insurance Act of the State of Washington, as well as any similar coverage required for this work by applicable federal or "Other States" state law.

5. Stop Gap/Employers Liability:

Coverage shall be at least as broad as the protection provided by the Workers' Compensation policy Part 2 (Employers Liability) or, in states with monopolistic state funds, the protection provided by the "Stop Gap" endorsement to the general liability policy.

C. Minimum Limits of Insurance

The Agency shall maintain limits no less than, for:

1. General Liability: \$1,000,000 combined single limit per occurrence by bodily injury, personal injury, and property damage, and for those policies with aggregate limits, a \$2,000,000 aggregate limit.
2. Professional Liability, Errors, and Omissions: \$2,000,000 per claim and in the aggregate.
3. Automobile Liability: \$1,000,000 combined single limit per accident for bodily injury and property damage. Except if the transport of clients by Agency personnel is involved, then Risk Management shall review the appropriate amount of coverage.
4. Workers' Compensation: Statutory requirements of the state of residency.
5. Stop Gap/Employers Liability: \$1,000,000.

D. Deductibles and/or Self-insured Retentions

Any deductibles or self-insured retentions greater than \$10,000 must be declared to, and approved by, the County. The deductible and/or self-insured retention of the policies shall not apply to the Agency's liability to the County and shall be the sole responsibility of the Agency.

E. Other Insurance Provisions

The insurance policies required in this Contract are to contain, or be endorsed to contain, the following provisions:

1. Liability Policies Except Professional and Workers Compensation
 - a. The County, its officers, officials, employees, and agents are to be covered as additional insureds as respects liability arising out of activities performed by or on behalf of the Agency in connection with this Contract.
 - b. The Agency's insurance coverage shall be primary insurance as respects the County, its officers, officials, employees, and agents. Any insurance and/or self-insurance maintained by the County, its offices, officials, employees, or agents shall not contribute with the Agency's insurance or benefit the Agency in any way.
 - c. The Agency's insurance shall apply separately to each insured against whom claim is made and/or lawsuit is brought, except with respect to the limits of the insurer's liability.

2. All Policies

Coverage shall not be suspended, voided, canceled, reduced in coverage or in limits, except by the reduction of the applicable aggregate limit by claims paid, until after 45 days prior written notice has been given to the County.

F. Acceptability of Insurers

Unless otherwise approved by the County,

Insurance is to be placed with insurers with a Bests' rating of no less than A:VIII, or, if not rated with Bests, with minimum surpluses the equivalent of Bests' surplus size VIII.

Professional Liability, Errors, and Omissions insurance may be placed with insurers with a Bests' rating of B+VII. Any exception must be approved by King County.

If, at any time, the foregoing policies shall fail to meet the above minimum requirements the Agency shall, upon notice to that effect from the County, promptly obtain a new policy, and shall submit the same to the County, with appropriate certificates and endorsements, for approval.

G. Verification of Coverage

The Agency shall furnish the County certificates of insurance and endorsements required by this Contract. Such certificates and endorsements, and renewals thereof, shall be attached as exhibits to the Contract. The certificates and endorsements for each insurance policy are to be signed by a person authorized by that insurer to bind coverage on its behalf. The certificates and endorsements for each insurance policy are to be on forms approved by the County prior to the commencement of activities associated with the Contract. The County reserves the right to require complete, certified copies of all required insurance policies at any time.

H. Subcontractors

The Agency shall include all subcontractors as insureds under its policies or shall furnish separate certificates of insurance and policy endorsements from each subcontractor. Insurance coverages provided by subcontractors as evidence of compliance with the insurance requirements of this Contract shall be subject to all of the requirements stated herein.

XVI. NONDISCRIMINATION AND EQUAL EMPLOYMENT OPPORTUNITY

A. Nondiscrimination in Employment Provision of Services

During the Contract Term, neither the Agency nor any party subcontracting under the authority of this Contract shall discriminate or tolerate harassment on the basis of race, color, sex, religion, national origin, marital status, sexual orientation, age, or the presence of any sensory, mental, or physical disability in the employment or application for employment or in the administration or delivery of services or any other benefits under this Contract.

B. Equal Benefits to Employees with Domestic Partners

Pursuant to Ordinance 14823, King County's "Equal Benefits" (EB) ordinance, and related administrative rules adopted by the County Executive, as a condition of award of a contract valued at \$25,000 or more, the Contractor agrees that it shall not discriminate in the provision of employee benefits between employees with spouses, and employees with domestic partners during the performance of this Contract. Failure to comply with this provision shall be considered a material breach of this Contract, and may subject the Contractor to administrative sanctions and remedies for breach.

When the contract is valued at \$25,000 or more, the Contractor shall complete a Worksheet and Declaration form for County review and acceptance prior to Contract execution. The EB Compliance forms, Ordinance 14823 (which is codified at KCC Chapter 12.19), and related administrative rules are incorporated herein by reference. They are also available online at:
<http://www.metrokc.gov/procurement/services/eb.aspx>

C. Nondiscrimination in Subcontracting Practices

During the solicitation, award and term of this Contract, the Agency shall not create barriers to open and fair opportunities to participate in County contracts or to obtain or compete for contracts and subcontracts as sources of supplies, equipment, construction and services. In considering offers from and doing business with subcontractors and suppliers, the Agency shall not discriminate against any person on the basis of race, color, religion, sex, age, national origin, marital status, sexual orientation or the presence of any mental or physical disability in an otherwise qualified disabled person.

D. Compliance with Laws and Regulations

The Agency shall comply fully with all applicable federal, state and local laws, ordinances, executive orders and regulations that prohibit discrimination. These laws include, but are not limited to, KCC 12.17, RCW Chapter 49.60, Titles VI and VII of the Civil Rights Act of 1964, 42 U.S.C. 2000(a) et seq., the Americans with Disabilities Act, 42 U.S.C. 12101 et seq., and the Restoration Act of 1987. The Agency shall further comply fully with any affirmative action requirements set forth in any federal regulations, statutes or rules included or referenced in the Contract.

E. Small Business and Minority and Women Business Enterprise Opportunities

The County encourages the Agency to utilize small businesses, including Minority-owned and Women-owned Business Enterprises ("M/WBEs") in County contracts. The County encourages the Agency to use the following voluntary practices to promote open competitive opportunities for small businesses, including M/WBEs:

1. Attending a pre-bid or pre-solicitation conference, if scheduled by the County, to provide project information and to inform small businesses and other firms of contracting and subcontracting opportunities;
2. Placing all qualified small businesses, attempting to do business in King County, including M/WBEs, on solicitation lists; and providing written notice of subcontracting opportunities to these firms capable of performing the work, including without limitation all businesses on any list provided by the County, in sufficient time to allow such businesses to respond to the written solicitations;

3. Breaking down total requirements into smaller tasks or quantities, where economically feasible, in order to permit maximum participation by small businesses, including M/WBEs;
4. Establishing delivery schedules, where the requirements of this Contract permit, that encourage participation by small businesses, including M/WBEs;
5. Providing small businesses, including M/WBEs that express interest with adequate and timely information about plans, specifications, and requirements of the Contract;
6. Using the services of available community organizations, contractor groups, local assistance offices, the County, and other organizations that provide assistance in the recruitment and placement of small businesses, including M/WBEs; and,
7. The Washington State Office of Minority and Women's Business Enterprises (OMWBE) can provide a list of certified M/WBEs. Contact OMWBE office at 360-753-9693 or on-line through the web site at www.wsdot.wa.gov/omwbe/.

F. Equal Employment Opportunity

The Agency shall implement and carry out the obligations in its Affidavit and Certificate of Compliance regarding equal employment opportunity, and all other requirements as set forth in the Affidavit and Certificate of Compliance.

G. Fair Employment Practices

King County Code Chapter 12.18 is incorporated by reference as if fully set forth herein and such requirements apply to this Contract. During the performance of this Contract, neither the Agency nor any party subcontracting under the authority of this Contract shall engage in unfair employment practices. It is an unfair employment practice for any:

1. Employer or labor organization to discriminate against any person with respect to referral, hiring, tenure, promotion, terms, conditions, wages or other privileges of employment;
2. Employment agency or labor organization to discriminate against any person with respect to membership rights and privileges, admission to or participation in any guidance program, apprenticeship training program, or other occupational training program;
3. Employers, employment agency, or labor organization to print, circulate, or cause to be printed, published or circulated, any statement, advertisement, or publication relating to employment or membership, or to use any form of application therefore, which indicates any discrimination unless based upon a bona fide occupation qualification;
4. Employment agency to discriminate against any person with respect to any reference for employment or assignment to a particular job classification;
5. Employer, employment agency or a labor organization to retaliate against any person because that person has opposed any practice forbidden by KCC

Chapter 12.18 or because that person has made a charge, testified or assisted in any manner in any investigation, proceeding or hearing initiated under the provisions of KCC Chapter 12.18;

6. Publisher, firm, corporation, organization or association printing, publishing or circulating any newspaper, magazine or other written publication to print or cause to be printed or circulated any advertisement with knowledge that the same is in violation of KCC Chapter 12.18.030.C., or to segregate and separately designate advertisements as applying only to men or women unless such discrimination is reasonably necessary to the normal operation of the particular business, enterprise or employment, unless based upon a bona fide occupational qualification;
7. Employer to prohibit any person from speaking in a language other than English in the workplace unless:
 - a. The employer can show that requiring that employees speak English at certain times is justified by business necessity, and
 - b. The employer informs employees of the requirement and the consequences of violating the rule.
8. If the Agency engages in unfair employment practices as defined above, remedies as set forth in KCC Chapter 12.18 may be applied.

H. Record-Keeping Requirements and Site Visits

The Agency shall maintain, for at least six years after completion of all work under this Contract, the following:

1. Records of employment, employment advertisements, application forms, and other pertinent data, records and information related to employment, and solicited applications for employment; and
2. Records, including written quotes, bids, estimates or proposals submitted to the Agency by all businesses responding to Agency solicitation, and any other information necessary to document the actual use of and payments to subcontractors and suppliers in this Contract, including employment records.

The County may visit upon reasonable notice, at any reasonable time, the site of the work and the Agency's office to review the foregoing records. The Agency shall provide every assistance requested by the County during such visits. In all other respects, the Agency shall make the foregoing records available to the County for inspection and copying any reasonable volume of documents upon request. If this Contract involves federal funds, the Agency shall comply with all record keeping requirements set forth in any federal rules, regulations or statutes included or referenced in this Contract and the Exhibits attached.

I. Sanctions for Violations

Any violation of the mandatory requirements of the provisions of this Section shall be a material breach of this Contract for which the Agency may be subject to damages, withhold of payment and any other sanctions provided for by this Contract and by applicable law.

J. Reporting

1. The Agency shall submit with this Contract a total Personnel Inventory Report providing employment data for minorities, females, and persons with disabilities.

Subject to the provisions of KCC Chapter 12.16.060, the Agency's Personnel Inventory Report shall be effective for two years after the date on which the report was submitted.

2. The Agency also shall submit an Affidavit of Compliance in the form provided by the County, demonstrating commitment to comply with the provisions of KCC Chapter 12.16 in accordance with Paragraph A of this Section.

The Agency shall complete the Affidavit of Compliance provided by the County and attach the original, notarized, completed form to this Contract. Subject to the provisions of KCC Chapter 12.16.060, the Agency's Affidavit of Compliance shall be effective for two years after the date on which the report was submitted.

If the Agency engages in unfair employment practices as defined above, remedies as set forth in KCC Chapter 12.18 shall be applied as well as any other remedies by law.

The Agency shall complete all reports and forms (including Department of Social and Health Services non-discrimination forms, where applicable) provided by the County and shall otherwise cooperate fully with the County in monitoring and assisting the Agency in providing nondiscriminatory programs.

XVII. SECTION 504 AND AMERICANS WITH DISABILITIES ACT

The Agency has completed a 504/ADA Self-Evaluation Questionnaire for all programs and services offered by the Agency (including any services not subject to this Contract), and has evaluated its services, programs and employment practices for compliance with Section 504 of the Rehabilitation Act of 1973, 29 U.S.C. 701 et seq. as amended ("504") and the ADA, 42 U.S.C. 12101 et seq. The Agency has completed, attached as an Exhibit to this Contract, and incorporated herein by reference a 504/ADA Assurance of Compliance.

XVIII. SUBCONTRACTS AND PURCHASES

- A. The Agency shall include the above Sections IV, V, VI, VII, VIII, XIII, XIV, XV, XVI, and XVII, in every subcontract or purchase agreement for services which relate to the subject matter of this Contract.
- B. The Agency agrees to include the following language verbatim in every subcontract, provider agreement, or purchase agreement for services which are the subject matter of this Contract:

"[Subcontractor] shall protect, defend, indemnify, and hold harmless King County, its officers, employees and agents from any and all costs, claims, judgments, and/or awards of damages arising out of, or in any way resulting from the negligent act or omissions of subcontractor, its officers, employees, and/or agents in connection with or in support of this Contract. Subcontractor expressly agrees and understands that King

County is a third party beneficiary to this Contract and shall have the right to bring an action against subcontractor to enforce the provisions of this paragraph.”

XIX. CONFLICT OF INTEREST

- A. The Agency agrees that it will not willfully attempt to secure preferential treatment in its dealings with the County by offering any valuable consideration, thing of value or gift, whether in the form of services, loan, thing or promise, in any form to any County official or employee. The Agency acknowledges that if it is found to have violated the prohibition found in this paragraph, its current contracts with the County shall be cancelled and it shall not be able to bid on any County contract for a period of two years.
- B. The Agency acknowledges that for one year after leaving County employment, a former County employee may not have a financial or beneficial interest in a contract or grant that was planned, authorized, or funded by a County action in which the former County employee participated during County employment. Agency shall identify, at the time of offer, current or former County employees involved in the preparation of proposals or the anticipated performance of work if awarded the Contract. Failure to identify current or former County employees involved in this transaction may result in the County's denying or terminating this Contract. Before making an employment offer to a person who has less than a year separation from County employment, the Agency shall confirm with the person being offered the employment offer of their compliance with KCC Chapter 3.04 and this paragraph.
- C. Failure to comply with this Section XIX shall be a material breach of this Contract, and may result in termination of this Contract pursuant to Section XI and subject the Agency to the remedies stated therein, or otherwise available to the County at law or in equity.

XX. BOARD OF DIRECTORS

The Agency shall qualify at all times as a non-profit corporation under U.S.C., Subtitle A., Chapter 1, Subchapter F, Part 1, and Section 501(c)(3).

The Agency shall have an active, legally constituted board of directors in accordance with RCW Chapters 23B or 24 that shall be comprised of neither employees nor relatives of employees, officers or directors of the Agency, except as approved by the County under this Section. The Director may be an ex officio member of the Board of Directors. For the purposes of this Section, a relative is defined as a husband, wife, father, father-in-law, mother, mother-in-law, brother, brother-in-law, sister, sister-in-law, son-in-law, daughter-in-law, niece, nephew, grandparent, grandchild, uncle, aunt, child, child of domestic partner, and domestic partner. In addition, the relatives of a domestic partner shall be considered relatives to the same extent such relatives would be included in this Section, as if the employee and domestic partner were married. The Board of Directors shall meet regularly and fulfill all of the duties under applicable Washington State law and federal law.

The Board of Directors shall maintain a formal conflict of interest policy for Board members that complies with the applicable provisions of the Internal Revenue Code 501(c)(3) status, and addresses issues regarding gifts, financial gain, and improper use of position.

The Contract shall be reviewed and approved for Agency signature by the Agency's Board of Directors.

Each amendment to this Contract must be approved by the Agency's Board of Directors.

A. Interests of Agency Management and Agency Board:

The following shall be disallowed and shall be considered a conflict of interest without prior disclosure and approval of the County:

1. The Agency shall not employ an individual who is related to a director or assistant director of the Agency or an Agency Board member, either as an employee, contractor or through a corporation. This provision shall not apply when the total compensation paid to the individual is less than \$500 per annum.
2. The Agency shall not acquire or rent real and/or personal property owned or rented by either:
 - a. an employee or Board member of the Agency;
 - b. a relative of an employee or Board member of the Agency; or
 - c. a corporation in which an employee or Board member of the Agency, or a relative of such a person, has ownership.

B. Failure to comply with any provision of this Section XX shall constitute a material breach of this Contract.

XXI. MANAGING DIRECTOR OF AGENCY

The managing director of the Agency shall be an attorney licensed to practice law in the State of Washington. The managing director shall be a salaried employee of the Agency, subject to the authority and control of the Board of Directors of the Agency. The managing director of the Agency shall be responsible for receiving funds into program accounts or issuing financial documents, checks, or other instruments of payment for program costs provided pursuant to this Contract.

XXII. POLITICAL ACTIVITY PROHIBITED

No funds, materials, property, or services provided directly or indirectly under this Contract shall be used for any partisan political activity or to further the election or defeat of any candidate for public office.

XXIII. EQUIPMENT PURCHASE, MAINTENANCE, AND OWNERSHIP

- A. The Agency agrees that any equipment purchased with Contract funds at a cost of \$5,000 per item or more, and identified in an exhibit as reimbursable, is upon its purchase or receipt the property of the County, and/or federal, and/or state government as specified in the exhibit.
- B. The Agency shall be responsible for all such equipment, including the proper care and maintenance.
- C. The Agency shall ensure that all such equipment will be returned to the appropriate government agency, whether federal, state or County, upon written request of the County.

- D. The Agency shall admit County staff to the Agency's premises for the purpose of marking such equipment with appropriate government property tags.
- E. The Agency shall establish and maintain inventory records and transaction documents (purchase requisitions, packing slips, invoices, receipts) of equipment purchased with Contract identified funds.

XXIV. NOTICES

Whenever this Contract provides for notice to be provided by one party to another, such notice shall be:

- A. In writing; and

Directed to the managing director of the Agency, the President of the Board of Directors of the Agency, The Office of the Public Defender, and the director of the Department of Community and Human Services.

- B. Any due date within which a party must take some action shall be computed according to CR 6(a). If notice is provided by US Post, CR 5(b)(2)(A) shall apply to determine the date of service.

XXV. PROPRIETARY RIGHTS

The parties to this Contract hereby mutually agree that if any patentable or copyrightable material or article is the product of work performed for the County as described herein, all rights accruing from such material or article shall be the sole property of the Agency. The Agency agrees to and does hereby grant to the County, irrevocable, nonexclusive, and royalty-free license to use, according to law, any material or article and use any method that may be developed as part of the work under this Contract.

The foregoing products license shall not apply to existing training materials, consulting aids, checklists, and other materials and documents of the Agency which are used in the performance of this Contract.

XXVI. CONTRACT AMENDMENTS

Either party may request changes to this Contract. Proposed changes which are mutually agreed upon shall be incorporated by written amendments to this Contract.

XXVII. KING COUNTY RECYCLED PRODUCT PROCUREMENT POLICY

The Agency shall use recycled paper for the production of all printed and photocopied documents related to the fulfillment of this Contract and shall ensure that, whenever possible, the cover page of each document printed on recycled paper bears an imprint identifying it as recycled paper. All Court document production shall be covered by Court rules.

If the cost of recycled paper is more than 15 percent higher than the cost of non-recycled paper, the Agency may notify the Contract Administrator, who may waive the recycled paper requirement.

The Agency shall use both sides of paper sheets for copying and printing and shall use recycled/recyclable products wherever practical in the fulfillment of this Contract.

XXVIII. SERVICES PROVIDED IN ACCORDANCE WITH LAW AND RULE AND REGULATION

The Agency and any subcontractor agree to abide by all of the laws of the State of Washington that are applicable to their business and the substance of the legal services that are the subject of this Contract. The Agency and any subcontractors also agree to abide by all Rules of Professional Conduct governing attorney conduct and to abide by the requirements of the attorney-client privilege, as defined by Washington statutory law and common law.

In the event that there is a conflict between any of the language contained in any exhibit or attachment to this Contract, the language in the Contract shall have control over the language contained in the exhibit or the attachment, unless the parties affirmatively agree in writing to the contrary.

XXIX. CONFIDENTIALITY

The Agency agrees that information, records, and data collected in connection with this Contract shall be protected from unauthorized disclosure in accordance with applicable common law, state and federal law, including but not limited to attorney-client privilege. The County agrees that the King County Office of The Public Defender shall protect any information received from the Agency from unauthorized disclosure in accordance with applicable common law, state and federal law, including but not limited to attorney-client privilege.

The County, through the Office of The Public Defender, shall abide by any applicable law of privilege in monitoring the Agency's performance under this Contract.

XXX. COMPLIANCE WITH THE HEALTH INSURANCE PORTABILITY ACCOUNTABILITY ACT OF 1996

Terms used in this Section shall have the same meaning as those terms in the Privacy Rule, 45 CFR Parts 160 and 164.

A. Obligations and Activities of the Agency

1. The Agency agrees not to acquire, use, or disclose protected health information other than as permitted or required by law.
2. The Agency agrees to implement administrative, physical, and technical safeguards that reasonably and appropriately protect the confidentiality, integrity, and availability of the protected health information that it creates, receives, maintains, or transmits on behalf of the County as required by CFR Title 45, Section 164, Subpart C.
3. The Agency agrees to mitigate, to the extent practicable, any harmful effect that is known to the Agency of a use or disclosure of protected health information by the Agency in violation of the requirements of this Contract.
4. The Agency agrees to report in writing all unauthorized or otherwise improper disclosures of a client's protected health information or security incident to the County by the Agency within two days of the Agency knowledge of such event.
5. The Agency agrees to ensure that any agent, including a subcontractor, to whom it provides protected health information received from, or created or received by the Agency on behalf of the County, agrees to the same restrictions

and conditions that apply through this Contract to the Agency with respect to such information.

6. The Agency agrees to make available protected health information in accordance with 45 CFR § 164.524.
7. The Agency agrees to make available protected health information for amendment and incorporate any amendments to protected health information in accordance with 45 CFR § 164.526.
8. The Agency agrees to make internal practices, books, and records, including policies and procedures and protected health information, relating to the use and disclosure of protected health information received from, or created or received by the Agency on behalf of King County, available to the Secretary, in a reasonable time and manner for purposes of the Secretary determining King County's compliance with the Privacy Rule.
9. The Agency agrees to make available the information required to provide an accounting of disclosures in accordance with 45 CFR § 164.528.

B. Permitted Uses and Disclosures by Business Associate

The Agency may use or disclose protected health information to perform functions, activities, or services for, or on behalf of, King County as specified in this Contract, provided that such use or disclosure would not violate the Privacy Rule if done by King County or the minimum necessary policies and procedures of King County.

C. Effect of Termination

1. Except as provided in Paragraph C.2. of this Section, upon termination of this Contract, for any reason, the Agency shall return or destroy all protected health information received from King County, or created or received by the Agency on behalf of King County. This provision shall apply to protected health information that is in the possession of subcontractors or agents of the Agency. The Agency shall retain no copies of the protected health information.
2. In the event the Agency determines that returning or destroying the protected health information is infeasible, the Agency shall provide to King County notification of the conditions that make return or destruction infeasible. Upon notification that return or destruction of protected health information is infeasible, the Agency shall extend the protections of the Contract to such protected health information and limit further uses and disclosure of such protected health information to those purposes that make the return or destruction infeasible, for so long as the Agency maintains such protected health information.

XXXI. NO THIRD PARTY BENEFICIARIES

Except for the Parties to whom this Contract is assigned in compliance with the terms of this Contract, there are no third party beneficiaries to this Contract, and this Contract shall not impart any rights enforceable by any person or entity that is not a Party hereto.

XXXII. ENTIRE CONTRACT/WAIVER OF DEFAULT

The parties agree that this Contract is the complete understanding of the terms hereto and any oral or written representations or understandings not incorporated herein are excluded. Both parties recognize that time is of the essence in the performance of the provisions of this Contract. Waiver of any default shall not be deemed to be a waiver of any other or subsequent breach and shall not be construed to be a modification of the terms of the Contract unless stated to be such through written approval by the County, a copy of which shall be attached to the original copy of this Contract.

XXXIII. GOVERNING LAW/SEVERABILITY/CONSTRUCTION

This Contract shall be governed by Washington law. If any one or more provisions of this Contract shall be held by any court to be invalid or unenforceable, such invalidity or unenforceability shall not adversely affect the validity or enforceability of any other part of this Contract. This Contract shall not be construed for nor against any party, regardless of its drafter.

KING COUNTY

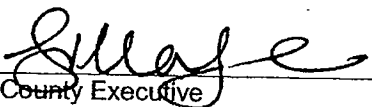
 FOR
King County Executive

Date 12/27/07

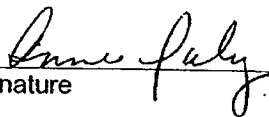
Signature

ANNE DALY
NAME (Please type or print)

12/20/07
Date

Approved as to Form:

OFFICE OF THE KING COUNTY
SPECIAL DEPUTY PROSECUTOR

Date: 11/29/07

EXHIBIT I

Certificate of Insurance/Endorsements

ACORD CERTIFICATE OF LIABILITY INSURANCE		OP ID RW S0C5000	DATE (MM/DD/YYYY) 08/16/07
PRODUCER Degginger McIntosh & Assoc. PO Box 1400 3977 Harbour Pointe SW Mukilteo WA 98275 Phone: 425-740-5200 Fax: 425-740-5201		THIS CERTIFICATE IS ISSUED AS A MATTER OF INFORMATION ONLY AND CONFERS NO RIGHTS UPON THE CERTIFICATE HOLDER. THIS CERTIFICATE DOES NOT AMEND, EXTEND OR ALTER THE COVERAGE AFFORDED BY THE POLICIES BELOW.	
INSURED Society of Counsel Representing Accused Persons 1401 E Jefferson Street, Ste 200 Seattle WA 98122-5570		INSURERS AFFORDING COVERAGE INSURER A: American Economy Insurance Co. INSURER B: Columbia Casualty Company INSURER C: INSURER D: INSURER E:	NAIC # 19690

COVERAGES

THE POLICIES OF INSURANCE LISTED BELOW HAVE BEEN ISSUED TO THE INSURED NAMED ABOVE FOR THE POLICY PERIOD INDICATED. NOTWITHSTANDING ANY REQUIREMENT, TERM OR CONDITION OF ANY CONTRACT OR OTHER DOCUMENT WITH RESPECT TO WHICH THIS CERTIFICATE MAY BE ISSUED OR MAY PERTAIN, THE INSURANCE AFFORDED BY THE POLICIES DESCRIBED HEREIN IS SUBJECT TO ALL THE TERMS, EXCLUSIONS AND CONDITIONS OF SUCH POLICIES. AGGREGATE LIMITS SHOWN MAY HAVE BEEN REDUCED BY PAID CLAIMS.

INSR ADD'L LTR INSRD	TYPE OF INSURANCE	POLICY NUMBER	POLICY EFFECTIVE DATE (MM/DD/YY)	POLICY EXPIRATION DATE (MM/DD/YY)	LIMITS
A	GENERAL LIABILITY <input checked="" type="checkbox"/> COMMERCIAL GENERAL LIABILITY <input type="checkbox"/> CLAIMS MADE <input checked="" type="checkbox"/> OCCUR GEN'L AGGREGATE LIMIT APPLIES PER: <input checked="" type="checkbox"/> POLICY <input type="checkbox"/> PRO-JECT <input type="checkbox"/> LOC	02BP19742930	06/07/07	06/07/08	EACH OCCURRENCE \$ 2,000,000
	DAMAGE TO RENTED PREMISES (Ea occurrence) \$ 100,000 MED EXP (Any one person) \$ 10,000 PERSONAL & ADV INJURY \$ 2,000,000 GENERAL AGGREGATE \$ 4,000,000 PRODUCTS - COMP/OP AGG \$ 4,000,000				
A A	AUTOMOBILE LIABILITY <input type="checkbox"/> ANY AUTO <input type="checkbox"/> ALL OWNED AUTOS <input type="checkbox"/> SCHEDULED AUTOS <input checked="" type="checkbox"/> HIRED AUTOS <input checked="" type="checkbox"/> NON-OWNED AUTOS	02BP19742930 02BP19742930	06/07/07 06/07/07	06/07/08 06/07/08	COMBINED SINGLE LIMIT (Ea accident) \$ 2,000,000 BODILY INJURY (Per person) \$ BODILY INJURY (Per accident) \$ PROPERTY DAMAGE (Per accident) \$
	GARAGE LIABILITY <input type="checkbox"/> ANY AUTO				AUTO ONLY - EA ACCIDENT \$ OTHER THAN AUTO ONLY: EA ACC \$ AGG \$
	EXCESS/UMBRELLA LIABILITY <input type="checkbox"/> OCCUR <input type="checkbox"/> CLAIMS MADE DEDUCTIBLE RETENTION \$				EACH OCCURRENCE \$ AGGREGATE \$ \$ \$ \$
A	WORKERS COMPENSATION AND EMPLOYERS' LIABILITY ANY PROPRIETOR/PARTNER/EXECUTIVE OFFICER/MEMBER EXCLUDED? If yes, describe under SPECIAL PROVISIONS below	02BP19742930 WA STOP GAP	06/07/07	06/07/08	<input type="checkbox"/> WC STATU-TORY LIMITS <input checked="" type="checkbox"/> OTH-ER E.L. EACH ACCIDENT \$ 2,000,000 E.L. DISEASE - EA EMPLOYEE \$ 2,000,000 E.L. DISEASE - POLICY LIMIT \$ 4,000,000
B	OTHER Lawyers Prof Liab	NLA169946773	08/17/07	08/17/08	Agg Limit \$ 2,000,000 Deduct \$ 1,000

DESCRIPTION OF OPERATIONS / LOCATIONS / VEHICLES / EXCLUSIONS ADDED BY ENDORSEMENT / SPECIAL PROVISIONS
 Certificate is Evidence of Insurance only.

CERTIFICATE HOLDER

CANCELLATION

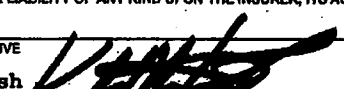
KING008 King County, Office of the Public Defender Walthew Bldg. 123 3rd Avenue S, Floor 4 Seattle WA 98104-2696	SHOULD ANY OF THE ABOVE DESCRIBED POLICIES BE CANCELLED BEFORE THE EXPIRATION DATE THEREOF, THE ISSUING INSURER WILL ENDEAVOR TO MAIL 30 DAYS WRITTEN NOTICE TO THE CERTIFICATE HOLDER NAMED TO THE LEFT, BUT FAILURE TO DO SO SHALL IMPOSE NO OBLIGATION OR LIABILITY OF ANY KIND UPON THE INSURER, ITS AGENTS OR REPRESENTATIVES. AUTHORIZED REPRESENTATIVE Kenneth McIntosh 
--	--

ACORD 25 (2001/08)

© ACORD CORPORATION 1988



King County

EXHIBIT II

Personnel Inventory Report

Legal name of business Society of Counsel Representing Accused Persons Contract No: _____
 dba (if applicable) _____ Telephone No: _____
 Street address 1401 E. Jefferson St. Ste 200 City Seattle State WA Zip Code 98122
 Submitted by: _____ Title HR Manager Date _____

Do you have any employees? No ___ Yes Sole Owner/Operator No Yes ___

If yes, list on the Employment Data Chart below the total number of employees for all businesses located within each location listed below. Indicate which locale (1,2,3) report covers. This report is for Payroll Period ending (Month/Day/Year): 12/21/07 and covers the following locale: (Check only one box)

- 1. Business located within King County
- 2. ___ Businesses located within WA State
- 3. ___ Business located with U. S.
- 4. ___ Other (specify) _____

Do any of your employees belong to a union and/or do you use an employee referral agency? No Yes ___

If yes, list the unions and/or employee referral agencies with whom you have agreements: _____ If you expect to do more than \$10,000 worth of public work (construction) or, more than \$25,000 worth of business with King County, the unions or employee referral agencies must submit a statement of compliance with King County Code Chapter 12.16.

Job Categories	Whites		African Americans		Asians		Native Americans		Hispanics		Disabled		Minority Subtotal		Disabled Subtotal	
	M	F	M	F	M	F	M	F	M	F	M	F	M	F	M	F
Managerial	2	6	1	1									1	1		
Professional	25	30	1	2	1	5			2	1		2	4	8		2
Technical																
Clerical		9		2	1	1		2		2					1	7
Sales																
Service																
Labor																
On-Job Trainees																
Apprentice																
Skilled Craft Total*																
Total																

* Journey worker: List by classification on reverse, e.g., carpenter, plumber, etc.

Total number of employees reported above: 94 If no employees, write "0."

EXHIBIT III

Affidavit and Certificate of Compliance

with King County Code Chapter 12.16, Discrimination and Affirmative Action in Employment by Contractors, Subcontractors and Vendors



The undersigned, being first duly sworn, on oath states, s/he is authorized by the Contractor, and on the Contractor's behalf, affirms and certifies as follows:

Definitions: "Contractor" shall mean any contractor, vendor or consultant who supplies goods and/or services. "Contract" shall mean any contract, purchase order or agreement with King County Government, hereinafter called the County.

- A. Contractor recognizes that discrimination in employment is prohibited by federal, state and local laws. Contractor recognizes that in addition to refraining from discrimination, affirmative action is required to provide equal employment opportunity. Contractor further recognizes that this Affidavit establishes minimum requirements for affirmative action and fair employment practices and implements the basic nondiscrimination provisions of the general contract specifications as applied to service, consultant, and vendor contracts exceeding \$25,000, or public work contracts exceeding \$10,000. Contractor herein agrees that this Affidavit is incorporated as an addendum to its general contract, and recognizes that failure to comply with these requirements may constitute grounds for application of sanctions as set forth in the general specifications, King County Code Chapter 12.16 ("Chapter") and this Affidavit. PROVIDED FURTHER, that in lieu of this Affidavit, the Executive may accept a statement pledging adherence to an existing contractor affirmative action plan where the provisions of the plan are found by the Executive to substantially fulfill the requirements of the Chapter.
- B. Contractor shall give notice to their supervisors and employees of the requirements for affirmative action to be undertaken prior to the commencement of work.
- C. This person has been designated to represent the Contractor and to be responsible for securing compliance with and for reporting on the affirmative actions taken:
- D. Contractor will cooperate fully with the BD and Contract Compliance Section and appropriate County agents while making every reasonable "good faith" effort to comply with the affirmative action and nondiscrimination requirements set forth in this Affidavit and in King County Code Chapter 12.16.
- E. **Reports:** The Contractor agrees to complete and submit as required such additional reports and records that may be necessary to determine compliance with the Affidavit and to confer with the County Compliance Officer at such times as the County shall deem necessary. The information required by the Chapter includes but is not limited to the following reports and records:
 1. **Personnel Inventory Report:** This report shall include a breakdown of the employer workforce showing race, sex and handicapped and other minority data.
 2. **Monthly EEO Report:** This report shall apply to construction contractors and subcontractors and shall provide the number of hours of employment for all employees, including minority, women and disabled employees by craft and category.
 3. **Statement from Union or Worker Referral Agency:** This statement affirms that the signer's organization has no practices and policies which discriminate on the basis of race,

color, creed, religion, sex, age, marital status, sexual orientation, nationality or the presence of sensory, mental or physical disability.

The information required in this section shall be submitted on forms provided by the County unless otherwise specified.

- F. **Subcontractors:** For public works projects and contracts over ten thousand dollars (\$10,000) the prime contractor shall be required to submit to the County, along with its qualifying documents under the Chapter, employment profiles, Affidavits and Certificates of Compliance, Reports and Union Statements from its subcontractors in the same manner as these are required of the prime contractor. Reporting requirements of the prime contractor during the contract period will apply equally to all subcontractors.
- G. **Employment Goals for Minorities, Women and Persons with Disabilities:** No specific levels of utilization of minorities and women in the workforce of the Contractor shall be required, and the Contractor is not required to grant any preferential treatment on the basis of race, sex, color, ethnicity or national origin in its employment practices. Notwithstanding the foregoing, any affirmative action requirements set forth in any federal regulations, statutes or rules included or referenced in the contract documents shall continue to apply.
- H. **Affirmative Action Measures:** Contractor agrees to implement and/or maintain reasonable good faith efforts to comply with King County Code Chapter 12.16. The evaluation of a contractor's compliance with the Chapter shall be based upon the contractor's effort to achieve maximum results from its affirmative action measures. The Contractor shall document these efforts and shall implement affirmative action steps at least as extensive as the following:
 1. **Policy Dissemination:** Internal and external dissemination of the contractor's equal employment opportunity policy; posting of nondiscrimination policies and of the requirement of the Chapter on bulletin boards clearly visible to all employees; notification to each subcontractor, labor union or representative of workers with which there is a collective bargaining agreement or other contract, subcontract, or understanding of the contractor's commitments under the Chapter. Inclusion of the equal opportunity policy in advertising in the news media and elsewhere.
 2. **Recruiting:** Adopt and implement recruitment procedures designed to increase the representation of women, minorities and persons with disabilities in the pool of applicants for employment; including, but not limited to establishing and maintaining a current list of minority, women and disabled recruitment sources, providing these sources written notification of employment opportunities and advertising vacant positions in newspapers and periodicals which have minority, women and/or disabled readership.
 3. **Self-Assessment and Test Validation:** Review of all employment policies and procedures, including tests, recruitment, hiring and training practices and policies, performance evaluations, seniority policies and practices, job classifications and job assignments to assure that they do not discriminate against, or have a discriminatory impact on, minorities, women and persons with disabilities and validate all tests and

other selection requirements where there is an obligation to do so under state or federal law.

- 4. **Record Referrals:** Maintain a current file of applications of each minority, women and persons with disabilities who are applicants or referrals for employment indicating what action was taken with respect to each such individual and the reasons therefor. Contact these people when an opening exists for which they may be qualified. Names may be removed from the file after twelve months have elapsed from their last application or referral.
- 5. **Notice to Unions:** Provide notice to labor unions of the contractor's nondiscrimination and affirmative action obligations pursuant to King County Code Chapter 12.16. Contractors shall also notify the BD and Contract Compliance Section if labor unions fail to comply with the nondiscrimination or affirmative provisions
- 6. **Supervisors:** Ensure that all supervisory personnel understand and are directed to adhere to and implement the non-discrimination and affirmative action obligations of the contractor under King County Code Chapter 12.16. Such direction shall include, but not be limited to, adherence to, and achievement of, affirmative action policies in performance appraisals of supervisory personnel.
- 7. **Employee Training:** When reasonable, develop on-the-job training opportunities which expressly include minorities, women, and persons with disabilities and sponsor and/or utilize, training/educational opportunities for the advancement of women, minorities and persons with disabilities employed by the contractor, subject to acceptance by the county.
- 8. **Responsible Person:** Designate an employee who shall have the responsibility for implementation of the Contractor's affirmative action measures.
- 9. **Progress Reporting:** Prepare as part of the affirmative action plan an analysis and report on the progress made toward eliminating the underrepresentation of minorities, women, and persons with disabilities in the contractor's workforce on

an annual basis.

- I. During the performance of this Contract, neither the Contractor nor any party subcontracting under the authority of this Contract shall discriminate nor tolerate harassment on the basis of race, color, sex, religion, nationality, creed, marital status, sexual orientation, age, or the presence of any sensory, mental or physical disability in the employment or application for employment or in the administration or delivery of services or any other benefits under this Contract.
- J. Contractor agrees to provide reasonable access upon request to the premises of all places of business and employment, relative to work undertaken in this Contract, and to records, files, information and employees in connection therewith, to the BD and Contract Compliance Section or agent for purposes of reviewing compliance with the provisions of this Affidavit and agrees to cooperate in any compliance review.
- K. Should the BD and Contract Compliance Section find, upon complaint investigation or review, the Contractor not to be in good faith compliance with the provisions contained in this Affidavit, it shall notify the County and Contractor in writing of the finding fully describing the basis of non-compliance. Contractor may request withdrawal of such notice of noncompliance at such time as the compliance office has notified in writing the Contractor and the County that the noncompliance has been resolved.
- L. The Contractor agrees that any violation of any term of this Affidavit, including reporting requirements, shall be deemed a violation of King County Code Chapter 12.16. Any such violation shall be further deemed a breach of a material provision of the Contract between the County and the Contractor. Such breach may be grounds for implementation of any sanctions provided for in the Chapter, including but not limited to, cancellation, termination or suspension, in whole or part, of the Contractor by the County; liquidated damages; or disqualification of the Contractor. PROVIDED, that the implementation of any sanctions is subject to the notice and hearing provisions of King County Code Chapter 12.16.110.

Contractor: Society of Counsel 1401 E. Jefferson St. Ste 200 Seattle WA 98102
Company Name Street Address City State Zip

I have read and understood the foregoing; and am authorized on behalf of the Contractor to agree to the terms and conditions of this and Affidavit and Certificate of Compliance and therefore, execute the same.

Authorized Signer: [Signature] Henry 2063228710 [Signature]
Name (type or print) Title Phone Signature

VALID ONLY IF NOTARIZED

SUBSCRIBED AND SWORN TO BEFOR ME THIS 21 DAY OF December, 2007

[Signature]
 Notary Public in and of the state of Washington
 Residing at: Seattle



EXHIBIT IV

504/ADA SELF-EVALUATION AND ASSURANCE OF COMPLIANCE

Instructions

504/ADA Self-Evaluation Questionnaire Form

This form will help you evaluate your organization's or firm's programs and services, employment, and facilities to ensure they are accessible to people with disabilities. Complete the 504/ADA Self-Evaluation Questionnaire and keep it on file at your office. Do not return the questionnaire with your contract.

"Quick Look" Barriers Checklist

Note: If the business is a construction company, this form pertains only to the main office, not the construction sites. Firms that provide services outside their office do not need to write a corrective action plan for physical accessibility as long as these services are provided in an accessible location for people with disabilities who cannot access the office. However, physical access must also be reviewed in light of hiring an individual with a disability or accommodating a current employee who becomes disabled.

504/ADA Assurance of Compliance Form

All contractors must complete this form, as required by King County Code 12.16.060. Governmental agencies and contracts for the direct purchase of goods are exempt.

- **Complete this form.** If your organization or firm is out of compliance with any of the 504/ADA requirements, indicate on the 504/ADA Disability Assurance of Compliance form the corrective actions that will be taken to achieve compliance and the date these actions will be completed.
- **Sign the Assurance of Compliance form and send the original back with your contract.** Keep a copy of the form on file in your office for use during on-site reviews. You will be notified at least one week in advance of any scheduled review. (Note: This form may be used as an exhibit with other King County contracts for two years from the date the form is completed.)

If you have questions regarding this process, or if you require this material in an alternate format, please contact a King County 504/ADA Disability Compliance Specialist at 206-296-7592 or 206-296-7596 TTY, or by e-mail: Civil-Rights.OCR@kingcounty.gov.

504/ADA General Information

Federal and State laws prohibit discrimination based on disability. Section 504 of the Rehabilitation Act of 1973, as amended (504), and the Americans with Disabilities Act of 1990 (ADA) require that King County and all organizations and firms contracting with King County, except those providing tangible goods, comply with the 504/ADA accessibility requirements.

Under 504 and ADA, a "qualified individual with a disability" is anyone who has, has a history of, or is perceived as having a physical or mental impairment which substantially limits one or more major life activities. Disabilities include, but are not limited to: mobility, visual, hearing, or speech disabilities; mental illness; epilepsy; learning disability; brain injury; HIV/AIDS; arthritis; cerebral palsy; multiple sclerosis; developmental disability; and alcohol and/or drug addiction.

DISABILITY RESOURCE LIST

Note: Inclusion in this resource list does not constitute endorsement by King County Government, nor does omission imply non-endorsement. Our goal is to provide you with information on some key resources available. Please contact us if you know of a useful resource missing from this list.

King County Office of Civil Rights

Disability Compliance Specialist, Yesler Building, 400 Yesler Way, Room 260, Seattle, WA 98104-2683; 206-296-7592 V, 206-296-7596 TTY; 206-296-4329 Fax; e-mail: Civil-Rights.OCR@kingcounty.gov
web site: www.metrokc.gov/dias/ocre

Governor's Committee on Disability Issues and Employment (GCDE)

Advises and informs the Governor, state and local governments, the business community, and the disability community on ADA and other issues related to disability policy.
Olympia: 360-438-3168 V, 360-438-3167 TTY; Spokane: 509-532-3149 V, 509-532-3113 TTY.

GCDE publishes "Producing Materials in Alternative Formats: A Guide for Agencies"

which provides information on producing materials in large print, on audio tape or computer disk, and Braille. Send a written request for a copy.

DBTAC Northwest

Provides information on the Americans with Disabilities Act in Alaska, Idaho, Oregon and Washington. Western Washington University 6912 220th St. SW, Suite 105 Mountlake Terrace, WA 98043
800-949-4232 V/TTY
425-774-9303 Fax
e-mail: dbtacnw@wwu.edu
web site: www.dbtacnorthwest.org

Sprint Washington Telecommunications Relay Service (TRS)

Provides free telephone accessibility with TTY users. 500 108th Avenue NE, Suite 800, Bellevue, WA 98004; Relay Services: 711 TTY; 800-833-6384 V.

ADA Technical Assistance Hotline (U.S. Dept. of Justice)

Provides free technical assistance and informational materials to people with disabilities, businesses, state and local government agencies, and the general public on rights and responsibilities under Titles II and III of the ADA. 800-514-0301 V/TTY.
web site: www.usdoj.gov/crt/ada

Washington Assistive Technology Alliance (WATA)

Information & referral to disability resources, including assistive technology options, funding sources, legal issues, accommodations. 509-328-9350 V/TTY; 800-214-8731 V/TTY; 509-326-2261 Fax; e-mail: spokane@seals.org
web site: wata.org/wata/eatrc/index.htm

Job Accommodations Network (JAN)

An international toll-free consulting service that provides information regarding the ADA, job accommodations and the employability of people with disabilities. P.O. Box 6080, 918 Chestnut Ridge Road, Suite 1, Morgantown, WV 26506-6080;
JAN ADA Information 800-526-7234 V/TTY; 800-ADA-WORK (232-9675) V/TTY;
web site: janweb.icdi.wvu.edu

Emergency Procedures for Employees with Disabilities in Office Occupancies

A procedural guideline funded by the U.S. Fire Administration and developed by the National Institute of Standards and Technology with assistance from the National Task Force on Life Safety and People with Disabilities. Write for a copy of Item Number FA -154: United States Fire Administration, 16825 South Seton Avenue, Emmitsburg, MD 21727.

504/ADA SELF-EVALUATION QUESTIONNAIRE

General Requirements

Please check the appropriate answers. If necessary, attach additional pages of explanation. If you have fewer than 15 employees, please skip the first section and start with "Program Access."

- | | YES | NO | N/A |
|---|-------------------------------------|--------------------------|--------------------------|
| 1. Do you have a 504/ADA coordinator? If so, who? | <input checked="" type="checkbox"/> | <input type="checkbox"/> | <input type="checkbox"/> |
| Name <u>Lynna L. Exe</u> | | | |
| Title <u>HR Manager</u> Phone <u>206-322-8400</u> | | | |
| 2. Do you have an internal grievance procedure that allows for quick and prompt solutions for any complaints based on alleged noncompliance with 504/ADA? | <input checked="" type="checkbox"/> | <input type="checkbox"/> | <input type="checkbox"/> |
| 3. Do you have a policy that provides for notifying participants, applicants, employees, unions, and professional organizations holding collective bargaining or professional agreements that you do not discriminate on the basis of disability? | <input checked="" type="checkbox"/> | <input type="checkbox"/> | <input type="checkbox"/> |
| 4. Have you notified these individuals of your nondiscrimination policy? | <input checked="" type="checkbox"/> | <input type="checkbox"/> | <input type="checkbox"/> |
| 5. Do you provide ongoing staff training to ensure that staff fully understand your policy of nondiscrimination on the basis of disability and can take all appropriate steps to facilitate the participation of individuals with disabilities in agency programs and activities? | <input checked="" type="checkbox"/> | <input type="checkbox"/> | <input type="checkbox"/> |

Program Access

- | | | | |
|---|-------------------------------------|--------------------------|-------------------------------------|
| 1. Do you notify the public and other interested parties that agency meetings, board of director meetings, hearings, conferences, public appearances by elected officials, and interviews will be held in accessible locations? | <input checked="" type="checkbox"/> | <input type="checkbox"/> | <input type="checkbox"/> |
| 2. Do you notify the public and other interested parties that auxiliary aids (sign language interpreters, readers) will be provided, upon request, to participants with disabilities? | <input type="checkbox"/> | <input type="checkbox"/> | <input checked="" type="checkbox"/> |
| 3. Do you have a Teletypewriter (TTY), or do you use the statewide Telecommunications Relay Service to facilitate communication with individuals who use TTYs for communication purposes? | <input type="checkbox"/> | <input type="checkbox"/> | <input checked="" type="checkbox"/> |
| 4. Do you provide ongoing training to familiarize appropriate staff with the operation of the TTY (or Relay Service) and other effective means of communicating over the telephone with people with disabilities? | <input type="checkbox"/> | <input type="checkbox"/> | <input checked="" type="checkbox"/> |

Program Access (continued)

- | | YES | NO | N/A |
|--|-------------------------------------|-------------------------------------|-------------------------------------|
| 5. Do you make available, upon request, written material in alternate formats for people who have disabilities? (Alternate formats include large print, Braille, and audiocassette tapes) | <input type="checkbox"/> | <input type="checkbox"/> | <input checked="" type="checkbox"/> |
| 6. Are printed posters, announcements, and printed materials (including graphics) clearly legible and placed in physically accessible locations where print can be read from a wheelchair? | <input checked="" type="checkbox"/> | <input type="checkbox"/> | <input type="checkbox"/> |
| 7. If you have a mailing list for the purposes of information dissemination, does it include various disability groups? | <input type="checkbox"/> | <input checked="" type="checkbox"/> | <input type="checkbox"/> |
| 8. Are your TTY number and procedures for accessing your services printed on all material distributed to the public? | <input type="checkbox"/> | <input type="checkbox"/> | <input checked="" type="checkbox"/> |
| 9. Do you have a policy and procedure for safe emergency evacuation of people with disabilities from your facility(s)? | <input checked="" type="checkbox"/> | <input type="checkbox"/> | <input type="checkbox"/> |

Employment and Reasonable Accommodation

- | | | | |
|--|-------------------------------------|--------------------------|-------------------------------------|
| 1. When gathering affirmative action data regarding disabilities, do you make it clear that: | | | |
| • the information requested is intended for use solely in connection with reporting requirements; | | | |
| • the information is voluntary; | | | |
| • the information will be kept confidential; and | | | |
| • refusal to provide or providing the information will not subject the applicant or employee to any adverse treatment? | <input checked="" type="checkbox"/> | <input type="checkbox"/> | <input type="checkbox"/> |
| 2. If you make pre-employment medical inquiries or conduct pre-employment medical examinations: | | | |
| • Is the inquiry related to the applicant's ability to perform the job? | <input type="checkbox"/> | <input type="checkbox"/> | <input checked="" type="checkbox"/> |
| • Do you condition offers of employment on the results of these examinations? | <input type="checkbox"/> | <input type="checkbox"/> | <input checked="" type="checkbox"/> |
| • Is the examination required for <u>all</u> employees in the same job classification? | <input type="checkbox"/> | <input type="checkbox"/> | <input checked="" type="checkbox"/> |
| • Are <u>all</u> applicants in the same job classification asked the same medical and/or interview questions? | <input type="checkbox"/> | <input type="checkbox"/> | <input checked="" type="checkbox"/> |
| 3. During the application, interviewing, hiring, and employment process, do you provide reasonable accommodations to applicants and employees with disabilities? | <input checked="" type="checkbox"/> | <input type="checkbox"/> | <input type="checkbox"/> |

Employment and Reasonable Accommodation (continued)

YES NO N/A

4. Do you have a written policy stating the following?

504/ADA requires that information concerning an applicant's medical condition or history must be kept separate from personnel records and may be shared in only three ways:

- (1) supervisors and managers may be informed of restrictions on the work or duties of individuals with disabilities and informed of necessary accommodation(s);
- (2) first aid and safety personnel may be informed if the condition might require emergency treatment; and
- (3) government officials investigating compliance with 504/ADA shall be provided with relevant information upon request.

Physical Accessibility

Complete the "Quick Look" Barriers Checklist and then answer the following questions:

1. Is the building(s) where your business is located barrier-free?

2. If you checked NO to any of the items on the Employment and Reasonable Accommodation checklist above, would these areas prevent an individual with a disability from accessing your program(s) or service(s)?

If access would be impacted, describe on the Corrective Action Plan what steps will be taken to eliminate the barrier(s). If there are extenuating circumstances which would make barrier removal a financial or administrative burden, please explain in the Corrective Action Plan.

This 504/ADA Self-Evaluation Questionnaire was completed by:

Lynna L. Foxe
Print name

12/21/07
Date

206 322 8400
Phone Number

"QUICK LOOK" BARRIERS CHECKLIST

This checklist may be used to conduct a quick appraisal of potential problem areas for accessibility. For detailed review standards, refer to IBC 2003, ANSI A117.1-2003, and the Washington State Administrative Code (WAC) 51-50. If you are not located in State of Washington, you may refer to federal ADA Accessibility Guidelines (ADAAG), state or local laws and regulations.

Building Access

	YES	NO	N/A
• Garage/lot has required number of accessible parking spaces?	<input checked="" type="checkbox"/>	<input type="checkbox"/>	<input type="checkbox"/>
• Are accessible parking spaces near main building entrance?	<input checked="" type="checkbox"/>	<input type="checkbox"/>	<input type="checkbox"/>
• Walkways are level (44" wide min.) or ramped (max. 1:12)?	<input checked="" type="checkbox"/>	<input type="checkbox"/>	<input type="checkbox"/>
• Does the entrance doorway have at least 32" wide clearance?	<input checked="" type="checkbox"/>	<input type="checkbox"/>	<input type="checkbox"/>
• Is the door threshold maximum 1/4" high (1/2" if beveled)?	<input checked="" type="checkbox"/>	<input type="checkbox"/>	<input type="checkbox"/>
• Door hardware is lever handles, pulls, or push-pull activating bars?	<input checked="" type="checkbox"/>	<input type="checkbox"/>	<input type="checkbox"/>
• Are the doors easy to open (exterior doors max. 8.5 lbs. opening force, interior doors 5 lbs. max.)?	<input checked="" type="checkbox"/>	<input type="checkbox"/>	<input type="checkbox"/>
• If revolving doors used, alternate accessible entrance available?	<input type="checkbox"/>	<input type="checkbox"/>	<input checked="" type="checkbox"/>

Building Corridors

• Is path of travel free of obstruction and at least 36" wide?	<input checked="" type="checkbox"/>	<input type="checkbox"/>	<input type="checkbox"/>
• Is floor surface stable, firm and slip resistant?	<input checked="" type="checkbox"/>	<input type="checkbox"/>	<input type="checkbox"/>
• Do obstacles (phones, fountains, etc.) protrude no more than 4"?	<input type="checkbox"/>	<input type="checkbox"/>	<input checked="" type="checkbox"/>
• If provided, minimum one public phone or water fountain accessible?	<input type="checkbox"/>	<input type="checkbox"/>	<input checked="" type="checkbox"/>
• Are elevator controls no higher than 48"?	<input checked="" type="checkbox"/>	<input type="checkbox"/>	<input type="checkbox"/>
• Are elevator markings in Braille and raised letters/numbers?	<input checked="" type="checkbox"/>	<input type="checkbox"/>	<input type="checkbox"/>
• Does elevator provide audible and visible signals?	<input checked="" type="checkbox"/>	<input type="checkbox"/>	<input type="checkbox"/>
• Floor of elevator cab is min. 51" x 68" (door offset) or 51" x 80" (door centered)?	<input checked="" type="checkbox"/>	<input type="checkbox"/>	<input type="checkbox"/>

Restrooms

• Door hardware is lever handles, pulls, or push-pull activating bars?	<input checked="" type="checkbox"/>	<input type="checkbox"/>	<input type="checkbox"/>
• Do restroom entrance doors have at least 32" wide clearance?	<input checked="" type="checkbox"/>	<input type="checkbox"/>	<input type="checkbox"/>
• Is restroom large enough for wheelchair turnaround (5' diameter)?	<input checked="" type="checkbox"/>	<input type="checkbox"/>	<input type="checkbox"/>
• Does accessible stall door have at least 32" wide clearance?	<input checked="" type="checkbox"/>	<input type="checkbox"/>	<input type="checkbox"/>
• Are grab bars provided in accessible toilet stalls?	<input checked="" type="checkbox"/>	<input type="checkbox"/>	<input type="checkbox"/>
• Toilet seat top is 17-19" above floor?	<input checked="" type="checkbox"/>	<input type="checkbox"/>	<input type="checkbox"/>
• Sink has clear knee space under basin; exposed pipes are insulated?	<input checked="" type="checkbox"/>	<input type="checkbox"/>	<input type="checkbox"/>
• Faucets are lever-operated or push-type?	<input checked="" type="checkbox"/>	<input type="checkbox"/>	<input type="checkbox"/>
• Are soap and towel dispensers no more than 40" from the floor?	<input checked="" type="checkbox"/>	<input type="checkbox"/>	<input type="checkbox"/>

Reception and Personnel Office

• Lower counter space in reception, customer service areas?	<input checked="" type="checkbox"/>	<input type="checkbox"/>	<input type="checkbox"/>
• Do doors have at least 32" wide clearance?	<input checked="" type="checkbox"/>	<input type="checkbox"/>	<input type="checkbox"/>
• Is the door easy to open (max. 5 lbs. opening force)?	<input checked="" type="checkbox"/>	<input type="checkbox"/>	<input type="checkbox"/>
• Door threshold is maximum 1/4" high (1/2" if beveled)?	<input checked="" type="checkbox"/>	<input type="checkbox"/>	<input type="checkbox"/>
• Is the path of travel between furniture at least 36"?	<input checked="" type="checkbox"/>	<input type="checkbox"/>	<input type="checkbox"/>

Required Number of Accessible Parking Spaces

Total Garage/Lot Parking Spaces	Minimum No. of Accessible Spaces
1-25	1 (van accessible)
26-50	2 (including one van space)
51-75	3 (including one van space)
76-100	4 (including one van space)
101-150	5 (including one van space)
151-200	6 (including one van space)
201-300	7 (including two van spaces)
301-400	8 (including two van spaces)
401-500	9 (including two van spaces)
501-1000	2% of total spaces (every six accessible spaces include one van space)
More than 1000	20, plus 1 for each 100 over 1000 (every six accessible spaces include one van space)

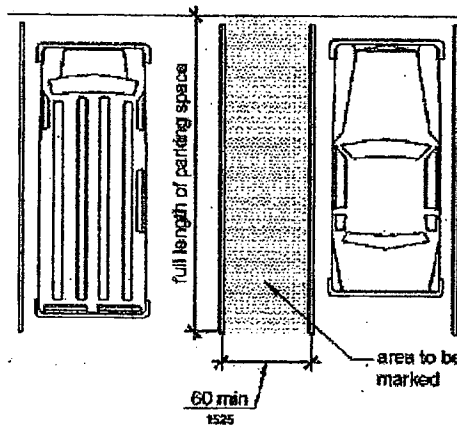

Locate accessible parking spaces on the shortest accessible route of travel to an accessible building entrance (where practical, not crossing traffic lanes).

Car and van parking spaces shall have an adjacent access aisle. Two parking spaces may share an access aisle. Van parking spaces that are angled shall have access aisles located on the passenger side of the parking space.

If there is only one accessible parking space, then it shall meet the codes for a van accessible parking space: 11' wide vehicle parking space plus a 5' access aisle. (An 8' vehicle parking space with an 8' access aisle is acceptable under code.)

For more detail, consult Washington State Building Code (WAC 51-50).

504/ADA DISABILITY ASSURANCE OF COMPLIANCE

Complying with Section 504 of the Rehabilitation Act of 1973, as amended, and the Americans With Disabilities Act of 1990, two federal laws which prohibit discrimination against qualified people with disabilities.

I understand that federal and state laws prohibit discrimination in public accommodations and employment based solely on disability. In addition, I recognize that Section 504 requires recipients of federal funds (either directly or through contracting with a governmental entity receiving federal funds) to make their programs, services, and activities, when viewed in their entirety, accessible to qualified and/or eligible people with disabilities. I agree to comply with, and to require that all subcontractors comply with, the Section 504/ADA requirements. I understand that reasonable accommodation is required in both program services and employment, except where to do so would cause an undue hardship or burden.

I agree to cooperate in any compliance review and to provide reasonable access to the premises of all places of business and employment and to records, files, information, and employees therein to King County for reviewing compliance with Section 504 and ADA requirements.

I agree that any violation of the specific provisions and terms of the 504/ADA Disability Assurance of Compliance and/or Corrective Action Plan required herein or Section 504 or the ADA, shall be deemed a breach of a material provision of the Contract between the County and the Contractor. Such a breach shall be grounds for cancellation, termination, or suspension, in whole or in part, of this Contract by the County.

According to the responses to the questions in the 504/ADA Self-Evaluation Questionnaire, Contractor is in compliance with 504/ADA. If the response is NO, the actions outlined in the below Corrective Action Plan will be taken. YES NO

Contractor: Society of Counsel Representing Accused Persons
Company Name
1401 E Jefferson St Ste 200 Seattle WA 98122
Street Address City State Zip

Corrective Action Plan

The following Corrective Action Plan is submitted to comply with Section 504 and ADA requirements.

General Requirements

Actions To Be Taken	Completion Date

504/ADA DISABILITY ASSURANCE OF COMPLIANCE (continued)

Actions To Be Taken	Program Access	Completion Date
<hr/>		
<hr/>		
<hr/>		

Actions To Be Taken	Employment and Reasonable Accommodation	Completion Date
<hr/>		
<hr/>		
<hr/>		

Actions To Be Taken	Physical Accessibility	Completion Date
<hr/>		
<hr/>		
<hr/>		

Declare Under Penalty of Perjury under the Laws of the State of Washington that the Foregoing is True and Correct.

Signature of authorized signator

Type or print name of authorized signator Title Telephone

For Notary:

State of _____, County of _____

Signed and sworn before me on (date) _____ by (print authorized signator name) _____

Notary signature: _____

Notary (print name): _____

My appointment expires: _____

Note: This form may be used as an exhibit with other King County contracts for two years from the date the form is completed.

EXHIBIT V

PUBLIC DEFENSE LEGAL SERVICES

I. WORK STATEMENT

The Agency shall provide the services of attorneys and staff members in compliance with all of the applicable laws and administrative regulations of the State of Washington, the United States, King County Code (KCC), Washington State Rules for Professional Conduct (RPC).

II. PROGRAM DESCRIPTION

A. Goal

To provide legal services through effective assistance of counsel to indigent persons, that is statutorily and constitutionally based, within the framework of an efficient and fiscally responsible independent non-profit Agency.

B. Eligible Population

The population served shall be indigent persons legally entitled to appointed legal services in King County courts as assigned by the Office of The Public Defender (OPD) or as appointed from the bench.

C. Definitions

1. Case Categories:

a. Becca: CHINS/ARY/Truancy practice area:

i. CHINS/ARY Petition: A Child in Need of Services (CHINS) petition and At Risk Youth (ARY) petition involves the representation of one child or one parent from the filing of the petition through conclusion of services related to the petition. This includes representation on the initial petition, as well as any subsequent review hearings. In the event that a court consolidates a truancy matter with proceedings under a Youth at Risk or Child in Need of Services Petition, the Agency shall receive credit for the truancy representation.

ii. Truancy: A petition filed under Revised Code of Washington (RCW) 28A.225.030. A case assignment will be made when the Court notifies OPD of a signed judicial order, setting a show cause hearing for Contempt of Court and requiring appointment of counsel.

b. Calendars: The Agency shall provide coverage for calendars if indicated in Attachment B, Calendar Attorney and Staff List. The calendars are defined as follows:

- i. Dependency Calendar: All initial 72-hour shelter care calendars in Seattle or Regional Justice Center (RJC) shall include the presence of an attorney.
- ii. General Attorney of the Day (AOD): The Agency will in good faith attempt to provide legal advice 24 hours a day seven days a week via beeper access and respond promptly to any accused adult or juvenile who is in the investigation phase or recently charged with a crime or detained on a civil matter within the jurisdiction of OPD. AOD for legal advice may occur both in RJC and Seattle. AOD includes a request from a defendant for substantial legal advice or a police agency to respond for line-up presentations. A call to the 24 hour beeper is calendar work not a case assignment.

Where substantial advice services are provided as a result of initial General AOD contact via beeper, credits can be requested as per Attachment A. "Substantial advice" includes legal services beyond providing of simple direct, one-time legal advice by phone or in person at a detention facility, and includes ongoing legal services preliminary to a formal appointment as counsel for prospective client.

Individual substantial advice assignments may also be appointed by the court or assigned by OPD, where the scope of work exceeds that described in the General AOD paragraph above.

- iii. Felony Arraignment Calendar.
- iv. Felony Sentence Modification Calendar: The Superior Court Probation Modification Calendar.
- v. Juvenile AOD: The Agency shall provide Juvenile Special Services which include making "morning rounds" in juvenile detention; lineups, detention reviews and arraignments; diversion counseling per RCW 13.40.080; and representing offenders as counsel until an attorney is formally appointed.
- vi. Juvenile First Appearance Calendar: Each Agency representing juveniles shall provide representation on the Juvenile First Appearance Calendar. Representation of juveniles on this daily Juvenile Court Calendar shall include prior clients and/or unrepresented juveniles. Time spent on this calendar shall include preparatory work done concerning the juveniles listed on the calendar who do not appear because of expedited filing by the Prosecuting Attorney, release from detention prior to hearing, or other reasons for non-appearance.
- vii. King County Court Misdemeanor calendars include: District Court Felony Investigation Calendar, Bench Warrant Return Calendar, and initial detention hearings for new misdemeanor charges.

- c. Civil Contempt of Court practice area: A civil contempt case shall include legal representation up to a maximum of three hearings, related solely to a contempt citation and shall be limited to cases where the factual likelihood of loss of liberty arises from an act of King County or the State of Washington or a judicial act.
- d. Dependency practice area: Coverage for all dependency, termination, guardianship, dependency guardianship, contested private adoption termination, and Reinstatement of Parental Rights cases.
 - i. Dependency Case: A dependency case credit is given for the legal representation of a client from:
 - 1) The initial predispositional assignment through the dispositional hearing. Should an agreed order of dependency be entered on or before the date of the 30-day shelter care review, it shall be considered part of the dependency case. If the case is assigned to the Agency after the establishment of dependency and entry of the dispositional order, an initial case credit shall be given at the time of assignment; and
 - 2) The filing of a termination or guardianship petition to the setting of a termination or guardianship trial date. Should an agreed order of termination or guardianship be entered on or before the preliminary hearing, it shall be considered part of the termination or guardianship case.
 - 3) Appointment of counsel pursuant to RCW 26.33.110 for contested private adoption termination shall be considered a termination of parental rights appointment for credit purposes. The Agency shall not be required to have more than two open RCW 26.33.110 cases at a given time.
 - ii. Post-Dispositional Hearing: A dependency review shall include legal representation at any post-dispositional hearing or hearings related to the original dependency filing, excluding the initial 72 hour shelter care review, the 30-day shelter care review, and the dispositional hearing. Reviews included within this category shall include, but not be limited to: the initial progress review, six month review hearings, permanency planning hearings, new shelter hearings occurring post disposition, or other reviews or hearings set by the parties or by the court. If a review hearing is continued, additional credit shall not be allocated for the review unless the substantive issues within the review hearing change or substantial work is done. In the event that a court consolidates a family court matter with proceedings under a dependency case, pursuant to Local Juvenile Court Rules (LJuCR) 3.13, the Agency shall receive additional dependency review credit under this section for representation involving hearings in the consolidated matter.

iii. Dependency Trial/Termination or Guardianship Trial

1) A dependency trial shall include:

- a) A fact finding for a dependency and the preparation for said fact finding or the entry of an agreed order of dependency and agreed dispositional order at the time of the scheduled dependency fact finding; or
- b) Entry of an agreed order of dependency and any contested hearing or hearings related to the dispositional order pursuant to the agreed order, as described in RCW 13.34.110 (1) and (2). This does not include post-dispositional review hearings.

2) A termination trial shall include:

- a) A fact-finding on a termination petition or guardianship petition and the preparation for said fact finding; or
- b) Entry of an agreed order regarding termination or guardianship petition at the time of the scheduled fact-finding.

iv. If more than one petition is pending involving one client, only one case shall be allowed credit. If matters involving one client with multiple petitions are severed for separate proceedings on different petitions, credit shall be given for such hearings. In the event that a new petition is filed as to a parent involving a child not previously involved in prior proceedings and that petition is filed post-disposition of previously filed petitions, then a new case credit will be allowed on the newly filed petition.

v. Reinstatement of Parental Rights Matters: Representation of a client from the time of appointment of counsel through completion of the matter to point of either completed reinstatement of parental rights, or dismissal of the Petition for Reinstatement of Parental Rights. To the extent that any hearings held in this matter are also concurrently a permanency plan hearing or review hearing in the related dependency matter, no additional review credits are given for those hearings for purpose of the related dependency matter.

e. Felony practice area:

i. Felony Case: All legal representation related to a case filed in the Criminal Division of King County Superior Court by the King County Prosecutor's Office, alleging a violation of criminal law and having a maximum sentence of more than one year, through sentencing and any restitution hearing and as listed in Attachment A.

- ii. **Felony/Probation Review:** A felony/probation review shall include legal representation at any hearing or hearings arising from a single notice of hearing subsequent to disposition of the case. Areas within this category shall include, but not be limited to: probation reviews, revocations, early release, conditional release, safe-to-be-at-large, temporary release, medical release, and material witness hearings. A restitution hearing will be a review only if it is assigned to an agency other than the agency which represented the client at sentencing.
- iii. **Persistent Offender (I 593 C 1 L 94; RCW 9.94A.030(33); RCW 9.94A.570):** Persistent offender is a defendant as defined by RCW 9.94A.030(33) and subject to sentencing pursuant to RCW 9.94A.570. The Agency shall provide documentation to OPD to verify a persistent offender case status.
- iv. **Complex Litigation:** All death penalty homicide cases and all aggravated homicide cases. Aggravated homicide cases are considered death penalty cases until such time as decision is made by the Prosecuting Attorney not to file a notice of intention to seek death.
 - 1) Complex litigation cases are "pending" until completion of the guilt phase and penalty phase/sentencing.
 - 2) Aggravated homicide cases, in which the death penalty is not sought, shall occupy the portion of a full time attorney up to a maximum of one Full Time Employee (FTE) qualified at Senior Public Defense I level or above. Up to 0.5 FTE professional support staff will be assigned to each such case. Active Supervision will be assigned at up to 0.1 FTE.
 - 3) Aggravated homicide cases, in which the death penalty is sought, shall occupy the portion of two full time attorneys, up to a maximum of two FTE attorneys, deemed necessary by the Agency to provide effective assistance of counsel. The attorney component shall comply with SPRC 2, Superior Court Special Proceedings Rules – Criminal, as well as one FTE qualified at Senior Public Defender I, or above. A professional support staff will be assigned up to one FTE. Active Supervision will be assigned at up to 0.2 FTE.
 - 4) The Agency and the County understand that the portion of attorney(s) and professional support staff assigned to each complex litigation case may change from time to time as the case moves through the adjudication process. In the event that a case concludes sooner than scheduled in Attachment B, case credit allocation will be adjusted accordingly.

f. **Involuntary Commitment practice area:**

- i. Initial Petition: An involuntary commitment case shall include any hearing on a petition for involuntary commitment under one cause number including a hearing for probable cause, or any petition for additional commitment under the same cause number pursuant to RCW 71.05.280, except such hearings defined in (ii) and (iii) below.
 - ii. 180-Day Petition: Any involuntary commitment case that went to a 180-day hearing following a petition filed pursuant to RCW 71.05.320 shall be considered a separate case and shall be billed by client name and shown separately. When a new docket number is assigned and the first court appearance is a 180-day hearing, the Agency will receive case credit and payment for either the assignment of the new docket number or the 180-day hearing, but not both.
 - iii. Involuntary Medication Hearing: A hearing held pursuant to a petition for involuntary administration of medications or electroconvulsive therapy shall be considered a separate case.
 - iv. An alcohol involuntary commitment proceeding filed pursuant to RCW 70.96A including all hearings under the same cause number shall be considered one case.
 - v. A drug-related involuntary commitment filed pursuant to RCW 70.96A including all hearings under the same cause number shall be considered one case.
- g. Juvenile Offender practice area: Coverage for all juvenile cases filed in juvenile court, including Diversion Calls.
- i. Juvenile Offender Case: A juvenile offender case includes any criminal charge filed by the King County Prosecutor's Office in King County Juvenile Court. A restitution hearing is included within the initial case credit.
 - ii. Juvenile Offender Modification/Review: A juvenile offender modification/review shall include a hearing or hearings related to the allegations contained in the notice of the modification/review. In the event that the juvenile respondent has several notices of modification/review because of different cause numbers and all such modifications/reviews are heard at a single hearing, then such hearing shall constitute one completed juvenile offender modification/review.
 - iii. Juvenile Offender Restitution Review Hearing: A juvenile offender restitution review hearing consists of a hearing or hearings related to the subsequent modification of restitution schedules set by the court for the particular juvenile offender. In the event that the juvenile has several pending restitution hearings and such hearings are all heard at the same hearing, then such completed hearing shall constitute one completed restitution review hearing.

- h. Misdemeanor practice area:
 - i. Misdemeanor Case: Any criminal case, including traffic misdemeanors, filed by the King County Prosecutor in the District Courts.
 - ii. Misdemeanor Appeal: A misdemeanor appeal involves filing the notice of appeal, if necessary, perfecting the record following the filing of the notice of appeal, preparation of the transcript pursuant to Rule 6.3a Rules for Appeal of Decisions of Courts of Limited Jurisdiction (RALJ), preparing such briefs and memoranda as are required, arguing the case in Superior Court, and handling such paperwork as the Superior Court's decision and orders direct.
 - iii. Misdemeanor Writ: A writ involves filing notice, perfecting the record, preparing such briefs and memoranda as required, arguing the case in Superior Court and handling such paperwork as the Superior Court's decision and orders direct.
- i. Sexual Predator practice area: Legal representation for indigent persons assigned by OPD for cases filed under RCW 71.09, civil commitment petitions filed by the King County Prosecuting Attorney or the Attorney General's Office, subject to such conditions stated in the current Program Agreement, and General Terms Agreement between the County and the State of Washington Department of Social and Health Services (DSHS) from the effective date of these agreements, and directly invoice to and be reimbursed by DSHS at a rate determined by DSHS or as ordered by the Court.
- j. Specialty Court practice area:
 - i. Specialty Court/Drug Court: Any criminal case filed into King County Superior Court Drug Court. Staffing is determined by a separate agreement, which is incorporated by reference herein.
 - ii. Specialty Court/District Mental Health Court includes: Any case filed into King County District Mental Health Court. Staffing is determined by a separate agreement, which is incorporated by reference herein.

- 2. Case Credit: Case credit is a unit of work. The total number of units that an attorney is expected to perform is listed in the case credit workloads of Section III. Program Requirements, of this Exhibit. Attachment A of this Exhibit defines the Case Credit Application and parameters for additional credit in extraordinary cases.

Extraordinary Case Credit: Extraordinary case types including Juvenile Felony Offender, Contempt of Court, Dependency, Termination of Parental rights, RCW 26.33.110 contested adoption termination, Reinstatement of Parental Rights, Murder, Persistent Offender, and all Adult Felony cases shall be given extra credits if the nature of the case requires such extra credits, based upon a written application from the Agency. Other case types may be approved for

extraordinary credit at the discretion of OPD. Factors entering into the awarding of extra credits shall be as according to Attachment A.

3. **Criminal Case:** A case is any one charge or series of related charges filed against one defendant/respondent in a single charging document or in the case of misdemeanors a series of charges under several charging documents, set for one court hearing that will ultimately lead to one disposition.
 - a. If a related series of charges is defined herein as a single case is subsequently set for separate disposition hearings or trials, the Agency may request additional credit for each case, which is severed from the consolidated case.
 - b. If a new case is filed on a separate incident after case has been assigned, and a new count is charged but not a new court case number, the Agency may request additional credit for each case similarly filed. An incident is defined as a criminal charge alleged to have occurred on or about a specific calendar day. Multiple offenses charged as occurring on or about the same date are considered a single incident. A maximum of three credits shall be allowed, if requested by the Agency, per charging document regardless of the number of incidents alleged. Agency may apply for Extraordinary Case Credit if appropriate.
 - c. Criminal charges alleged to have occurred on indeterminate dates or during a specified range of dates (e.g. on or between specific dates) are considered one incident. The Agency may present documentation to OPD to demonstrate that separate and discreet dates of incident were intended. Documentation should include such portions of pre-trial discovery to justify claim for separate incidents. In the event that such separate incidents are determined, a maximum of three credits shall be allowed, if requested by the Agency, per charging document.
 - d. A completed case involves all necessary legal action from arraignment through disposition. This includes the filing of a notice of appeal upon the client's request, application to proceed in *forma pauperis* on appeal, and a motion for appointment of appellate counsel.
 - e. A case remanded to the trial court for proceedings following appeal is a new case credit. The filing of an appeal (interlocutory appeal which is accepted for review by the appellate court or post-dispositional) closes the case for credit purposes.
4. **Criminal Case Disposition:** Case disposition shall mean the dismissal of charges, the entering of an order of deferred prosecution, an order or result requiring a new trial, imposition of sentence or deferral of same, or dispositional continuance and any other hearing on that cause number that occurs within 45 days of sentence, entry of an order for deferral of sentence, or dispositional continuance by District Court. Sentencing includes completed hearing on establishing restitution order. A motion to modify restitution shall be considered for additional credit if the motion occurs after 180 days.

A restitution hearing ordered at the time of original disposition shall be included as part of the case credit as defined by this disposition description. It shall

include the filing of a notice of appeal, if applicable. It shall not include a felony or misdemeanor probation review unless such review occurs within 45 days of disposition. Additionally, it shall not include any hearing ordered at the conclusion of a deferred sentence unless such hearing occurs within 45 days of sentencing.

5. **Indigent:** An indigent defendant is a person determined indigent by OPD or the Court as being eligible for a court-appointed attorney, pursuant to RCW 10.101, 13.34.090, and OPD policy. Defendants may be considered assigned until a screening for indigency is completed, pursuant to RCW 10.101.020(4). Defendants may be required to be re-screened if their financial situation changes or at each 180 days of Agency representation. If a defendant is found to be not indigent, OPD will inform the Agency and court. In the event the court removes the Agency from assignment or orders the Agency to withdraw as appointed counsel, credit for such representation by the Agency is determined by the terms of this Contract, including the relevant sections of Attachment A.
6. **Legal Services:** Legal service is legal representation provided by an individual licensed attorney, and associated professional support staff to an individual client, pursuant to a case assignment or court appointment. The attorney will be required by the Agency to satisfy the Code of Professional Responsibility, the law of the State of Washington and the United States in the full discharge of the duties to each individual client under this Contract.
7. **Professional support staff:** Investigators, social workers and paralegals.
8. **Supervision:** An attorney with significant experience who is capable of actively monitoring an attorney's work product, caseload management, and relationship with clients and is capable of providing legal advice and guidance in other areas relevant to assuring high quality staff attorney performance. The Agency will provide active supervision for each staff attorney, in the ratio of one supervisor per ten staff attorneys.

III. PROGRAM REQUIREMENTS

A. Services

1. **Case Credit Allocation and Case Assignment:**
 - a. OPD shall make reasonable efforts to maintain the Agency at the total case credit allocation and case assignment as shown on Attachment B of this Exhibit, for each quarter of the year. The quarterly case credit amounts in Attachment B are provided for planning purposes. OPD shall make reasonable efforts to distribute cases beyond variance consistent with the case credit allocation in Attachment B of this Exhibit and paragraph b. below. The variance in case distribution does not apply to calendars, specialty court agreements, complex felony cases, or Sexually Violent Predator cases.
 - b. The Agency shall accept case assignments within contracted subject areas, including case assignments above the projected variance levels. Agency refusal to accept an individual case assignment within contractual subject areas shall not in and of itself be considered a

material breach of this Contract, however the County may determine such refusal requires Agency corrective action. The County shall pay the Agency for work in excess of the variance levels according to Section IV of this Exhibit.

- c. The Agency shall accept all complex litigation cases as determined by OPD, after consultation with the Agency concerning capacity.
 - d. If the Agency has begun delivery of legal services and the defendant/respondent absconds for a period of 180 days or more, upon re-apprehension, the allocation of a new case credit shall be determined by OPD.
 - e. If the Agency is assigned to a case prior to arraignment, has not provided legal services, and the defendant fails to appear for arraignment, the case shall be returned to OPD within 30 days or as agreed with OPD, and the Agency shall be debited.
 - f. If, after initial assignment, additional charges are filed under the same cause number against the same defendant/respondent, and said charges arise out of a different allegation or series of allegations unrelated by transaction to the first charges, then additional case credit shall be granted according to paragraphs II.C.2, 3, and 4 above.
 - g. The Agency may be appointed by the court as standby counsel in pro se cases. If such appointment is made, the Agency shall receive one case credit, less previous credit assigned for case. The Agency is not necessarily expected to utilize its professional support staff for pro se case work. If professional support staff work is requested by the pro se defendant, the Agency may opt to reduce its credit allocation by 0.1 per case credit allocated by not utilizing Agency professional support staff. In the event that the Agency elects to not provide professional support staff services, then it is the responsibility of the pro se defendant to comply with OPD Expert Services protocols regarding requests for any such services as may be necessary. Standby counsel shall provide such assistance and advice as may be ordered by the court and otherwise as consistent by case law and other legal requirements, and applicable standards of attorney representation and attorney conduct, including pro se requests for expert services.
 - h. The Agency shall electronically file a Closed Case Report (Attachment D) each month with OPD which shall include all information requested in the report for the month indicated and be submitted to OPD no later than 20 days following the last day of the previous month. A case is considered closed for further credit for attorney time expended after 30 days past sentencing, or a dispositional order is filed, or upon filing of a Notice of Appeal, unless an additional court order appoints counsel.
2. Funds for payment for expert services are not included in this Exhibit. Requests for appointment for expert service shall be made following OPD procedure for allocation of expert services. The Agency must assure that its staff follows the OPD expert procedures, as agreed with OPD.

3. The Agency shall fully participate as requested by the County in Superior Court and OPD planning and responsibilities for providing services in the event of a natural disaster, a major disruption to court processes, or a pandemic. The Agency shall develop and maintain disaster plan protocols which shall include a provision for daily contact with OPD and the Courts to verify court calendars requiring counsel presence. The parties acknowledge that all such plans presume the continued ability to communicate between the Agency and OPD. OPD shall assist the Agency in coordination with the courts and general implementation of the disaster plan.

The Agency shall submit within six months of the execution of the Contract the necessary plans, procedures and protocols to respond to and recover from a natural disaster or major disruption to agency operations such as a work stoppage; and continue operations during a prolonged event such as a pandemic. The plans shall be consistent with written County disaster plans for purposes of continuation of court business in the event of a disaster.

B. Practice Standards and Records

1. The Agency shall require that all attorneys, professional support staff and supervisors maintain contemporaneous records of all legal services provided on a specific case. The records shall provide a factual description of the work done and shall be sufficiently detailed to allow monitoring of legal service activity by OPD.
2. Upon closing a case, all attorney, professional support staff and supervisor files associated with the case shall be cross referenced and accessible as a whole for OPD monitoring.
3. The Agency shall maintain professional practice standards in providing a level of legal service that does not fall below the minimum professional standards and RPCs of the Washington State Supreme Court, the Washington State Bar, the National Legal Aid & Defender Association, and any applicable case law and court rules that define the duties of counsel to their clients. The Agency shall formally adopt the internal Agency practice standards as submitted to OPD February 1, 2006, and shall include a procedure for monitoring compliance with the standard. Case credit workload standards shall be according to paragraph III.B.14. below.
 - a. Attorney practice standards, include but are not limited to:
 - i. Lawyer-client relationship, initial case actions, investigation and preparation, preliminary hearings; disposition without trial; trial; post conviction or fact finding and any other areas of attorney practice deemed appropriate by Agency management or Board.
 - ii. Attorney use of professional support staff services and expert services.
 - b. Professional support staff service practice standards.
 - c. Practice standards for supervision of attorneys and professional support staff services.

4. The Agency agrees that, within available resources, reasonable efforts will be made by the Agency to continue the initial attorney assigned to a client throughout any case in which representation is undertaken. The Agency is not prohibited from rotating attorneys through various Agency divisions or from assigning a single attorney to handle various aspects of legal proceedings for all indigent persons where such method of assignment is the most reasonable method of obtaining effective legal representation for indigent persons.
5. The Agency agrees that a member of the Agency staff shall visit any assigned in-custody criminal defendant, in-custody civil commitment, or dependency clients, and obtain basic contact and other fundamental intake information for a bond hearing within one business day from notification to the Agency of the assignment of the case and the in-custody status of the client, and/or within one business day upon notification of transport to a local detention facility. This provision applies to clients in custody at any facility within the King County jail. If a client is in custody in a non-County jail, the Agency shall make contact within three business days of receiving the assignment.
6. The Agency agrees that an attorney shall make contact with all assigned persons within five working days from a case assignment, or in rare occurrences where this is not achieved the Agency shall document reasonable efforts to make said contact.
7. The Agency agrees that a preliminary written response to any written complaints from OPD concerning services provided by the employees of the Agency or the Agency itself shall be submitted to OPD within three working days of the date the complaint is received by the Agency Director or the Director's designee. Written complaints include email communications from OPD; email response date will be provided.
8. Upon assignment of any client charged with a criminal case to an Agency, the Agency shall make diligent and reasonable efforts to obtain discovery within five business days of the assignment, whether initial or subsequent, on any case. In all cases, discovery shall be reviewed as soon as possible and in no event later than five business days after receipt for purposes of determining any conflicts of interest. The Agency shall notify OPD immediately and no later than 14 calendar days from assignment without good cause shown, of any conflict of interest as defined by the Washington State Rules of Professional Conduct. The Agency shall state the basis when possible, as court determines, for the conflict in its written notification.
9. The Agency shall establish and enforce policies and procedures to ensure that attorney time and other Agency resources funded by this Contract shall be for work, which is the subject of this Contract.

The Agency shall establish policies and procedures for pro-bono work provided by staff of the Agency. These policies and procedures shall assure that any such pro bono work is not provided to the exclusion or detriment of legal services that are the subject of this Contract.
10. Attorney Professional Support Staff

The Agency shall provide sufficient professional support staff, including investigators, social workers and paralegals to provide for effective assistance of counsel.

11. Minimum Attorney Qualifications

- a. Attorneys shall have the requisite qualifications for the cases to which they are assigned by the Agency, consistent with Washington State Bar Association (WSBA) Standards for Public Defense Services, Standard Fourteen, Qualifications for Attorneys, as adopted in 2007 and as may be amended by WSBA during the Contract period.
- b. Each staff attorney representing any client assigned by OPD shall work under the supervision of a supervising attorney employed by the Agency. Such supervision shall provide the staff attorney with sufficient resources so the attorney will be able to handle cases on his/her own. The employees of the Agency are not employees of the County and the County will not provide supervision to any of the Agency's employees.
- c. The Agency may choose to use Rule 9 Interns or Rule 8 attorneys, as allowed by Washington State Bar Association regulations.

12. Attorney/Professional Support Staff Evaluation

The Agency director, or his/her designee, shall evaluate the professional performance of each individual Agency attorney and professional support staff member annually. Attorney evaluations shall include: quality of case preparation, compliance with the requirements of this Contract, monitoring of time and caseload records, review of case files, and in-court observation.

Professional support staff evaluations shall be sufficiently comprehensive to assess the quality of the actual work performed.

The Agency shall keep a written record of all required performance evaluations.

13. Attorney/Professional Support Staff Training

The Agency shall provide access to sufficient training to support attorney and professional support staff performance of duties under this Contract. The Agency shall maintain all necessary records to assess the adequacy of the training. A Continuing Legal Education (CLE) approved by the Washington State Bar Association is presumptively adequate.

At a minimum during the Contract period, the Agency shall require each attorney to attend at least seven WSBA approved credits of CLE in a practice area under this Contract. Each Agency attorney must attend training approved by WA State OPD, pursuant to RCW 10.101.050 and as posted on WA State OPD website, at least once per calendar year. Each Agency attorney also shall satisfy the minimum requirements for practicing law in the State of Washington as determined by the Washington Supreme Court.

14. Case Credit Workload Guidelines

The County shall review Agency case credit workloads, case assignments, standards, and support staff/attorney ratios for each area of cases to assess compliance with the requirements of this Contract.

The total amount of reimbursement included in this Contract resulted from the application of the Public Defense Payment Model approved by the King County Council by Motion 12160 on July 18, 2005. Pursuant to the policies stated in Motion 12160, the allocation for each case area was calculated to provide funding for public defenders at parity with similarly situated attorneys in the Office of the Prosecuting Attorney. The Agency's staffing plan may be reviewed by OPD to verify that an attorney's experience level meets or exceeds required experience for case practice area, and placement within the salary schedule is reasonable. The Agency agrees to comply with the following average annual case credit work loads per attorney per case type:

Supervisors	0
Felony	150
Complex	150
593	150
King County Misdemeanor	450
Juvenile*	330
* KCC Motion supplemented by WA State funds (see Att C of this Exhibit) to allow effective caseload of 250	
Dependency	180
Becca	(refer to IV.H. of this Exhibit)
Contempt of Court	225
Involuntary Treatment Act (ITA)	410

A supervisor, including a managing director or assistant director, may provide minimal representation to clients under this Exhibit solely for the purpose of addressing management issues, emergencies or caseload overflow beyond the projections. OPD shall be notified of primary representation by supervisory staff constituting a caseload that exceeds available one to ten ratio of supervisory availability.

15. The Agency agrees to abide by the OPD Withdrawal procedures (Attachment E) when declining a case or withdrawing from a case because of a conflict of interest. Agency may withdraw only pursuant to applicable court rules and RPCs. Agency attorney shall promptly notify the court of any conflict of interest or any other reason requiring withdrawal from a case assigned under this Exhibit. The Agency shall submit the Withdrawal form to OPD and the case will be re-assigned by OPD upon receipt of signed Court Motion or if case is an early assignment (pre-court appointment) from OPD, OPD may re-assign the case in advance of Court appointment and/or Motion. Credits shall be applied according to the terms of this Exhibit, including Attachment A.

16. The Agency shall report all extraordinary occurrences to OPD in accordance with the Extraordinary Occurrences Policy and Procedure, and cooperate with any OPD extraordinary occurrence review. The Agency shall adopt an Agency specific extraordinary occurrence policy. The requirement to report to OPD does not replace reporting requirements by other entities.
17. The Agency shall have a process for the filing and review of complaints that are brought to the Agency's attention by clients, OPD, or other criminal justice system staff. The Agency shall establish an internal complaint procedure that is accessible to all clients, in accordance with RCW 34.05, 49.60, RPCs, and the OPD Client Complaint Services Policy and Procedure. The Agency shall maintain a file system for reliable report backup of each complaint.
18. The Agency agrees to abide by the terms of the OPD Attorney Supervision Policy and Procedures.
19. The Agency shall have an Information System (IS) that can report accurate data to OPD, and shall comply with the OPD IS Policy and Procedure. The Agency shall have functional personal computers using a Windows Operating System version 2000 or above and shall be connected to the Internet with the following supports:
 - a. The Agency shall have at least one trained primary and one trained backup on-site IS support person who has training on Basic Administration of Windows 2000, and other basic software training.
 - b. The Agency shall notify OPD, in writing, of staffing changes (i.e. new hires, transfers, and terminations) for those staff directly responsible for data reporting and IS maintenance.
 - c. If a virus attacks an Agency computer, Agency response must be immediate (i.e. within 15 minutes) to take the computer off line and other appropriate action.

IV. COMPENSATION AND METHOD OF PAYMENT

- A. The Agency shall be paid monthly as provided in Attachment C of this Exhibit except as paragraph IV B. applies. The Payment Schedule shall pertain to all cases assigned to the Agency from January 1, 2008 through December 31, 2008. The Agency shall submit reports in a format approved by the County, as stated in Section V. Reporting Requirements of this Exhibit. The reports are due within ten days after Agency receipt of the OPD Case Credit Certification Report.
- B. Payment shall be made monthly, subject to performance requirements being met and upon completion of scheduled corrective action requirements noted in the OPD 2007 site visit review and the Agency plan for corrective action. For each corrective action due date missed by the established due date, one percent of the subsequent month's payment will be withheld until action is completed or report is received and accepted by the County.
- C. Payments may be made for extraordinary expenses that are in addition to those payments shown in Attachment C, Payment Schedule. Extraordinary expenses shall be approved in writing in advance of the expenditure by OPD.

- D. In the event that workload demand exceeds the projected levels, the Agency shall accept case assignments and case credits above the variance levels on a monthly basis. OPD will monitor the distribution on a cumulative monthly basis to ensure that a reasonable distribution of cases has been maintained.
- E. For quarterly and annual payment purposes, the variance shall be no more than five percent, for all case areas except felony cases, which shall have a variance of no more than two-and-one-half percent. These variance percentages will be applied to the projected caseload to establish the variance range.
- F. Quarterly reconciliation: At the end of each quarter, OPD will evaluate the case credit accumulation for each Agency for each case type. Action taken will be as follows:
1. The actual quarterly caseload for each type of case area, as shown in the quarterly Certified Statistics will be compared to the actual variance range, for each practice area. Variance does not apply to calendars, specialty court agreements, or Sexually Violent Predator cases.
 2. If the Agency's actual quarterly caseload falls within the high and low values of the variance, an adjustment to the reimbursement will not be made.
 3. If the Agency's actual quarterly caseload falls outside of either the high or low values of the projected variance range, an adjustment to the payment may be made.
 4. If a quarterly reconciliation results in payment due to the Agency from the County, the Agency may, at the Agency's option, defer such payment to a later month in the Contract year.
 5. If the quarterly reconciliation results in payment due to the County from the Agency, the County may, at the County option, defer such payment to a later month in the Contract year.
- G. Year end reconciliation: The final payment will be the result of a reconciliation of actual performance to Contract specifications. The reconciliation will be conducted as follows:
1. The annual variance percentages outlined in Section III. Program Requirements will be applied to the projected caseload to establish the variance range.
 2. The actual annual caseload for each type of case will be compared to the variance range for each type of case, except for complex felony cases, calendars, specialty court agreements, or Sexually Violent Predator cases.
 3. If the Agency's actual annual caseload falls within the high and low values of the variance, an adjustment to December reimbursement will not be made.
 4. If the Agency's actual annual caseload falls outside of either the high or low values of the projected variance range, an adjustment to the final payment will be made.
- H. Becca Cases: The Agency shall be paid by OPD for CHINS, ARY, and Truancy legal services from funds provided by the State of Washington through King County Superior

Court, Juvenile Court Services, and such additional funds as may be made available by King County.

1. Truancy. Truancy cases will be counted as one credit for the filing of a truancy contempt of court where the right to counsel attaches. No additional credits will be given for review hearings.
 2. ARY/CHINS. ARY and CHINS cases will be counted as one credit for new assignments on a petition for ARY or CHINS. The initial case credit will include two review hearings. Review hearings after the first two on that petition will earn one third (.33) credit per review.
 3. Review hearings. All hearings subsequent to the hearing in which the ARY or CHINS fact finding is completed and in which disposition of the petition is ordered, if ordered in a separate hearing, will be considered a review. Any contempt hearing ordered on the original petition post disposition will be considered a review credit, if the matter is handled within the proceedings relating to the ARY or CHINS petition. Hearings relating to the contempt in the ARY or CHINS proceeding which occur post disposition of the contempt matter will be considered a review hearing.
 4. Truancy credit load limit. For purposes of this contract, Truancy cases will have a case credit load limit of 375 credits per FTE attorney per year.
 5. ARY / CHINS credit load limit. For purposes of this contract, ARY and CHINS cases will have a case credit load limit of 250 credits per FTE attorney per year.
 6. A variance of five percent applies to Becca cases in total, as counted in aggregate in this Contract. Site specific estimates included in Attachment B are for Agency management purposes only.
 7. The Agency agrees to provide attorneys for the same court sessions and calendars in 2008 as it did in 2007.
- I. Sexual Predator cases: The Agency shall be paid by the State of Washington for cases filed under RCW 71.09 and assigned to the Agency by OPD at a rate determined by DSHS or as ordered by the Court. Agency reimbursement shall be based on submission of expenditure reports and an invoice to DSHS in a format approved by DSHS. OPD shall apply its policies and procedures, as amended and posted on its website, to review and approve or deny requests from Agency counsel for use of Expert Services in 71.09 cases. Such authorization for Expert Services shall be made at the sole discretion of OPD. Upon approval or denial of counsel's request for Expert Services, OPD shall notify counsel. Per OPD policy, defense counsel may appeal an expert service denial to the court. Expert service reimbursement shall be invoiced to and provided directly by DSHS.
- J. Prepayments
1. The Agency shall ensure that it has sufficient funds to complete prepaid cases assigned but not completed at the end of the Contract period. The Agency must report its calculated prepayment retention amount and cost estimate, include the method of calculation, and provide a conclusion about whether the funds available would cover all costs associated with completing the cases

assigned and prepaid. Not having an adequate reserve shall not be cause for a material breach of contract, but may require Agency corrective action.

2. In the absence of a precise calculation of prepayments by the Agency, the County shall estimate the sufficiency of funds using the following formula:

For all felony, misdemeanor, initial dependency assignments, and juvenile offender cases assigned during October, November, and December that remain open at year-end, it is assumed that October cases are 75 percent completed, November cases are 50 percent completed, and December cases are 25 percent completed. For dependency cases it is assumed October cases are 15 percent completed, November cases are ten percent completed, and December cases are five percent completed.

The estimation shall be the result of calculating the number of open cases for each month by the corresponding percentage of uncompleted work, and then determining the sum of the uncompleted case count by the per case revenue amount to determine the sufficiency of funds.

V. REPORTING REQUIREMENTS

Compliance with the terms of this Exhibit requires the following reports, in a format approved by the County, to be submitted at the times indicated in the chart below.

Report Title	2008 Due Date
Closed Case Reports Persistent Offender (593) Monthly Case Report Additional Credit forms Monthly Expenditure Reports Complex Litigation time sheets Extraordinary Case Credit requests	Monthly, or more frequently if necessary
Year-end Attorney Case Assignment Report	January
Agency Disaster Plan	June
Annual Financial Statements, IRS Form 990, Audit Report including management letters.	August
Additional summaries, reports or documents, corrective actions directly related to Contract performance, as requested by OPD with reasonable notice.	Varies

ATTACHMENT A

Case Credit Application Schedule

Type of Case	
Felon	
One completed case	One case credit
Atty/Day or substantial advice	.10 case credit
Atty/Day or substantial advice in the King County Detention Facility	.20 case credit
Probation, other reviews, or sentencing only	.33 case credit
Assignment for Motion to Withdraw Guilty Plea or a Motion for New Trial based on a claim of ineffective assistance of counsel	One case credit
Murder 1	Two case credits upon assignment
Murder 2	Two case credits upon assignment
Persistent Offender (593)	<p>One case credit upon assignment, less previously assigned felony credit. The Agency is eligible for additional case credit for each additional 12.1 hours or portion thereof of attorney time on the case according to the Extraordinary Cases section of this Attachment A. The Agency shall report monthly to OPD the total attorney time in each persistent offender case in a format consistent with Attachment F categorizing attorney hours. It is understood that the Agency director or the director's designee will review the status of all pending persistent offender cases in the Agency at least monthly and will discuss the cases with the attorneys representing the clients. Such review will include the status of investigation, preparation and presentation of mitigation packages, legal and factual issues in the case, the client's physical and mental status, and any plea bargaining offers.</p> <p>This reimbursement method shall be in place until such time as the King County Council approves, by motion, a change in reimbursement methodology, and such time when the Council approved change is amended to this Contract.</p>
Felony Bench Warrant during case	One case credit if more than 180 days has passed since the date of the bench warrant and if the bench warrant was on a new case assignment; or 0.33 case credit if warrant was a probation review or other hearing valued at 0.33 credit.

Type of Case	
Case transferred to another agency, assigned counsel, or retained counsel	Substantial advice credit if case is not completed prior to transfer and if Agency provides to OPD satisfactory justification for credit. In the event that award of substantial advice credit alone results in a substantial financial hardship to the Agency, the Agency may request additional credit. Factors to be considered for additional credit include advanced stage of proceedings (e.g. set for plea, set for or approaching trial date, substantial amount of work expended).
Case transferred to drug court	One case credit
Complex Litigation	
Capital cases	Two FTE attorneys; 25 complex litigation case credits per month maximum plus support staff as approved.
Aggravated Homicide	One FTE attorney; 12.5 complex litigation case credits per month maximum.
King County Misdemeanor	
One completed case, King County District Court	One case credit
District Court review, revocation, re-sentencing or other hearing	One case credit
One District Court expedited felony	One case credit
Misdemeanor Appeal	Four case credits
Misdemeanor Writ	Three case credits
Atty/Day or substantial advice; excludes misdemeanor beeper calendar matters listed in Attachment B and other calendar representation.	0.10 case credit
Atty/Day or substantial advice for In-custody clients; excludes misdemeanor beeper calendar matters listed in Attachment B and other calendar representation.	0.20 case credit
Traffic Offense	
One completed case	One case credit
Decline hearing	One case credit

Type of Case	
Reviews	0.33 case credit
Atty/Day or substantial advice	0.10 case credit
Juvenile Dependency	
A dependency case	One case credit
Post Disposition Review Hearing	0.40 case credit
Dependency trial	0.50 case credit
Termination trial	One case credit
Atty/Day for substantial advice	0.10 case credit
Restoration of Parental Rights	
Child and/or parent may be represented	One case credit
Civil Contempt	
From show cause initial assignment hearing up to and including two contempt reviews	One case credit
Subsequent reviews	0.33 case credit
Becca Child in Need of Services At-Risk Youth Initiative	One case credit for one completed case – petition through closure.
FA	One case credit
Drug Division Court	Calendar funding
Drug Mental Health Court	Calendar funding
Other Circumstances	
New statutory mandates	Case types not contemplated by this Contract arising from legislation with effective dates after January 1, 2007 shall be assigned by OPD and accepted by the Agency subject to agreement on the credit to be given.

Type of Case	
Extraordinary Cases	<p>Extraordinary Juvenile Felony Offender, Dependency, Termination of Parental Rights, RCW 26.33.110 contested adoption termination, Reinstatement of Parental Rights, Murder, Persistent Offender, and all Adult Felony cases shall be given extra credits if the nature of the case requires such extra credits, based upon a written application from the Agency for additional credits and negotiation between OPD and the Agency. Factors entering into the awarding of extra credits include, but are not limited to: seriousness of the charges; amount and complexity of evidence; number of witnesses; unusual legal issues; number of defendants; whether there is a plea, bench trial or jury trial; number of pre-trial motions or hearings needed; severity of the consequences; and actual length of trial.</p> <p>The Agency application must be specific about the work to be done or completed to date, the estimated length of time to perform the work, and the personnel that will be assigned to perform the work. Initial OPD response to the Agency, including requests for additional information, shall be made within five business days from OPD receipt of Agency application.</p>
Credit for cases where the Agency withdraws due to a conflict of interest	<p>When the Agency has reviewed discovery and reported to OPD its withdrawal for reason of conflict and requested credit for time expended, OPD shall review the Agency's request for credit, including the reason given for withdrawal and may grant appropriate credit. Should such credit be denied, OPD shall inform the Agency of the basis for denial.</p>
Pro Se/Standby Counsel	<p>One case credit if professional support staff work is performed by the Agency and requests for appointment of professional support staff at public expense outside of the Agency are not submitted to OPD. If professional support staff work is requested by the pro se defendant, the Agency may inform OPD that it is opting to reduce its credit allocation by 0.1 per attorney credits assigned in the case by not utilizing its professional support staff.</p>

ATTACHMENT B

Agency Case Credit Allocation and Cases Assigned Estimate for January - December 2008

Case Category	Total Agency Case Credit Allocation	Agency's % of Total OPD Case Credits	1st Quarter	2nd Quarter	3rd Quarter	4th Quarter
<i>Felony & 593s</i>	2,453.0	22%	613.0	614.0	613.0	613.0
<i>Complex</i>	300.0	50%	75.0	75.0	75.0	75.0
Total Felony	2,753.0		688.0	689.0	688.0	688.0
KC Misdemeanor	2,669.0	31%	667.0	667.0	668.0	667.0
Juvenile Offender	1,228.0	31%	307.0	307.0	307.0	307.0
Dependency	1,432.0	45%	358.0	358.0	358.0	358.0
Contempt of Court	1,362.0	57%	341.0	340.0	340.0	341.0
Becca – Estimated DYS	260.6		65.0	65.0	65.0	65.6
Becca – Estimated RJC	430.9		108.0	108.0	107.5	107.4
Total Becca (new cases)	691.5	49%	173.0	173.0	172.5	173.0
TOTAL	10,135.5	30%	2,534.0	2,534.0	2,533.5	2,534.0

2008 Calendar Attorney and Staff List

Case Area	KCCF	RJC	Calendar	Agency	Day	Time	Atty	Staff	Supv
FELONY	x		Out-of-Custody SRA calendar	SCR	Fri	8-noon	0.25	0.25	0.03
		x	Felony Investigation calendar	SCR	Mon-Sat	2-5:00	0.60	0.25	0.06
		x	In-Custody SRA calendar	SCR	Fri	1-3:30	0.25	0.25	0.03
KC MISDEAMEANOR	x		Domestic Violence Court calendar	SCR	Mon-Fri	8-5:00	1.00	0.25	0.10
		x	Warrant calendar	SCR	T-Th-Sat	8:30-4:30	1.00	0.25	0.10
			NE Redmond District Court	SCR	Mon	8-noon	0.20		0.02
JUVENILE	x		1st appearance & diversion calls	SCR	Mon-Fri	1-4:00	0.50		0.05
DEPENDENCY	x		Attorney of the Day (AOD) 72-hour Shelter Care	SCR	Mon-Fri	8-noon	0.50		0.05
		x	Attorney of the Day (AOD) 72-hour Shelter Care	SCR	Mon-Fri	8-noon	0.50		0.05
SUB-TOTAL SCRAP							4.80	1.25	0.48

Beeper Duty \$11,549
 (\$30/day * 365 days)+ 2008 COLA

ATTACHMENT C

Payment Schedule

This Payment Schedule shall pertain to all cases assigned to the Agency from January 1, 2008 to December 31, 2008. In 2008, the Agency shall be paid the following monthly amounts for cases and special services:

2008	Jan Payment	Feb Payment	Mar Payment	Apr Payment	May Payment	Jun Payment
Felony (regular & 593s)	228,085	228,085	228,085	228,085	228,085	228,085
Felony (complex) ^a	27,896	27,896	27,896	27,896	27,896	27,896
Juvenile	51,096	51,096	51,096	51,096	51,096	51,096
King County Misdemeanor	81,685	81,685	81,685	81,685	81,685	81,685
Dependency	110,744	110,744	110,744	110,744	110,744	110,744
Contempt of Court	80,098	80,098	80,098	80,098	80,098	80,098
Calendar Staffing	55,420	55,420	55,420	55,420	55,420	55,420
Agency Admin & Overhead:						
Administration	51,279	51,279	51,279	51,279	51,279	51,279
Indirect Cost	29,917	29,917	29,917	29,917	29,917	29,917
Rent	54,615	54,615	54,615	54,615	54,615	54,615
Total Agency Admin & Overhead	135,811	135,811	135,811	135,811	135,811	135,811
Becca	29,712	29,712	29,712	29,712	29,712	29,712
Juvenile 10.101 ^c	17,742	17,742	17,742	17,742	17,742	17,742
Juvenile Drug Court	1,270	1,270	1,270	1,270	1,270	1,270
SCRAP TOTAL	819,559	819,559	819,559	819,559	819,559	819,559

2008	Jul Payment	Aug Payment	Sep Payment	Oct Payment	Nov Payment	Dec Payment	TOTAL Jan-Dec 2008
Felony (regular & 593s)	228,085	228,085	228,085	228,085	228,085	228,106	2,737,041
Felony (complex) ^a	27,896	27,896	27,896	27,896	27,896	27,882	334,738^b
Juvenile	51,096	51,096	51,096	51,096	51,096	51,119	613,175
King County Misdemeanor	81,685	81,685	81,685	81,685	81,685	81,689	980,224
Dependency	110,744	110,744	110,744	110,744	110,744	110,747	1,328,931
Contempt of Court	80,098	80,098	80,098	80,098	80,098	80,090	961,168
Calendar Staffing	55,420	55,420	55,420	55,420	55,420	55,434	665,054
Agency Admin & Overhead:							
Administration	51,279	51,279	51,279	51,279	51,279	51,282	615,351
Indirect Cost	29,917	29,917	29,917	29,917	29,917	29,919	359,006
Rent	54,615	54,615	54,615	54,615	54,615	54,619	655,384
Total Agency Admin & Overhead	135,811	135,811	135,811	135,811	135,811	135,820	1,629,741
Becca	29,712	29,712	29,712	29,712	29,712	29,708.50	356,540.50
Juvenile 10.101 ^c	17,742	17,742	17,742	17,742	17,742	17,743	212,905
Juvenile Drug Court	1,270	1,270	1,270	1,270	1,270	1,270	15,240
SCRAP TOTAL	819,559	819,559	819,559	819,559	819,559	819,609	9,834,757.50

^a Payment is made on a per credit basis for cases open during the month.

^b This total amount is estimated in consideration of cases open at the beginning of the contract. The actual annual amount may be greater or lesser depending upon new case assignments and the timing of case closing for existing cases.

^c Public Defense Improvement Fund from the Washington State Office of Public Defense.

ATTACHMENT E

NOTIFICATION OF WITHDRAWAL

PLEASE PRINT OR TYPE

Date: _____

Client Name: _____ AKA: _____

Address: _____ Phone: _____

DOB: _____ JCN: _____ CCN: _____

Cause Number: _____ Charge: _____

Case Type: Felony Seattle Municipal Juvenile
 Dependency Civil Contempt KC Misdemeanor
 ITA Other _____

REASON FOR WITHDRAWAL:

Conflict of Interest Other _____

Defendant Retained Private Counsel: **(Name of Attorney)** _____

CONFLICT INFORMATION:

This Agency's conflict is with: Name _____ DOB: _____

Cause Number: _____ Co-Defendant in Current Case? Yes No

Victim/Client Suspect/Client Witness/Client Other _____

OTHER NAMES IN DISCOVERY:

NAMES	DOB	STATUS IN CASE	REPRESENTATION HISTORY

SEE ATTACHED SHEET FOR ADDITIONAL LISTINGS

In-Custody Out-of-Custody Received Conflict From: _____

HEARING SCHEDULE:

Trial Date: _____ Next Hearing: _____ Type of Hearing: _____

*Withdrawal Hearing Date: _____

***(MUST BE TWO FULL WORKING DAYS FROM IDENTIFICATION OF CONFLICT IF TRIAL DATE HAS BEEN SET. AGENCY MUST NOTIFY PA AND CO-DEFENDANT COUNSEL.)**

LOCATION OF DISCOVERY:

PA's Office Agency will forward to new counsel Other _____

Request for credit/debit: _____

This form filled out by: _____ Date: _____

APPROVED BY: _____ Date: _____

OPD USE ONLY

OPD REASSIGNED TO: _____ INITIALS: _____ DATE: _____

FAX Interoffice Mail

ATTACHMENT F

[Agency] Persistent Offender (593) Monthly Case Report

Client Name: _____
 Cause No.: _____
 Month/Year: _____
 Attorney(s): _____

Week (Dates)	Attorney (1)	Attorney (2) (If assigned)	Total Atty.	Invest	Social Wkr.	Paralegal	Total Support	Total Week	Total to Date
/ to /									
/ to /									
/ to /									
/ to /									
/ to /									
TOTAL									

NOTE: 12.1 hours = 1.00 credit

Abbreviations must be used to categorize attorney hours:

- CC = Contact with Client
- R = Legal Research
- Ptr = Pretrial Hearing
- Tr = Trial
- S = Sentencing/Disposition
- CP = Case Prep
- C = Confer with attorney/investigator/social worker/paralegal
- N/A = No second attorney assigned

16404

Attachment D

King County Contract No. D37887D
Federal Taxpayer ID No. 91-0852323

Department/Division Community and Human Services/Office of the Public Defender
Agency The Defender Association
Project Title Public Defense Legal Services
Contract Amount \$9,484,897 Fund Code 00000010
Contract Period From: January 1, 2008 To December 31, 2008

KING COUNTY AGENCY SERVICES CONTRACT – 2008

THIS CONTRACT is entered into by KING COUNTY (the "County"), and The Defender Association, whose address is 810 Third Avenue, Suite 800, Seattle, WA 98104, (the "Agency").

WHEREAS, the County desires to have legal services, as described in the Contract, performed for indigent persons legally entitled to appointed counsel in King County courts and as authorized by Ordinance No. 15652; and

WHEREAS, the Agency is a nonprofit law firm, incorporated under the Washington Nonprofit Corporation Code, within the meaning of Section 501(c)(3) of the Internal Revenue Code, organized and operated exclusively for the purpose of providing court-appointed legal services to indigent persons; and

WHEREAS, the County and the Agency agree that these legal services are provided by an independent contractor non-profit corporation, possessing all of the rights, duties and obligations that are possessed under Washington State law and applicable Federal laws for an independent contractor service provider; and

WHEREAS, the County and the Agency agree that any and all funds provided pursuant to this Contract are provided for the sole purpose of provision of legal services to indigent persons assigned to the Agency by the County Office of The Public Defender (OPD) or the courts of King County.

NOW THEREFORE, in consideration of payments, covenants, and agreements hereinafter mentioned, to be made and performed by the parties hereto, the parties covenant and do mutually agree as follows:

I. SCOPE OF SERVICES

The Agency shall provide services and comply with the requirements set forth hereinafter and in the following attached exhibits, which are incorporated herein by reference:

This form is available in alternate formats for people with disabilities upon request.

- | | | |
|-------------------------------------|--|--------------------------------|
| <input checked="" type="checkbox"/> | <u>Certificate of Insurance/Endorsements</u> | Attached hereto as Exhibit I |
| <input checked="" type="checkbox"/> | <u>Personnel Inventory Report</u> | Attached hereto as Exhibit II |
| <input checked="" type="checkbox"/> | <u>Affidavit of Compliance</u> | Attached hereto as Exhibit III |
| <input checked="" type="checkbox"/> | <u>504/ADA Assurance of Compliance</u> | Attached hereto as Exhibit IV |
| <input checked="" type="checkbox"/> | <u>Public Defense Legal Services</u> | Attached hereto as Exhibit V |

II. DURATION OF CONTRACT

This Contract shall commence on the 1st day of January 2008, and shall terminate on the 31st day of December 2008 ("Contract Term"), unless terminated earlier, pursuant to the terms and conditions of the Contract. This Contract may be extended by agreement of the parties for a period of up to three months in order to complete negotiations and/or receive necessary approval of a subsequent year contract. An amendment to extend the contract duration may reflect adjustments to payment and casework schedule reflective of planned changes for subsequent year.

III. COMPENSATION AND METHOD OF PAYMENT

- A. The County shall pay the Agency for satisfactory performance of the services and requirements specified in this Contract, payable in the following manner:

As defined in Exhibit V, Section IV, for Public Defense Legal Services.

- B. The Agency shall submit all outstanding reports within 20 days of the date this Contract terminates. If any of the Agency's reports which are due to the County are not submitted by the day specified in this subsection, the County may withhold payment to the Agency until such time as reports are submitted and approved.

IV. OPERATING BUDGET

The funds provided by the County to the Agency pursuant to the terms of this Contract are solely for expenses that are directly and legitimately related to the performance of the provisions of this Contract. In the event the County, determines that funds paid pursuant to this Contract were expended for any purposes other than those set forth in this Contract, such expenditure shall constitute a material breach of this Contract. Income and expenses, including prorated overhead costs, for Sexually Violent Predator cases and any other services funded by the State DSHS shall be reported and traceable in a method consistent with accounting standards noted below. If the Agency receives any revenue from any other source, the costs paid, including prorated overhead, for work done with that revenue shall be reported and traceable according to the accounting standards noted below.

V. INTERNAL CONTROL AND ACCOUNTING SYSTEM

The Agency shall establish and maintain a system of accounting and internal controls that comply with generally accepted accounting principles and financial reporting standards applicable to publicly supported not-for-profit corporations as prescribed by the Financial Accounting Standards Board.

VI. MAINTENANCE OF RECORDS

- A. The Agency shall maintain accounts and records, including personnel, property, financial, and programmatic records and other such records as may be deemed necessary by the County to ensure proper accounting for all Contract funds and compliance with this Contract.
- B. These records shall be maintained for a period of six years after termination hereof unless permission to destroy them is granted by the Office of the Archivist in accordance with Revised Code of Washington (RCW) Chapter 40.14.
- C. The Agency shall inform the County in writing of the location, if different from the Agency address listed on page one of this Contract, of the aforesaid books, records, documents and other evidence and shall notify the County in writing of any changes in location within ten working days of any such relocation.

VII. AUDITS

- A. The Agency shall have an independent audit, conducted by a certified public accountant, of its financial statement and condition, which shall comply with generally accepted auditing standards for not-for-profit organizations as prescribed by the American Institute of Certified Public Accountants. The independent auditor's report shall include a management letter listing any reportable conditions or internal control weaknesses, or stating that no reportable conditions or control weaknesses were noted. The auditor's report shall include a copy of the Agency's management representation letter. Any independent auditor hired by the Agency to fulfill the Contract audit requirements must agree to provide access to audit working papers if requested by the County.
- B. The Agency shall provide a copy of the audit report to each County division providing financial assistance to the Agency no later than the last business day of August. The Agency fiscal year shall be the same as a calendar year. The Agency shall provide to the County its response and corrective action plan for all findings and reportable conditions contained in its audit. The Agency shall provide the County with a copy of its IRS Form 990 (Return of Organization Exempt from Tax) when it is filed with the IRS.
- C. The Agency's annual financial statements shall be prepared recognizing all Agency fund accounts at the end of the Contract Term.
- D. Any and all accounts must be invested in a fiscally prudent fashion under the non-profit corporation law of Washington and applicable Federal laws. Prepayments, as noted in Exhibit V, Section IV, J shall be invested in a cash equivalent account, defined as a highly liquid, short term investment with little risk of loss in value.
- E. Additional federal and/or state audit or review requirements may be imposed on the County, and to the extent that such requirements relate to funding that is passed on to the Agency, the Agency shall be required to comply with any such requirements. The County shall notify the Agency when requirements from funders are issued to the County.

VIII. EVALUATIONS AND INSPECTIONS

- A. Upon reasonable notice, the Agency shall provide right of access to its facilities, including those of any subcontractor, to the County, the state, and/or federal agencies

or officials at all reasonable times for the purpose of monitoring and evaluating the services provided under this Contract. The County shall give advance notice to the Agency in the case of fiscal audits to be conducted by the County.

- B. The records and documents with respect to all matters covered by this Contract, not including entire individual personnel files but may include specific requested documentation, shall be subject to inspection, review, or audit by the County (and to the extent Contract funds paid by the County are derived from federal and/or state sources, also by federal and/or state officials so authorized by law) during the Contract Term and six years thereafter, unless a longer record retention period is required by law and in such case, the right of inspection shall extend until the end of the applicable retention period.
- C. The Agency agrees to cooperate with the County or its agent in the evaluation of the Agency's performance under this Contract and to make available all information reasonably required by any such evaluation process or ongoing reporting requirements established by the County. The results and records of said evaluations and reports shall be maintained and disclosed in accordance with RCW Chapter 42.17.

IX. CORRECTIVE ACTION

The County and Agency agree that when operational or performance issues arise in the course of providing the services of this Contract, a resolution of an issue or concern will be attempted at the lowest administrative level possible, although generally contact with the Agency shall include the managing director.

If the County determines that a performance concern has not been rectified at a less formal level and/or that a breach of contract has occurred, that is, the Agency has failed to comply with any terms or conditions of this Contract or the Agency has failed to provide in any manner the work or services agreed to herein, and if the County deems said breach to warrant written corrective action, the following sequential procedure shall apply:

- A. The County shall notify the Agency in writing of the nature of the breach;

The Agency shall respond in writing within three working days of its receipt of such notification, which response shall indicate the steps being taken to correct the specified deficiencies. The corrective action plan shall specify the proposed completion date for bringing the Agency into Contract compliance, which date shall not be more than 30 days from the date of the County's approval of the Agency's plan, unless the County, at its sole discretion, specifies in writing an extension in the number of days to complete the corrective actions;
- B. The County shall notify the Agency in writing of the County's determination as to the sufficiency of the Agency's corrective action plan within ten days of receipt, or longer with written notification to the Agency. The determination of sufficiency of the Agency's corrective action plan shall be at the sole discretion of the County, provided that the County shall take into consideration the reasonableness of the proposed corrective action in light of the breach;
- C. In the event that the Agency does not respond within the appropriate time with a corrective action plan, or the Agency's corrective action plan is determined by the County to be insufficient, the County may commence termination of this Contract in whole or in part pursuant to Section XI.A. if the breach is material;

- D. In addition to and not in lieu of any of its other contractual or legal rights or remedies, the County, in its sole discretion, may withhold any payment owed the Agency hereunder or prohibit the Agency from incurring additional financial obligations, except to the extent such obligations are required by court order or deemed by the County as necessary for the competent and adequate representation of indigent persons assigned to the Agency, until the County is satisfied that corrective action has been taken or completed; and
- E. The County may choose to use corrective action in response to any type of breach by the Agency. The choice of corrective action or termination under Section XI for a material breach is within the County's sole discretion. Nothing herein shall be deemed to affect or waive any rights the parties may have pursuant to Section XI. Nor shall the exercise of any right within this section be deemed to be a breach of this Contract by the County.

X. ASSIGNMENT/SUBCONTRACTING

- A. The Agency shall not assign or subcontract any portion of the Legal Services, as defined in Exhibit V, supervision or training which is provided under this Contract or transfer or assign any claim arising pursuant to this Contract without the written consent of the County. Said consent must be sought in writing by the Agency not less than 15 days prior to the date of any proposed assignment. The definition of training, within this subsection only, does not include CLE's. The Agency may contract for training services up to a cumulative amount of \$10,000.00 in a contract year, without seeking consent of the County. These excluded contracts and CLE costs must be reported to the County, as noted in Paragraph X. B. of this Section.
- B. The Agency shall keep all records of any contracts or purchases of goods or services related to this Contract. The Agency shall be required to report these expenditures to the County and the original records may be subject to audit at the County's request.

XI. TERMINATION

- A. The County may terminate this Contract, in whole or in part, upon seven days advance written notice in the event: (1) the Agency breaches any material duty, obligation, or service required pursuant to this Contract, (2) the Agency or any of its officers, directors, employees, subcontractors, agents or representatives engages in the misappropriation or mismanagement of Contract funds or the fraudulent disbursement of Contract funds, (3) the Agency or any of its officers, directors, agents, representatives or designees makes a material misrepresentation regarding the Agency, its finances and/or scope of activities to its independent accountant, auditor, the County, and/or any other agencies or instrumentalities of the federal, state or local government or commits any act or omission that jeopardizes the Agency's tax-exempt status under Code section 501(c)(3) or (4) the duties, obligations, or services required herein become impossible, illegal, or not feasible. The County's termination notice does not bar the Agency from seeking injunctive relief or any other equitable relief available under current Washington State law.

If the Contract is terminated by the County pursuant to (1), (2), or (3) in the first paragraph of XI. A., the Agency shall be liable for damages, including any additional reasonable costs of procurement of similar services from another source.

In the event the County terminates the Contract due to (1), (2), or (3) in the first paragraph of XI. A., or any act or omission which jeopardizes the Agency's tax-exempt

status under IRS Code Section 501(c)(3), then subject to the provisions of this Section, the Agency shall return to the County any funds misappropriated and paid to the Agency by the County under the current Contract and from any available source, including funds from a prior contract. In addition, the Agency shall return such funds determined by the County to be reasonable and necessary to provide legal services, as defined in Exhibit V, for the balance of the Contract term, or until the County is able to obtain a successor agency to provide such services, whichever period is less. This provision and the obligations contained herein shall survive the termination or expiration of this Contract.

The Agency may terminate this Contract, in whole or in part, prior to the end of the Contract Term, by providing the County seven days advance written notice, in the event the County commits any material breach of this Contract caused by non-payment or partial termination of caseload area or geographic location of services by the County without a negotiated amendment.

- B. In the event of the termination of this Contract the Agency shall remit any unexpended balance of funds paid, including prepaid funds for cases assigned and not completed, less the amount the County and the Agency agree shall be necessary to enable the Agency to deliver services in those cases notwithstanding the termination. Nothing herein shall limit, waive, or extinguish any right or remedy provided by this Contract or law that either party may have in the event that the obligations, terms, and conditions set forth in this Contract are breached by the other party.
- C. If County expected or actual funding is withdrawn, reduced, or limited in any way prior to the termination date set forth above in Section II, the County may, upon 15 days written notification to the Agency, terminate this Contract in whole or in part.

If the Contract is terminated as provided in this Subsection: (1) the County shall be liable only for payment in accordance with the terms of this Contract for services rendered prior to the effective date of termination; and (2) the Agency shall be released from any obligation to provide such further services pursuant to the Contract as are affected by the termination.

- D. This Contract may be terminated for convenience by either party, prior to the date specified in Section II, by providing 60 days advance written notice of the termination.

XII. DISPUTE RESOLUTION

Agency disputes pertaining to County decisions regarding Contract compliance issues shall be made in writing to The Public Defender. The written dispute shall include the decision being questioned and the point on which the dispute is made. This is a non-exclusive remedy.

The Public Defender shall make a determination decision and respond in writing to the Agency within 15 days of receipt. If the Agency wishes to appeal The Public Defender decision, an additional letter indicating all points of the dispute resolution process to date shall be sent to the Director of the Department of Community and Human Services. The Department Director shall make a final determination and respond in writing to the Agency within 30 days of the Department Director's Office receipt of the appeal notice from the Agency.

Nothing herein shall impair the procedure of Section IX above nor the ability of either party to terminate this Contract as set forth in Section XI above.

XIII. FUTURE SUPPORT

- A. The County makes no assurance or commitment to the Agency for a subsequent contract or extension of the effective dates of the Contract for the services contracted for herein. Funding or obligation under this Contract beyond the current appropriation year is conditional upon appropriation by the County Council of sufficient funds to support the activities described in the Contract. Should such appropriation not be approved, this Contract shall terminate at the close of the current appropriation year.
- B. Should the County or Agency terminate this Contract or not renew this Contract for services in a subsequent period, the County shall work with the Agency to provide appropriate transition planning for assigned Agency clients to ensure their defense is not jeopardized by actions of the Agency or the County.

XIV. HOLD HARMLESS AND INDEMNIFICATION

- A. In providing services under this Contract, the Agency is an independent contractor, and neither it nor any of its officers, directors, employees, subcontractors, agents, or representatives are employees of the County for any purpose. The Agency shall be responsible for all federal and/or state tax, industrial insurance, and Social Security liability that may result from the performance of and compensation for these services and shall make no claim of career service or civil service rights which may accrue to a County employee under state or local law.

The County assumes no responsibility for the payment of any compensation, wages, benefits, or taxes, by, or on behalf of the Agency, its employees, and/or others by reason of this Contract. The Agency shall protect, indemnify, and save harmless the County, its officers, officials, agents, and employees from and against any and all claims, costs, and/or losses whatsoever occurring or resulting from (1) the Agency's failure to pay any such compensation, wages, benefits, or taxes, and/or (2) the supplying to the Agency of work, services, materials, or supplies by Agency employees or other suppliers in connection with or support of the performance of this Contract.

- B. The Agency further agrees that it is financially responsible for and shall repay the County all amounts determined by a fiscal audit exception which occur due to the negligence, intentional act, and/or failure, for any reason, to comply with the terms of this Contract by the Agency, its officers, directors, employees, subcontractors, agents, and/or representatives.
- C. Should it become necessary to institute legal action in order to recoup any funds due and owing to the County or the Agency pursuant to any of the terms of this Contract, the non-prevailing party agrees it is financially responsible and liable for the prevailing attorneys' fees and costs. Each party's duty to repay shall not be diminished or extinguished by the prior termination of the Contract pursuant to any provision hereof.
- D. The Agency shall protect, defend, indemnify, and save harmless the County, its officers, officials, employees, and agents from any and all costs, claims, judgments, and/or awards of damages, arising out of, or in any way resulting from, the negligent acts or omissions of the Agency, its officers, directors, employees, subcontractors, agents, and/or representatives in performance and/or non-performance of its obligations under this Contract. The Agency agrees that its obligations under this subparagraph extend to any claim, demand, and/or cause of action brought by, or on behalf of, any of its employees or agents. For this purpose, the Agency, by mutual

negotiation, hereby waives, as respects the County only, any immunity that would otherwise be available against such claims under the Industrial Insurance provisions of Title 51 RCW. In the event the County incurs any judgment, award, and/or cost arising therefrom including attorneys' fees to enforce the provisions of this article, all such fees, expenses, and costs shall be recoverable from the Agency.

- E. The County shall protect, defend, indemnify, and hold harmless the Agency, its officers, directors, employees, agents, and representatives from any and all costs, claims, judgments, and/or awards of damages, arising out of, or in any way resulting from, the negligent acts or omissions of the County, its officers, officials, employees, or agents. The County agrees that its obligations under this subparagraph extends to any claim, demand, and/or cause of action brought by, or on behalf of, any of its employees or agents. For this purpose, the County, by mutual negotiation, hereby waives, as respects the Agency only, any immunity that would otherwise be available against such claims under the Industrial Insurance provisions of Title 51 RCW. In the event the Agency incurs any judgment, award, and/or cost arising therefrom including attorneys' fees to enforce the provisions of this article, all such fees, expenses, and costs shall be recoverable from the County.

Claims shall include, but not be limited to, assertions that the use or transfer of software, book, document, report, film, tape, or sound reproduction or material of any kind, delivered hereunder, constitutes an infringement of any copyright, patent, trademark, trade name, and/or otherwise results in unfair trade practice.

- F. To the extent that an Agency subcontractor fails to satisfy its obligation to defend and indemnify the County as detailed in Section XVIII.B. of this Contract, the Agency shall protect, defend, indemnify, and hold harmless the County, its officers, employees and agents from any and all costs, claims, judgments, and/or awards or damages arising out of, or in any way resulting from, the negligent act or omissions of the Agency's subcontractor, its officers, employees, and/or agents in connection with or in support of this Contract.
- G. Nothing contained within this provision shall affect and/or alter the application of any other provision contained within this Contract.

XV. INSURANCE REQUIREMENTS

- A. By the date of execution of this Contract, the Agency shall procure and maintain for the duration of this Contract, insurance against claims for injuries to persons or damages to property which may arise from, or is in connection with, the performance of work hereunder by the Agency, its agents, representatives, employees, and/or subcontractors. The costs of such insurance shall be paid by the Agency or subcontractor. The Agency must furnish separate certificates of insurance and policy endorsements for each subcontractor as evidence of compliance with the insurance requirements of this Contract. The Agency is responsible for ensuring compliance with all of the insurance requirements stated herein. Failure by the Agency, its agents, employees, officers, and or subcontractors, to comply with the insurance requirements stated herein shall constitute a material breach of this Contract.

For All Coverages: Each insurance policy shall be written on an "occurrence" form; except that insurance on a "claims made" form may be acceptable with prior County approval.

If coverage is approved and purchased on a "claims made" basis, the Agency warrants continuation of coverage, either through policy renewals or the purchase of an extended discovery period, if such extended coverage is available, for not less than three years from the date of Contract termination, and/or conversion from a "claims made" form to an "occurrence" coverage form.

By requiring such minimum insurance, the County shall not be deemed or construed to have assessed the risks that may be applicable to the Agency under this Contract. The Agency shall assess its own risks and, if it deems appropriate and/or prudent, maintain greater limits and/or broader coverage.

Nothing contained within these insurance requirements shall be deemed to limit the scope, application and/or limits of the coverage afforded by said policies, which coverage shall apply to each insured to the full extent provided by the terms and conditions of the policy(s). Nothing contained within this provision shall affect and/or alter the application of any other provision contained within this Contract.

B. Minimum Scope of Insurance

Coverage shall be at least as broad as:

1. General Liability:

Insurance Services Office form number (CG 00 01 Ed. 11-88) covering **COMMERCIAL GENERAL LIABILITY**.

2. Professional Liability:

Professional Liability, Errors, and Omissions coverage. In the event that services delivered pursuant to this Contract either directly or indirectly involve or require professional services, Professional Liability, Errors, and Omissions coverage shall be provided. "Professional Services", for the purpose of this Contract section, shall mean any services provided by a licensed professional or those services that require a professional standard of care.

3. Automobile Liability:

In the event that services delivered pursuant to this Contract require the use of a vehicle or involve the transportation of clients by Agency personnel in Agency-owned vehicles or non-owned vehicles, the Agency shall provide evidence of the appropriate automobile coverage.

Insurance Services Office form number (CA 00 01 Ed. 12-90) covering **BUSINESS AUTO COVERAGE**, symbol 1 "any auto"; or the appropriate coverage provided by symbols 2, 7, 8, or 9.

4. Workers' Compensation:

Workers' Compensation coverage, as required by the Industrial Insurance Act of the State of Washington, as well as any similar coverage required for this work by applicable federal or "Other States" state law.

5. Stop Gap/Employers Liability:

Coverage shall be at least as broad as the protection provided by the Workers' Compensation policy Part 2 (Employers Liability) or, in states with monopolistic state funds, the protection provided by the "Stop Gap" endorsement to the general liability policy.

C. Minimum Limits of Insurance

The Agency shall maintain limits no less than, for:

1. General Liability: \$1,000,000 combined single limit per occurrence by bodily injury, personal injury, and property damage, and for those policies with aggregate limits, a \$2,000,000 aggregate limit.
2. Professional Liability, Errors, and Omissions: \$2,000,000 per claim and in the aggregate.
3. Automobile Liability: \$1,000,000 combined single limit per accident for bodily injury and property damage. Except if the transport of clients by Agency personnel is involved, then Risk Management shall review the appropriate amount of coverage.
4. Workers' Compensation: Statutory requirements of the state of residency.
5. Stop Gap/Employers Liability: \$1,000,000.

D. Deductibles and/or Self-insured Retentions

Any deductibles or self-insured retentions greater than \$10,000 must be declared to, and approved by, the County. The deductible and/or self-insured retention of the policies shall not apply to the Agency's liability to the County and shall be the sole responsibility of the Agency.

E. Other Insurance Provisions

The insurance policies required in this Contract are to contain, or be endorsed to contain, the following provisions:

1. Liability Policies Except Professional and Workers Compensation
 - a. The County, its officers, officials, employees, and agents are to be covered as additional insureds as respects liability arising out of activities performed by or on behalf of the Agency in connection with this Contract.
 - b. The Agency's insurance coverage shall be primary insurance as respects the County, its officers, officials, employees, and agents. Any insurance and/or self-insurance maintained by the County, its offices, officials, employees, or agents shall not contribute with the Agency's insurance or benefit the Agency in any way.
 - c. The Agency's insurance shall apply separately to each insured against whom claim is made and/or lawsuit is brought, except with respect to the limits of the insurer's liability.

2. All Policies

Coverage shall not be suspended, voided, canceled, reduced in coverage or in limits, except by the reduction of the applicable aggregate limit by claims paid, until after 45 days prior written notice has been given to the County.

F. Acceptability of Insurers

Unless otherwise approved by the County,

Insurance is to be placed with insurers with a Bests' rating of no less than A:VIII, or, if not rated with Bests, with minimum surpluses the equivalent of Bests' surplus size VIII.

Professional Liability, Errors, and Omissions insurance may be placed with insurers with a Bests' rating of B+VII. Any exception must be approved by King County.

If, at any time, the foregoing policies shall fail to meet the above minimum requirements the Agency shall, upon notice to that effect from the County, promptly obtain a new policy, and shall submit the same to the County, with appropriate certificates and endorsements, for approval.

G. Verification of Coverage

The Agency shall furnish the County certificates of insurance and endorsements required by this Contract. Such certificates and endorsements, and renewals thereof, shall be attached as exhibits to the Contract. The certificates and endorsements for each insurance policy are to be signed by a person authorized by that insurer to bind coverage on its behalf. The certificates and endorsements for each insurance policy are to be on forms approved by the County prior to the commencement of activities associated with the Contract. The County reserves the right to require complete, certified copies of all required insurance policies at any time.

H. Subcontractors

The Agency shall include all subcontractors as insureds under its policies or shall furnish separate certificates of insurance and policy endorsements from each subcontractor. Insurance coverages provided by subcontractors as evidence of compliance with the insurance requirements of this Contract shall be subject to all of the requirements stated herein.

XVI. NONDISCRIMINATION AND EQUAL EMPLOYMENT OPPORTUNITY

A. Nondiscrimination in Employment Provision of Services

During the Contract Term, neither the Agency nor any party subcontracting under the authority of this Contract shall discriminate or tolerate harassment on the basis of race, color, sex, religion, national origin, marital status, sexual orientation, age, or the presence of any sensory, mental, or physical disability in the employment or application for employment or in the administration or delivery of services or any other benefits under this Contract.

B. Equal Benefits to Employees with Domestic Partners

Pursuant to Ordinance 14823, King County's "Equal Benefits" (EB) ordinance, and related administrative rules adopted by the County Executive, as a condition of award of a contract valued at \$25,000 or more, the Contractor agrees that it shall not discriminate in the provision of employee benefits between employees with spouses, and employees with domestic partners during the performance of this Contract. Failure to comply with this provision shall be considered a material breach of this Contract, and may subject the Contractor to administrative sanctions and remedies for breach.

When the contract is valued at \$25,000 or more, the Contractor shall complete a Worksheet and Declaration form for County review and acceptance prior to Contract execution. The EB Compliance forms, Ordinance 14823 (which is codified at KCC Chapter 12.19), and related administrative rules are incorporated herein by reference. They are also available online at:
<http://www.metrokc.gov/procurement/services/eb.aspx>

C. Nondiscrimination in Subcontracting Practices

During the solicitation, award and term of this Contract, the Agency shall not create barriers to open and fair opportunities to participate in County contracts or to obtain or compete for contracts and subcontracts as sources of supplies, equipment, construction and services. In considering offers from and doing business with subcontractors and suppliers, the Agency shall not discriminate against any person on the basis of race, color, religion, sex, age, national origin, marital status, sexual orientation or the presence of any mental or physical disability in an otherwise qualified disabled person.

D. Compliance with Laws and Regulations

The Agency shall comply fully with all applicable federal, state and local laws, ordinances, executive orders and regulations that prohibit discrimination. These laws include, but are not limited to, KCC 12.17, RCW Chapter 49.60, Titles VI and VII of the Civil Rights Act of 1964, 42 U.S.C. 2000(a) et seq., the Americans with Disabilities Act, 42 U.S.C. 12101 et seq., and the Restoration Act of 1987. The Agency shall further comply fully with any affirmative action requirements set forth in any federal regulations, statutes or rules included or referenced in the Contract.

E. Small Business and Minority and Women Business Enterprise Opportunities

The County encourages the Agency to utilize small businesses, including Minority-owned and Women-owned Business Enterprises ("M/WBEs") in County contracts. The County encourages the Agency to use the following voluntary practices to promote open competitive opportunities for small businesses, including M/WBEs:

1. Attending a pre-bid or pre-solicitation conference, if scheduled by the County, to provide project information and to inform small businesses and other firms of contracting and subcontracting opportunities;
2. Placing all qualified small businesses, attempting to do business in King County, including M/WBEs, on solicitation lists, and providing written notice of subcontracting opportunities to these firms capable of performing the work, including without limitation all businesses on any list provided by the County, in sufficient time to allow such businesses to respond to the written solicitations;

3. Breaking down total requirements into smaller tasks or quantities, where economically feasible, in order to permit maximum participation by small businesses, including M/WBEs;
4. Establishing delivery schedules, where the requirements of this Contract permit, that encourage participation by small businesses, including M/WBEs;
5. Providing small businesses, including M/WBEs that express interest with adequate and timely information about plans, specifications, and requirements of the Contract;
6. Using the services of available community organizations, contractor groups, local assistance offices, the County, and other organizations that provide assistance in the recruitment and placement of small businesses, including M/WBEs; and,
7. The Washington State Office of Minority and Women's Business Enterprises (OMWBE) can provide a list of certified M/WBEs. Contact OMWBE office at 360-753-9693 or on-line through the web site at www.wsdot.wa.gov/omwbe/.

F. Equal Employment Opportunity

The Agency shall implement and carry out the obligations in its Affidavit and Certificate of Compliance regarding equal employment opportunity, and all other requirements as set forth in the Affidavit and Certificate of Compliance.

G. Fair Employment Practices

King County Code Chapter 12.18 is incorporated by reference as if fully set forth herein and such requirements apply to this Contract. During the performance of this Contract, neither the Agency nor any party subcontracting under the authority of this Contract shall engage in unfair employment practices. It is an unfair employment practice for any:

1. Employer or labor organization to discriminate against any person with respect to referral, hiring, tenure, promotion, terms, conditions, wages or other privileges of employment;
2. Employment agency or labor organization to discriminate against any person with respect to membership rights and privileges, admission to or participation in any guidance program, apprenticeship training program, or other occupational training program;
3. Employers, employment agency, or labor organization to print, circulate, or cause to be printed, published or circulated, any statement, advertisement, or publication relating to employment or membership, or to use any form of application therefore, which indicates any discrimination unless based upon a bona fide occupation qualification;
4. Employment agency to discriminate against any person with respect to any reference for employment or assignment to a particular job classification;
5. Employer, employment agency or a labor organization to retaliate against any person because that person has opposed any practice forbidden by KCC

Chapter 12.18 or because that person has made a charge, testified or assisted in any manner in any investigation, proceeding or hearing initiated under the provisions of KCC Chapter 12.18;

6. Publisher, firm, corporation, organization or association printing, publishing or circulating any newspaper, magazine or other written publication to print or cause to be printed or circulated any advertisement with knowledge that the same is in violation of KCC Chapter 12.18.030.C., or to segregate and separately designate advertisements as applying only to men or women unless such discrimination is reasonably necessary to the normal operation of the particular business, enterprise or employment, unless based upon a bona fide occupational qualification;
7. Employer to prohibit any person from speaking in a language other than English in the workplace unless:
 - a. The employer can show that requiring that employees speak English at certain times is justified by business necessity, and
 - b. The employer informs employees of the requirement and the consequences of violating the rule.
8. If the Agency engages in unfair employment practices as defined above, remedies as set forth in KCC Chapter 12.18 may be applied.

H. Record-Keeping Requirements and Site Visits

The Agency shall maintain, for at least six years after completion of all work under this Contract, the following:

1. Records of employment, employment advertisements, application forms, and other pertinent data, records and information related to employment, and solicited applications for employment; and
2. Records, including written quotes, bids, estimates or proposals submitted to the Agency by all businesses responding to Agency solicitation, and any other information necessary to document the actual use of and payments to subcontractors and suppliers in this Contract, including employment records.

The County may visit upon reasonable notice, at any reasonable time, the site of the work and the Agency's office to review the foregoing records. The Agency shall provide every assistance requested by the County during such visits. In all other respects, the Agency shall make the foregoing records available to the County for inspection and copying any reasonable volume of documents upon request. If this Contract involves federal funds, the Agency shall comply with all record keeping requirements set forth in any federal rules, regulations or statutes included or referenced in this Contract and the Exhibits attached.

I. Sanctions for Violations

Any violation of the mandatory requirements of the provisions of this Section shall be a material breach of this Contract for which the Agency may be subject to damages, withhold of payment and any other sanctions provided for by this Contract and by applicable law.

J. Reporting

1. The Agency shall submit with this Contract a total Personnel Inventory Report providing employment data for minorities, females, and persons with disabilities.

Subject to the provisions of KCC Chapter 12.16.060, the Agency's Personnel Inventory Report shall be effective for two years after the date on which the report was submitted.

2. The Agency also shall submit an Affidavit of Compliance in the form provided by the County, demonstrating commitment to comply with the provisions of KCC Chapter 12.16 in accordance with Paragraph A of this Section.

The Agency shall complete the Affidavit of Compliance provided by the County and attach the original, notarized, completed form to this Contract. Subject to the provisions of KCC Chapter 12.16.060, the Agency's Affidavit of Compliance shall be effective for two years after the date on which the report was submitted.

If the Agency engages in unfair employment practices as defined above, remedies as set forth in KCC Chapter 12.18 shall be applied as well as any other remedies by law.

The Agency shall complete all reports and forms (including Department of Social and Health Services non-discrimination forms, where applicable) provided by the County and shall otherwise cooperate fully with the County in monitoring and assisting the Agency in providing nondiscriminatory programs.

XVII. SECTION 504 AND AMERICANS WITH DISABILITIES ACT

The Agency has completed a 504/ADA Self-Evaluation Questionnaire for all programs and services offered by the Agency (including any services not subject to this Contract), and has evaluated its services, programs and employment practices for compliance with Section 504 of the Rehabilitation Act of 1973, 29 U.S.C. 701 et seq. as amended ("504") and the ADA, 42 U.S.C. 12101 et seq. The Agency has completed, attached as an Exhibit to this Contract, and incorporated herein by reference a 504/ADA Assurance of Compliance.

XVIII. SUBCONTRACTS AND PURCHASES

- A. The Agency shall include the above Sections IV, V, VI, VII, VIII, XIII, XIV, XV, XVI, and XVII, in every subcontract or purchase agreement for services which relate to the subject matter of this Contract.
- B. The Agency agrees to include the following language verbatim in every subcontract, provider agreement, or purchase agreement for services which are the subject matter of this Contract:

"[Subcontractor] shall protect, defend, indemnify, and hold harmless King County, its officers, employees and agents from any and all costs, claims, judgments, and/or awards of damages arising out of, or in any way resulting from the negligent act or omissions of subcontractor, its officers, employees, and/or agents in connection with or in support of this Contract. Subcontractor expressly agrees and understands that King

County is a third party beneficiary to this Contract and shall have the right to bring an action against subcontractor to enforce the provisions of this paragraph."

XIX. CONFLICT OF INTEREST

- A. The Agency agrees that it will not willfully attempt to secure preferential treatment in its dealings with the County by offering any valuable consideration, thing of value or gift, whether in the form of services, loan, thing or promise, in any form to any County official or employee. The Agency acknowledges that if it is found to have violated the prohibition found in this paragraph, its current contracts with the County shall be cancelled and it shall not be able to bid on any County contract for a period of two years.
- B. The Agency acknowledges that for one year after leaving County employment, a former County employee may not have a financial or beneficial interest in a contract or grant that was planned, authorized, or funded by a County action in which the former County employee participated during County employment. Agency shall identify, at the time of offer, current or former County employees involved in the preparation of proposals or the anticipated performance of work if awarded the Contract. Failure to identify current or former County employees involved in this transaction may result in the County's denying or terminating this Contract. Before making an employment offer to a person who has less than a year separation from County employment, the Agency shall confirm with the person being tended the employment offer of their compliance with KCC Chapter 3.04 and this paragraph.
- C. Failure to comply with this Section XIX shall be a material breach of this Contract, and may result in termination of this Contract pursuant to Section XI and subject the Agency to the remedies stated therein, or otherwise available to the County at law or in equity.

XX. BOARD OF DIRECTORS

The Agency shall qualify at all times as a non-profit corporation under U.S.C., Subtitle A., Chapter 1; Subchapter F, Part 1, and Section 501(c)(3).

The Agency shall have an active, legally constituted board of directors in accordance with RCW Chapters 23B or 24 that shall be comprised of neither employees nor relatives of employees, officers or directors of the Agency, except as approved by the County under this Section. The Director may be an ex officio member of the Board of Directors. For the purposes of this Section, a relative is defined as a husband, wife, father, father-in-law, mother, mother-in-law, brother, brother-in-law, sister, sister-in-law, son-in-law, daughter-in-law, niece, nephew, grandparent, grandchild, uncle, aunt, child, child of domestic partner, and domestic partner. In addition, the relatives of a domestic partner shall be considered relatives to the same extent such relatives would be included in this Section, as if the employee and domestic partner were married. The Board of Directors shall meet regularly and fulfill all of the duties under applicable Washington State law and federal law.

The Board of Directors shall maintain a formal conflict of interest policy for Board members that complies with the applicable provisions of the Internal Revenue Code 501(c)(3) status, and addresses issues regarding gifts, financial gain, and improper use of position.

The Contract shall be reviewed and approved for Agency signature by the Agency's Board of Directors.

Each amendment to this Contract must be approved by the Agency's Board of Directors.

A. **Interests of Agency Management and Agency Board:**

The following shall be disallowed and shall be considered a conflict of interest without prior disclosure and approval of the County:

1. The Agency shall not employ an individual who is related to a director or assistant director of the Agency or an Agency Board member, either as an employee, contractor or through a corporation. This provision shall not apply when the total compensation paid to the individual is less than \$500 per annum.
2. The Agency shall not acquire or rent real and/or personal property owned or rented by either:
 - a. an employee or Board member of the Agency;
 - b. a relative of an employee or Board member of the Agency; or
 - c. a corporation in which an employee or Board member of the Agency, or a relative of such a person, has ownership.

B. Failure to comply with any provision of this Section XX shall constitute a material breach of this Contract.

XXI. MANAGING DIRECTOR OF AGENCY

The managing director of the Agency shall be an attorney licensed to practice law in the State of Washington. The managing director shall be a salaried employee of the Agency, subject to the authority and control of the Board of Directors of the Agency. The managing director of the Agency shall be responsible for receiving funds into program accounts or issuing financial documents, checks, or other instruments of payment for program costs provided pursuant to this Contract.

XXII. POLITICAL ACTIVITY PROHIBITED

No funds, materials, property, or services provided directly or indirectly under this Contract shall be used for any partisan political activity or to further the election or defeat of any candidate for public office.

XXIII. EQUIPMENT PURCHASE, MAINTENANCE, AND OWNERSHIP

- A. The Agency agrees that any equipment purchased with Contract funds at a cost of \$5,000 per item or more, and identified in an exhibit as reimbursable, is upon its purchase or receipt the property of the County, and/or federal, and/or state government as specified in the exhibit.
- B. The Agency shall be responsible for all such equipment, including the proper care and maintenance.
- C. The Agency shall ensure that all such equipment will be returned to the appropriate government agency, whether federal, state or County, upon written request of the County.

- D. The Agency shall admit County staff to the Agency's premises for the purpose of marking such equipment with appropriate government property tags.
- E. The Agency shall establish and maintain inventory records and transaction documents (purchase requisitions, packing slips, invoices, receipts) of equipment purchased with Contract identified funds.

XXIV. NOTICES

Whenever this Contract provides for notice to be provided by one party to another, such notice shall be:

- A. In writing; and

Directed to the managing director of the Agency, the President of the Board of Directors of the Agency, The Office of the Public Defender, and the director of the Department of Community and Human Services.

- B. Any due date within which a party must take some action shall be computed according to CR 6(a). If notice is provided by US Post, CR 5(b)(2)(A) shall apply to determine the date of service.

XXV. PROPRIETARY RIGHTS

The parties to this Contract hereby mutually agree that if any patentable or copyrightable material or article is the product of work performed for the County as described herein, all rights accruing from such material or article shall be the sole property of the Agency. The Agency agrees to and does hereby grant to the County, irrevocable, nonexclusive, and royalty-free license to use, according to law, any material or article and use any method that may be developed as part of the work under this Contract.

The foregoing products license shall not apply to existing training materials, consulting aids, checklists, and other materials and documents of the Agency which are used in the performance of this Contract.

XXVI. CONTRACT AMENDMENTS

Either party may request changes to this Contract. Proposed changes which are mutually agreed upon shall be incorporated by written amendments to this Contract.

XXVII. KING COUNTY RECYCLED PRODUCT PROCUREMENT POLICY

The Agency shall use recycled paper for the production of all printed and photocopied documents related to the fulfillment of this Contract and shall ensure that, whenever possible, the cover page of each document printed on recycled paper bears an imprint identifying it as recycled paper. All Court document production shall be covered by Court rules.

If the cost of recycled paper is more than 15 percent higher than the cost of non-recycled paper, the Agency may notify the Contract Administrator, who may waive the recycled paper requirement.

The Agency shall use both sides of paper sheets for copying and printing and shall use recycled/recyclable products wherever practical in the fulfillment of this Contract.

XXVIII. SERVICES PROVIDED IN ACCORDANCE WITH LAW AND RULE AND REGULATION

The Agency and any subcontractor agree to abide by all of the laws of the State of Washington that are applicable to their business and the substance of the legal services that are the subject of this Contract. The Agency and any subcontractors also agree to abide by all Rules of Professional Conduct governing attorney conduct and to abide by the requirements of the attorney-client privilege, as defined by Washington statutory law and common law.

In the event that there is a conflict between any of the language contained in any exhibit or attachment to this Contract, the language in the Contract shall have control over the language contained in the exhibit or the attachment, unless the parties affirmatively agree in writing to the contrary.

XXIX. CONFIDENTIALITY

The Agency agrees that information, records, and data collected in connection with this Contract shall be protected from unauthorized disclosure in accordance with applicable common law, state and federal law, including but not limited to attorney-client privilege. The County agrees that the King County Office of The Public Defender shall protect any information received from the Agency from unauthorized disclosure in accordance with applicable common law, state and federal law, including but not limited to attorney-client privilege.

The County, through the Office of The Public Defender, shall abide by any applicable law of privilege in monitoring the Agency's performance under this Contract.

XXX. COMPLIANCE WITH THE HEALTH INSURANCE PORTABILITY ACCOUNTABILITY ACT OF 1996

Terms used in this Section shall have the same meaning as those terms in the Privacy Rule, 45 CFR Parts 160 and 164.

A. Obligations and Activities of the Agency

1. The Agency agrees not to acquire, use, or disclose protected health information other than as permitted or required by law.
2. The Agency agrees to implement administrative, physical, and technical safeguards that reasonably and appropriately protect the confidentiality, integrity, and availability of the protected health information that it creates, receives, maintains, or transmits on behalf of the County as required by CFR Title 45, Section 164, Subpart C.
3. The Agency agrees to mitigate, to the extent practicable, any harmful effect that is known to the Agency of a use or disclosure of protected health information by the Agency in violation of the requirements of this Contract.
4. The Agency agrees to report in writing all unauthorized or otherwise improper disclosures of a client's protected health information or security incident to the County by the Agency within two days of the Agency knowledge of such event.
5. The Agency agrees to ensure that any agent, including a subcontractor, to whom it provides protected health information received from, or created or received by the Agency on behalf of the County, agrees to the same restrictions

and conditions that apply through this Contract to the Agency with respect to such information.

6. The Agency agrees to make available protected health information in accordance with 45 CFR § 164.524.
7. The Agency agrees to make available protected health information for amendment and incorporate any amendments to protected health information in accordance with 45 CFR § 164.526.
8. The Agency agrees to make internal practices, books, and records, including policies and procedures and protected health information, relating to the use and disclosure of protected health information received from, or created or received by the Agency on behalf of King County, available to the Secretary, in a reasonable time and manner for purposes of the Secretary determining King County's compliance with the Privacy Rule.
9. The Agency agrees to make available the information required to provide an accounting of disclosures in accordance with 45 CFR § 164.528.

B. Permitted Uses and Disclosures by Business Associate

The Agency may use or disclose protected health information to perform functions, activities, or services for, or on behalf of, King County as specified in this Contract, provided that such use or disclosure would not violate the Privacy Rule if done by King County or the minimum necessary policies and procedures of King County.

C. Effect of Termination

1. Except as provided in Paragraph C.2. of this Section, upon termination of this Contract, for any reason, the Agency shall return or destroy all protected health information received from King County, or created or received by the Agency on behalf of King County. This provision shall apply to protected health information that is in the possession of subcontractors or agents of the Agency. The Agency shall retain no copies of the protected health information.
2. In the event the Agency determines that returning or destroying the protected health information is infeasible, the Agency shall provide to King County notification of the conditions that make return or destruction infeasible. Upon notification that return or destruction of protected health information is infeasible, the Agency shall extend the protections of the Contract to such protected health information and limit further uses and disclosure of such protected health information to those purposes that make the return or destruction infeasible, for so long as the Agency maintains such protected health information.

XXXI. NO THIRD PARTY BENEFICIARIES

Except for the Parties to whom this Contract is assigned in compliance with the terms of this Contract, there are no third party beneficiaries to this Contract, and this Contract shall not impart any rights enforceable by any person or entity that is not a Party hereto.

XXXII. ENTIRE CONTRACT/WAIVER OF DEFAULT

The parties agree that this Contract is the complete understanding of the terms hereto and any oral or written representations or understandings not incorporated herein are excluded. Both parties recognize that time is of the essence in the performance of the provisions of this Contract. Waiver of any default shall not be deemed to be a waiver of any other or subsequent breach and shall not be construed to be a modification of the terms of the Contract unless stated to be such through written approval by the County, a copy of which shall be attached to the original copy of this Contract.

XXXIII. GOVERNING LAW/SEVERABILITY/CONSTRUCTION

This Contract shall be governed by Washington law. If any one or more provisions of this Contract shall be held by any court to be invalid or unenforceable, such invalidity or unenforceability shall not adversely affect the validity or enforceability of any other part of this Contract. This Contract shall not be construed for nor against any party, regardless of its drafter.

KING COUNTY

 FOR
King County Executive

12/27/07
Date

Signature

BRUCE D. ERICKSON
NAME (Please type or print)

12/19/07
Date

Approved as to Form:

OFFICE OF THE KING COUNTY
SPECIAL DEPUTY PROSECUTOR

Date: 11/29/07

EXHIBIT I

Certificate of Insurance/Endorsements

ACORD CERTIFICATE OF LIABILITY INSURANCE

PRODUCER Degginger McIntosh & Assoc. PO Box 1400 3977 Harbour Pointe SW Mukilteo WA 98275 Phone: 425-740-5200 Fax: 425-740-5201	OP ID RW DEF5000	DATE (MM/DD/YYYY) 12/11/07
THIS CERTIFICATE IS ISSUED AS A MATTER OF INFORMATION ONLY AND CONFERS NO RIGHTS UPON THE CERTIFICATE HOLDER. THIS CERTIFICATE DOES NOT AMEND, EXTEND OR ALTER THE COVERAGE AFFORDED BY THE POLICIES BELOW.		
INSURED The Defender Association 810 3rd Avenue, Ste. 800 Seattle WA 98104-1695	INSURERS AFFORDING COVERAGE	NAIC #
	INSURER A: Travelers Cas Ins Co of America	
	INSURER B: The Travelers Indemnity Co.	25658
	INSURER C: Columbia Casualty Company	
	INSURER D:	
	INSURER E:	

COVERAGES

THE POLICIES OF INSURANCE LISTED BELOW HAVE BEEN ISSUED TO THE INSURED NAMED ABOVE FOR THE POLICY PERIOD INDICATED. NOTWITHSTANDING ANY REQUIREMENT, TERM OR CONDITION OF ANY CONTRACT OR OTHER DOCUMENT WITH RESPECT TO WHICH THIS CERTIFICATE MAY BE ISSUED OR MAY PERTAIN, THE INSURANCE AFFORDED BY THE POLICIES DESCRIBED HEREIN IS SUBJECT TO ALL THE TERMS, EXCLUSIONS AND CONDITIONS OF SUCH POLICIES. AGGREGATE LIMITS SHOWN MAY HAVE BEEN REDUCED BY PAID CLAIMS.

INSR	MULTI	TYPE OF INSURANCE	POLICY NUMBER	POLICY EFFECTIVE DATE (MM/DD/YY)	POLICY EXPIRATION DATE (MM/DD/YY)	LIMITS
A	X	GENERAL LIABILITY <input checked="" type="checkbox"/> COMMERCIAL GENERAL LIABILITY <input type="checkbox"/> CLAIMS MADE <input checked="" type="checkbox"/> OCCUR	I6805964L49AACJ07	11/19/07	11/19/08	EACH OCCURRENCE \$ 1,000,000 DAMAGE TO RENTED PREMISES (Ea occurrence) \$ 300,000 MED EXP (Any one person) \$ 5,000 PERSONAL & ADV INJURY \$ 1,000,000 GENERAL AGGREGATE \$ 2,000,000 PRODUCTS - COMP/OP AGG \$ 2,000,000
A		AUTOMOBILE LIABILITY <input type="checkbox"/> ANY AUTO <input type="checkbox"/> ALL OWNED AUTOS <input type="checkbox"/> SCHEDULED AUTOS <input checked="" type="checkbox"/> HIRED AUTOS <input checked="" type="checkbox"/> NON-OWNED AUTOS	I6805964L49AACJ07 I6805964L49AACJ07	11/19/07 11/19/07	11/19/08 11/19/08	COMBINED SINGLE LIMIT (Ea accident) \$ Included BODILY INJURY (Per person) \$ BODILY INJURY (Per accident) \$ PROPERTY DAMAGE (Per accident) \$ AUTO ONLY - EA ACCIDENT \$ OTHER THAN AUTO ONLY: EA ACC AGG \$
		GARAGE LIABILITY <input type="checkbox"/> ANY AUTO				AUTO ONLY - EA ACCIDENT \$ OTHER THAN AUTO ONLY: EA ACC AGG \$
B		EXCESS/UMBRELLA LIABILITY <input checked="" type="checkbox"/> OCCUR <input type="checkbox"/> CLAIMS MADE <input type="checkbox"/> DEDUCTIBLE <input checked="" type="checkbox"/> RETENTION \$ 5,000	ISFCUP7596Y052IND07	11/19/07	11/19/08	EACH OCCURRENCE \$ 3,000,000 AGGREGATE \$ 3,000,000
		WORKERS COMPENSATION AND EMPLOYERS LIABILITY ANY PROPRIETOR/PARTNER/EXECUTIVE OFFICER/MEMBER EXCLUDED? If yes, describe under SPECIAL PROVISIONS below				WC STATUTORY LIMITS \$ OTHER \$ E.L. EACH ACCIDENT \$ E.L. DISEASE - EA EMPLOYEE \$ E.L. DISEASE - POLICY LIMIT \$
C		Professional Liab Deduct \$2,500	NLA000800450	03/01/07	03/01/08	Per Occur \$ 2,000,000 Aggregate \$ 2,000,000

DESCRIPTION OF OPERATIONS / LOCATIONS / VEHICLES / EXCLUSIONS ADDED BY ENDORSEMENT / SPECIAL PROVISIONS
 King County, it officers, officials, employees & agents are included as Additional Insured per form CGD037(0405) with respects to any & all operations of Named Insured.

CERTIFICATE HOLDER

CANCELLATION

KING008 King County, Office of the Public Defender Walthew Bldg. 123 3rd Avenue, S, Floor 4 Seattle WA 98104-2696	SHOULD ANY OF THE ABOVE DESCRIBED POLICIES BE CANCELLED BEFORE THE EXPIRATION DATE THEREOF, THE ISSUING INSURER WILL ENDEAVOR TO MAIL 45 DAYS WRITTEN NOTICE TO THE CERTIFICATE HOLDER NAMED TO THE LEFT, BUT FAILURE TO DO SO SHALL IMPOSE NO OBLIGATION OR LIABILITY OF ANY KIND UPON THE INSURER, ITS AGENTS OR REPRESENTATIVES. AUTHORIZED REPRESENTATIVE Kenneth McIntosh
---	--

ACORD 25 (2001/08)



King County

EXHIBIT II

Personnel Inventory Report

Legal name of business The Defender Association Contract No: _____
 dba (if applicable) _____ Telephone No: 206-447-3900
 Street address 910 3rd Ave #300 City Seattle State WA Zip Code 98104
 Submitted by: Cynthia Donion Title Admin Asst Date 12/19/07

Do you have any employees? No ___ Yes X Sole Owner/Operator No X Yes ___

If yes, list on the Employment Data Chart below the total number of employees for all businesses located within each location listed below. Indicate which locale (1,2,3) report covers. This report is for Payroll Period ending (Month/Day/Year): 12/05/07 and covers the following locale: (Check only one box)

1. X Business located within King County 3. ___ Business located with U. S.
 2. ___ Businesses located within WA State 4. ___ Other (specify) _____

Do any of your employees belong to a union and/or do you use an employee referral agency? No ___ Yes X

If yes, list the unions and/or employee referral agencies with whom you have agreements: SEIU Local #925. If you expect to do more than \$10,000 worth of public work (construction) or, more than \$25,000 worth of business with King County, the unions or employee referral agencies must submit a statement of compliance with King County Code Chapter 12.16.

Job Categories	Whites		African Americans		Asians		Native Americans		Hispanics		Disabled		Minority Subtotal		Disabled Subtotal	
	M	F	M	F	M	F	M	F	M	F	M	F	M	F	M	F
Managerial		5			1								1			
Professional	28	30	3	4	3	2		1		3		1	6	10		1
Invest.	4	9			1					1			1	1		
Clerical	1	2	2	4		2			1	1		1	5	7		1
Soc. Wrkrs.	2	3		1										1		
Paralgl's	2	4	1	2					1				2	2		
Labor																
On-Job Trainees																
Apprentice																
Skilled Craft Total*																
Total	37	53	6	11	5	4		1	2	5		2	15	21		2

* Journey worker: List by classification on reverse, e.g., carpenter, plumber, etc.

Total number of employees reported above: 126 If no employees, write "0."



King County

EXHIBIT III

Affidavit and Certificate of Compliance

with King County Code Chapter 12.16, Discrimination and Affirmative Action in Employment by Contractors, Subcontractors and Vendors

The undersigned, being first duly sworn, on oath states, s/he is authorized by the Contractor, and on the Contractor's behalf, affirms and certifies as follows:

Definitions: "Contractor" shall mean any contractor, vendor or consultant who supplies goods and/or services. "Contract" shall mean any contract, purchase order or agreement with King County Government, hereinafter called the County.

- A. Contractor recognizes that discrimination in employment is prohibited by federal, state and local laws. Contractor recognizes that in addition to refraining from discrimination, affirmative action is required to provide equal employment opportunity. Contractor further recognizes that this Affidavit establishes minimum requirements for affirmative action and fair employment practices and implements the basic nondiscrimination provisions of the general contract specifications as applied to service, consultant, and vendor contracts exceeding \$25,000, or public work contracts exceeding \$10,000. Contractor herein agrees that this Affidavit is incorporated as an addendum to its general contract, and recognizes that failure to comply with these requirements may constitute grounds for application of sanctions as set forth in the general specifications, King County Code Chapter 12.16 ("Chapter") and this Affidavit. PROVIDED FURTHER, that in lieu of this Affidavit, the Executive may accept a statement pledging adherence to an existing contractor affirmative action plan where the provisions of the plan are found by the Executive to substantially fulfill the requirements of the Chapter.
- B. Contractor shall give notice to their supervisors and employees of the requirements for affirmative action to be undertaken prior to the commencement of work.
- C. This person has been designated to represent the Contractor and to be responsible for securing compliance with and for reporting on the affirmative actions taken:
- D. Contractor will cooperate fully with the BD and Contract Compliance Section and appropriate County agents while making every reasonable "good faith" effort to comply with the affirmative action and nondiscrimination requirements set forth in this Affidavit and in King County Code Chapter 12.16.
- E. **Reports:** The Contractor agrees to complete and submit as required such additional reports and records that may be necessary to determine compliance with the Affidavit and to confer with the County Compliance Officer at such times as the County shall deem necessary. The information required by the Chapter includes but is not limited to the following reports and records:
 1. **Personnel Inventory Report:** This report shall include a breakdown of the Contractor's workforce showing race, sex and handicapped and other minority data.
 2. **Monthly EEO Report:** This report shall apply to construction contractors and subcontractors and shall provide the number of employees for all employees, including minority, women and disabled employees by craft and category.
 3. **Statement from Union or Worker Referral Agency:** This statement affirms that the signee's organization has no practices and policies which discriminate on the basis of race,

color, creed, religion, sex, age, marital status, sexual orientation, nationality or the presence of sensory, mental or physical disability.

The information required in this section shall be submitted on forms provided by the County unless otherwise specified.

- F. **Subcontractors:** For public works projects and contracts over ten thousand dollars (\$10,000) the prime contractor shall be required to submit to the County, along with its qualifying documents under the Chapter, employment profiles, Affidavits and Certificates of Compliance, Reports and Union Statements from its subcontractors in the same manner as these are required of the prime contractor. Reporting requirements of the prime contractor during the contract period will apply equally to all subcontractors.
- G. **Employment Goals for Minorities, Women and Persons with Disabilities:** No specific levels of utilization of minorities and women in the workforce of the Contractor shall be required, and the Contractor is not required to grant any preferential treatment on the basis of race, sex, color, ethnicity or national origin in its employment practices. Notwithstanding the foregoing, any affirmative action requirements set forth in any federal regulations, statutes or rules included or referenced in the contract documents shall continue to apply.
- H. **Affirmative Action Measures:** Contractor agrees to implement and/or maintain reasonable good faith efforts to comply with King County Code Chapter 12.16. The evaluation of a contractor's compliance with the Chapter shall be based upon the contractor's effort to achieve maximum results from its affirmative action measures. The Contractor shall document these efforts and shall implement affirmative action steps at least as extensive as the following:
 1. **Policy Dissemination:** Internal and external dissemination of the contractor's equal employment opportunity policy; posting of nondiscrimination policies and of the requirement of the Chapter on bulletin boards clearly visible to all employees; notification to each subcontractor, labor union or representative of workers with which there is a collective bargaining agreement or other contract, subcontract, or understanding of the contractor's commitments under the Chapter. Inclusion of the equal opportunity policy in advertising in the news media and elsewhere.
 2. **Recruiting:** Adopt and implement recruitment procedures designed to increase the representation of women, minorities and persons with disabilities in the pool of applicants for employment: including, but not limited to establishing and maintaining a current list of minority, women and disabled recruitment sources, providing these sources written notification of employment opportunities and advertising vacant positions in newspapers and periodicals which have minority, women and/or disabled readership.
 3. **Self-Assessment and Test Validation:** Review of all employment policies and procedures, including tests, recruitment, hiring and training practices and policies, performance evaluations, seniority policies and practices, job classifications and job assignments to assure that they do not discriminate against, or have a discriminatory impact on, minorities, women and persons with disabilities and validate all tests and

EXHIBIT III

other selection requirements where there is an obligation to do so under state or federal law.

- 4. **Record Referrals:** Maintain a current file of applications of each minority, women and persons with disabilities who are applicants or referrals for employment indicating what action was taken with respect to each such individual and the reasons therefor. Contact these people when an opening exists for which they may be qualified. Names may be removed from the file after twelve months have elapsed from their last application or referral.
- 5. **Notice to Unions:** Provide notice to labor unions of the contractor's nondiscrimination and affirmative action obligations pursuant to King County Code Chapter 12.16. Contractors shall also notify the BD and Contract Compliance Section if labor unions fail to comply with the nondiscrimination or affirmative provisions
- 6. **Supervisors:** Ensure that all supervisory personnel understand and are directed to adhere to and implement the nondiscrimination and affirmative action obligations of the contractor under King County Code Chapter 12.16. Such direction shall include, but not be limited to, adherence to, and achievement of, affirmative action policies in performance appraisals of supervisory personnel.
- 7. **Employee Training:** When reasonable, develop on-the-job training opportunities which expressly include minorities, women, and persons with disabilities and sponsor and/or utilize, training/educational opportunities for the advancement of women, minorities and persons with disabilities employed by the contractor, subject to acceptance by the county.
- 8. **Responsible Person:** Designate an employee who shall have the responsibility for implementation of the Contractor's affirmative action measures.
- 9. **Progress Reporting:** Prepare as part of the affirmative action plan an analysis and report on the progress made toward eliminating the underrepresentation of minorities, women, and persons with disabilities in the contractor's workforce on

an annual basis.

- I. During the performance of this Contract, neither the Contractor nor any party subcontracting under the authority of this Contract shall discriminate nor tolerate harassment on the basis of race, color, sex, religion, nationality, creed, marital status, sexual orientation, age, or the presence of any sensory, mental or physical disability in the employment or application for employment or in the administration or delivery of services or any other benefits under this Contract.
- J. Contractor agrees to provide reasonable access upon request to the premises of all places of business and employment, relative to work undertaken in this Contract, and to records, files, information and employees in connection therewith, to the BD and Contract Compliance Section or agent for purposes of reviewing compliance with the provisions of this Affidavit and agrees to cooperate in any compliance review.
- K. Should the BD and Contract Compliance Section find, upon complaint investigation or review, the Contractor not to be in good faith compliance with the provisions contained in this Affidavit, it shall notify the County and Contractor in writing of the finding fully describing the basis of non-compliance. Contractor may request withdrawal of such notice of noncompliance at such time as the compliance office has notified in writing the Contractor and the County that the noncompliance has been resolved.
- L. The Contractor agrees that any violation of any term of this Affidavit, including reporting requirements, shall be deemed a violation of King County Code Chapter 12.16. Any such violation shall be further deemed a breach of a material provision of the Contract between the County and the Contractor. Such breach may be grounds for implementation of any sanctions provided for in the Chapter, including but not limited to, cancellation, termination or suspension, in whole or part, of the Contractor by the County; liquidated damages; or disqualification of the Contractor PROVIDED, that the implementation of any sanctions is subject to the notice and hearing provisions of King County Code Chapter 12.16.110.

Contractor: The Defender Association 810 3rd Ave. #800 Seattle, WA 98104
Company Name Street Address City State Zip

I have read and understood the foregoing; and am authorized on behalf of the Contractor to agree to the terms and conditions of this and Affidavit and Certificate of Compliance and therefore, execute the same.

Authorized Signer: Floris J. Mikkelson Director 206-447-3900 Floris J. Mikkelson
Name (type or print) Title Phone Signature

VALID ONLY IF NOTARIZED

SUBSCRIBED AND SWORN TO BEFORE ME THIS 19 DAY OF December, 2007.

Verena Hochstetler
 Notary Public in and of the state of Washington

Residing at: Seattle



EXHIBIT IV

504/ADA SELF-EVALUATION AND ASSURANCE OF COMPLIANCE

Instructions

504/ADA Self-Evaluation Questionnaire Form

This form will help you evaluate your organization's or firm's programs and services, employment, and facilities to ensure they are accessible to people with disabilities. Complete the 504/ADA Self-Evaluation Questionnaire and keep it on file at your office. Do not return the questionnaire with your contract.

"Quick Look" Barriers Checklist

Note: If the business is a construction company, this form pertains only to the main office, not the construction sites. Firms that provide services outside their office do not need to write a corrective action plan for physical accessibility as long as these services are provided in an accessible location for people with disabilities who cannot access the office. However, physical access must also be reviewed in light of hiring an individual with a disability or accommodating a current employee who becomes disabled.

504/ADA Assurance of Compliance Form

All contractors must complete this form, as required by King County Code 12.16.060. Governmental agencies and contracts for the direct purchase of goods are exempt.

- **Complete this form.** If your organization or firm is out of compliance with any of the 504/ADA requirements, indicate on the 504/ADA Disability Assurance of Compliance form the corrective actions that will be taken to achieve compliance and the date these actions will be completed.
- **Sign the Assurance of Compliance form and send the original back with your contract.** Keep a copy of the form on file in your office for use during on-site reviews. You will be notified at least one week in advance of any scheduled review. (Note: This form may be used as an exhibit with other King County contracts for two years from the date the form is completed.)

If you have questions regarding this process, or if you require this material in an alternate format, please contact a King County 504/ADA Disability Compliance Specialist at 206-296-7592 or 206-296-7596 TTY, or by e-mail: Civil-Rights.OCR@kingcounty.gov.

504/ADA General Information

Federal and State laws prohibit discrimination based on disability. Section 504 of the Rehabilitation Act of 1973, as amended (504), and the Americans with Disabilities Act of 1990 (ADA) require that King County and all organizations and firms contracting with King County, except those providing tangible goods, comply with the 504/ADA accessibility requirements.

Under 504 and ADA, a "qualified individual with a disability" is anyone who has, has a history of, or is perceived as having a physical or mental impairment which substantially limits one or more major life activities. Disabilities include, but are not limited to: mobility, visual, hearing, or speech disabilities; mental illness; epilepsy; learning disability; brain injury; HIV/AIDS; arthritis; cerebral palsy; multiple sclerosis; developmental disability; and alcohol and/or drug addiction.

DISABILITY RESOURCE LIST

Note: Inclusion in this resource list does not constitute endorsement by King County Government, nor does omission imply non-endorsement. Our goal is to provide you with information on some key resources available. Please contact us if you know of a useful resource missing from this list.

King County Office of Civil Rights

Disability Compliance Specialist, Yesler Building, 400 Yesler Way, Room 260, Seattle, WA 98104-2683; 206-296-7592 V, 206-296-7596 TTY; 206-296-4329 Fax; e-mail: Civil-Rights.OCR@kingcounty.gov
web site: www.metrokc.gov/dias/ocre

Governor's Committee on Disability Issues and Employment (GCDE)

Advises and informs the Governor, state and local governments, the business community, and the disability community on ADA and other issues related to disability policy.

Olympia: 360-438-3168 V, 360-438-3167 TTY; Spokane: 509-532-3149 V, 509-532-3113 TTY.

GCDE publishes "Producing Materials in Alternative Formats: A Guide for Agencies"

which provides information on producing materials in large print, on audio tape or computer disk, and Braille. Send a written request for a copy.

DBTAC Northwest

Provides information on the Americans with Disabilities Act in Alaska, Idaho, Oregon and Washington. Western Washington University 6912 220th St. SW, Suite 105

Mountlake Terrace, WA 98043

800-949-4232 V/TTY

425-774-9303 Fax

e-mail: dbtacnw@wwwu.edu

web site: www.dbtacnorthwest.org

Sprint Washington Telecommunications Relay Service (TRS)

Provides free telephone accessibility with TTY users. 500 108th Avenue NE, Suite 800, Bellevue, WA 98004; Relay Services: 711 TTY; 800-833-6384 V.

ADA Technical Assistance Hotline (U.S. Dept. of Justice)

Provides free technical assistance and informational materials to people with disabilities, businesses, state and local government agencies, and the general public on rights and responsibilities under Titles II and III of the ADA. 800-514-0301 V/TTY.

web site: www.usdoj.gov/crt/ada

Washington Assistive Technology Alliance (WATA)

Information & referral to disability resources, including assistive technology options, funding sources, legal issues, accommodations.

509-328-9350 V/TTY; 800-214-8731 V/TTY;

509-326-2261 Fax; e-mail: spokane@seals.org

web site: wata.org/wata/eatrc/index.htm

Job Accommodations Network (JAN)

An international toll-free consulting service that provides information regarding the ADA, job accommodations and the employability of people with disabilities. P.O. Box 6080, 918 Chestnut Ridge Road, Suite 1, Morgantown, WV 26506-6080;

JAN ADA Information 800-526-7234 V/TTY;

800-ADA-WORK (232-9675) V/TTY;

web site: janweb.icdi.wvu.edu

Emergency Procedures for Employees with Disabilities in Office Occupancies

A procedural guideline funded by the U.S. Fire Administration and developed by the National Institute of Standards and Technology with assistance from the National Task Force on Life Safety and People with Disabilities. Write for a copy of Item Number FA -154: United States Fire Administration, 16825 South Seton Avenue, Emmitsburg, MD 21727.

504/ADA SELF-EVALUATION QUESTIONNAIRE

General Requirements

Please check the appropriate answers. If necessary, attach additional pages of explanation. If you have fewer than 15 employees, please skip the first section and start with "Program Access."

- | | YES | NO | N/A |
|---|--------------------------|--------------------------|--------------------------|
| 1. Do you have a 504/ADA coordinator? If so, who? | <input type="checkbox"/> | <input type="checkbox"/> | <input type="checkbox"/> |
| Name _____ | | | |
| Title _____ Phone _____ | | | |
| 2. Do you have an internal grievance procedure that allows for quick and prompt solutions for any complaints based on alleged noncompliance with 504/ADA? | <input type="checkbox"/> | <input type="checkbox"/> | <input type="checkbox"/> |
| 3. Do you have a policy that provides for notifying participants, applicants, employees, unions, and professional organizations holding collective bargaining or professional agreements that you do not discriminate on the basis of disability? | <input type="checkbox"/> | <input type="checkbox"/> | <input type="checkbox"/> |
| 4. Have you notified these individuals of your nondiscrimination policy? | <input type="checkbox"/> | <input type="checkbox"/> | <input type="checkbox"/> |
| 5. Do you provide ongoing staff training to ensure that staff fully understand your policy of nondiscrimination on the basis of disability and can take all appropriate steps to facilitate the participation of individuals with disabilities in agency programs and activities? | <input type="checkbox"/> | <input type="checkbox"/> | <input type="checkbox"/> |

Program Access

- | | | | |
|---|--------------------------|--------------------------|--------------------------|
| 1. Do you notify the public and other interested parties that agency meetings, board of director meetings, hearings, conferences, public appearances by elected officials, and interviews will be held in accessible locations? | <input type="checkbox"/> | <input type="checkbox"/> | <input type="checkbox"/> |
| 2. Do you notify the public and other interested parties that auxiliary aids (sign language interpreters, readers) will be provided, upon request, to participants with disabilities? | <input type="checkbox"/> | <input type="checkbox"/> | <input type="checkbox"/> |
| 3. Do you have a Teletypewriter (TTY), or do you use the statewide Telecommunications Relay Service to facilitate communication with individuals who use TTYs for communication purposes? | <input type="checkbox"/> | <input type="checkbox"/> | <input type="checkbox"/> |
| 4. Do you provide ongoing training to familiarize appropriate staff with the operation of the TTY (or Relay Service) and other effective means of communicating over the telephone with people with disabilities? | <input type="checkbox"/> | <input type="checkbox"/> | <input type="checkbox"/> |

Program Access (continued)

- | | YES | NO | N/A |
|--|--------------------------|--------------------------|--------------------------|
| 5. Do you make available, upon request, written material in alternate formats for people who have disabilities? (Alternate formats include large print, Braille, and audiocassette tapes) | <input type="checkbox"/> | <input type="checkbox"/> | <input type="checkbox"/> |
| 6. Are printed posters, announcements, and printed materials (including graphics) clearly legible and placed in physically accessible locations where print can be read from a wheelchair? | <input type="checkbox"/> | <input type="checkbox"/> | <input type="checkbox"/> |
| 7. If you have a mailing list for the purposes of information dissemination, does it include various disability groups? | <input type="checkbox"/> | <input type="checkbox"/> | <input type="checkbox"/> |
| 8. Are your TTY number and procedures for accessing your services printed on all material distributed to the public? | <input type="checkbox"/> | <input type="checkbox"/> | <input type="checkbox"/> |
| 9. Do you have a policy and procedure for safe emergency evacuation of people with disabilities from your facility(s)? | <input type="checkbox"/> | <input type="checkbox"/> | <input type="checkbox"/> |

Employment and Reasonable Accommodation

- | | | | |
|--|--------------------------|--------------------------|--------------------------|
| 1. When gathering affirmative action data regarding disabilities, do you make it clear that: | | | |
| • the information requested is intended for use solely in connection with reporting requirements; | | | |
| • the information is voluntary; | | | |
| • the information will be kept confidential; and | | | |
| • refusal to provide or providing the information will not subject the applicant or employee to any adverse treatment? | <input type="checkbox"/> | <input type="checkbox"/> | <input type="checkbox"/> |
| 2. If you make pre-employment medical inquiries or conduct pre-employment medical examinations: | | | |
| • Is the inquiry related to the applicant's ability to perform the job? | <input type="checkbox"/> | <input type="checkbox"/> | <input type="checkbox"/> |
| • Do you condition offers of employment on the results of these examinations? | <input type="checkbox"/> | <input type="checkbox"/> | <input type="checkbox"/> |
| • Is the examination required for <u>all</u> employees in the same job classification? | <input type="checkbox"/> | <input type="checkbox"/> | <input type="checkbox"/> |
| • Are <u>all</u> applicants in the same job classification asked the same medical and/or interview questions? | <input type="checkbox"/> | <input type="checkbox"/> | <input type="checkbox"/> |
| 3. During the application, interviewing, hiring, and employment process, do you provide reasonable accommodations to applicants and employees with disabilities? | <input type="checkbox"/> | <input type="checkbox"/> | <input type="checkbox"/> |

Employment and Reasonable Accommodation (continued)

YES NO N/A

4. Do you have a written policy stating the following?

504/ADA requires that information concerning an applicant's medical condition or history must be kept separate from personnel records and may be shared in only three ways:

- (1) supervisors and managers may be informed of restrictions on the work or duties of individuals with disabilities and informed of necessary accommodation(s);
- (2) first aid and safety personnel may be informed if the condition might require emergency treatment; and
- (3) government officials investigating compliance with 504/ADA shall be provided with relevant information upon request.

Physical Accessibility

Complete the "Quick Look" Barriers Checklist and then answer the following questions:

1. Is the building(s) where your business is located barrier-free?

2. If you checked NO to any of the items on the Employment and Reasonable Accommodation checklist above, would these areas prevent an individual with a disability from accessing your program(s) or service(s)?

If access would be impacted, describe on the Corrective Action Plan what steps will be taken to eliminate the barrier(s). If there are extenuating circumstances which would make barrier removal a financial or administrative burden, please explain in the Corrective Action Plan.

This 504/ADA Self-Evaluation Questionnaire was completed by:

Print name

Date

Phone Number

"QUICK LOOK" BARRIERS CHECKLIST

This checklist may be used to conduct a quick appraisal of potential problem areas for accessibility. For detailed review standards, refer to IBC 2003, ANSI A117.1-2003, and the Washington State Administrative Code (WAC) 51-50. If you are not located in State of Washington, you may refer to federal ADA Accessibility Guidelines (ADAAG), state or local laws and regulations.

Building Access

	YES	NO	N/A
• Garage/lot has required number of accessible parking spaces?	<input type="checkbox"/>	<input type="checkbox"/>	<input type="checkbox"/>
• Are accessible parking spaces near main building entrance?	<input type="checkbox"/>	<input type="checkbox"/>	<input type="checkbox"/>
• Walkways are level (44" wide min.) or ramped (max. 1:12)?	<input type="checkbox"/>	<input type="checkbox"/>	<input type="checkbox"/>
• Does the entrance doorway have at least 32" wide clearance?	<input type="checkbox"/>	<input type="checkbox"/>	<input type="checkbox"/>
• Is the door threshold maximum ¼" high (½" if beveled)?	<input type="checkbox"/>	<input type="checkbox"/>	<input type="checkbox"/>
• Door hardware is lever handles, pulls, or push-pull activating bars?	<input type="checkbox"/>	<input type="checkbox"/>	<input type="checkbox"/>
• Are the doors easy to open (exterior doors max. 8.5 lbs. opening force, interior doors 5 lbs. max.)?	<input type="checkbox"/>	<input type="checkbox"/>	<input type="checkbox"/>
• If revolving doors used, alternate accessible entrance available?	<input type="checkbox"/>	<input type="checkbox"/>	<input type="checkbox"/>

Building Corridors

• Is path of travel free of obstruction and at least 36" wide?	<input type="checkbox"/>	<input type="checkbox"/>	<input type="checkbox"/>
• Is floor surface stable, firm and slip resistant?	<input type="checkbox"/>	<input type="checkbox"/>	<input type="checkbox"/>
• Do obstacles (phones, fountains, etc.) protrude no more than 4"?	<input type="checkbox"/>	<input type="checkbox"/>	<input type="checkbox"/>
• If provided, minimum one public phone or water fountain accessible?	<input type="checkbox"/>	<input type="checkbox"/>	<input type="checkbox"/>
• Are elevator controls no higher than 48"?	<input type="checkbox"/>	<input type="checkbox"/>	<input type="checkbox"/>
• Are elevator markings in Braille and raised letters/numbers?	<input type="checkbox"/>	<input type="checkbox"/>	<input type="checkbox"/>
• Does elevator provide audible and visible signals?	<input type="checkbox"/>	<input type="checkbox"/>	<input type="checkbox"/>
• Floor of elevator cab is min. 51" x 68" (door offset) or 51" x 80" (door centered)?	<input type="checkbox"/>	<input type="checkbox"/>	<input type="checkbox"/>

Restrooms

• Door hardware is lever handles, pulls, or push-pull activating bars?	<input type="checkbox"/>	<input type="checkbox"/>	<input type="checkbox"/>
• Do restroom entrance doors have at least 32" wide clearance?	<input type="checkbox"/>	<input type="checkbox"/>	<input type="checkbox"/>
• Is restroom large enough for wheelchair turnaround (5' diameter)?	<input type="checkbox"/>	<input type="checkbox"/>	<input type="checkbox"/>
• Does accessible stall door have at least 32" wide clearance?	<input type="checkbox"/>	<input type="checkbox"/>	<input type="checkbox"/>
• Are grab bars provided in accessible toilet stalls?	<input type="checkbox"/>	<input type="checkbox"/>	<input type="checkbox"/>
• Toilet seat top is 17-19" above floor?	<input type="checkbox"/>	<input type="checkbox"/>	<input type="checkbox"/>
• Sink has clear knee space under basin; exposed pipes are insulated?	<input type="checkbox"/>	<input type="checkbox"/>	<input type="checkbox"/>
• Faucets are lever-operated or push-type?	<input type="checkbox"/>	<input type="checkbox"/>	<input type="checkbox"/>
• Are soap and towel dispensers no more than 40" from the floor?	<input type="checkbox"/>	<input type="checkbox"/>	<input type="checkbox"/>

Reception and Personnel Office

• Lower counter space in reception, customer service areas?	<input type="checkbox"/>	<input type="checkbox"/>	<input type="checkbox"/>
• Do doors have at least 32" wide clearance?	<input type="checkbox"/>	<input type="checkbox"/>	<input type="checkbox"/>
• Is the door easy to open (max. 5 lbs. opening force)?	<input type="checkbox"/>	<input type="checkbox"/>	<input type="checkbox"/>
• Door threshold is maximum ¼" high (½" if beveled)?	<input type="checkbox"/>	<input type="checkbox"/>	<input type="checkbox"/>
• Is the path of travel between furniture at least 36"?	<input type="checkbox"/>	<input type="checkbox"/>	<input type="checkbox"/>

Required Number of Accessible Parking Spaces

Total Garage/Lot Parking Spaces	Minimum No. of Accessible Spaces
1-25	1 (van accessible)
26-50	2 (including one van space)
51-75	3 (including one van space)
76-100	4 (including one van space)
101-150	5 (including one van space)
151-200	6 (including one van space)
201-300	7 (including two van spaces)
301-400	8 (including two van spaces)
401-500	9 (including two van spaces)
501-1000	2% of total spaces (every six accessible spaces include one van space)
More than 1000	20, plus 1 for each 100 over 1000 (every six accessible spaces include one van space)

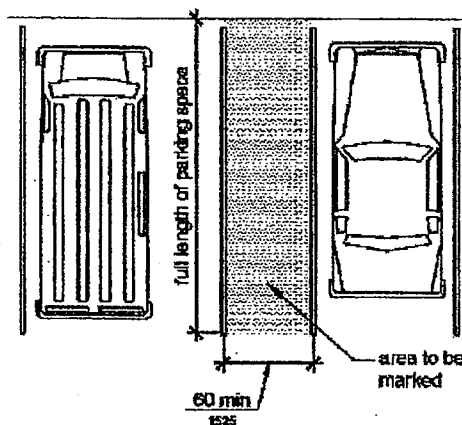

Locate accessible parking spaces on the shortest accessible route of travel to an accessible building entrance (where practical, not crossing traffic lanes).

Car and van parking spaces shall have an adjacent access aisle. Two parking spaces may share an access aisle. Van parking spaces that are angled shall have access aisles located on the passenger side of the parking space.

If there is only one accessible parking space, then it shall meet the codes for a van accessible parking space: 11' wide vehicle parking space plus a 5' access aisle. (An 8' vehicle parking space with an 8' access aisle is acceptable under code.)

For more detail, consult Washington State Building Code (WAC 51-50).

504/ADA DISABILITY ASSURANCE OF COMPLIANCE

Complying with Section 504 of the Rehabilitation Act of 1973, as amended, and the Americans With Disabilities Act of 1990, two federal laws which prohibit discrimination against qualified people with disabilities.

I understand that federal and state laws prohibit discrimination in public accommodations and employment based solely on disability. In addition, I recognize that Section 504 requires recipients of federal funds (either directly or through contracting with a governmental entity receiving federal funds) to make their programs, services, and activities, when viewed in their entirety, accessible to qualified and/or eligible people with disabilities. I agree to comply with, and to require that all subcontractors comply with, the Section 504/ADA requirements. I understand that reasonable accommodation is required in both program services and employment, except where to do so would cause an undue hardship or burden.

I agree to cooperate in any compliance review and to provide reasonable access to the premises of all places of business and employment and to records, files, information, and employees therein to King County for reviewing compliance with Section 504 and ADA requirements.

I agree that any violation of the specific provisions and terms of the 504/ADA Disability Assurance of Compliance and/or Corrective Action Plan required herein or Section 504 or the ADA, shall be deemed a breach of a material provision of the Contract between the County and the Contractor. Such a breach shall be grounds for cancellation, termination, or suspension, in whole or in part, of this Contract by the County.

According to the responses to the questions in the 504/ADA Self-Evaluation Questionnaire, Contractor is in compliance with 504/ADA. If the response is NO, the actions outlined in the below Corrective Action Plan will be taken. YES NO

Contractor: The Defender Association
Company Name
810 3rd. Ave. #800 Seattle, WA 98104
Street Address City State Zip

Corrective Action Plan

The following Corrective Action Plan is submitted to comply with Section 504 and ADA requirements.

Actions To Be Taken	General Requirements	Completion Date

504/ADA DISABILITY ASSURANCE OF COMPLIANCE (continued)

Actions To Be Taken	Program Access	Completion Date

Actions To Be Taken	Employment and Reasonable Accommodation	Completion Date

Actions To Be Taken	Physical Accessibility	Completion Date

I Declare Under Penalty of Perjury under the Laws of the State of Washington that the Foregoing is True and Correct.

Floris J. Mikkelsen
Signature of authorized signator

Floris J. Mikkelsen Director 206-447-3900
Type or print name of authorized signator Title Telephone

For Notary:

State of Washington , County of King

Signed and sworn before me on (date) Dec. 24, 2007 by (print authorized signator name) Floris J. Mikkelsen



Notary signature: Kathy Gilman

Notary (print name): Kathy Gilman

My appointment expires: 9/26/09

Note: This form is to be used as an exhibit with other King County contracts for two years from the date the form is completed.

EXHIBIT V

PUBLIC DEFENSE LEGAL SERVICES

I. WORK STATEMENT

The Agency shall provide the services of attorneys and staff members in compliance with all of the applicable laws and administrative regulations of the State of Washington, the United States, King County Code (KCC), Washington State Rules for Professional Conduct (RPC).

II. PROGRAM DESCRIPTION

A. Goal

To provide legal services through effective assistance of counsel to indigent persons, that is statutorily and constitutionally based, within the framework of an efficient and fiscally responsible independent non-profit Agency.

B. Eligible Population

The population served shall be indigent persons legally entitled to appointed legal services in King County courts as assigned by the Office of The Public Defender (OPD) or as appointed from the bench.

C. Definitions

1. Case Categories:

a. Becca: CHINS/ARY/Truancy practice area:

- i. CHINS/ARY Petition: A Child in Need of Services (CHINS) petition and At Risk Youth (ARY) petition involves the representation of one child or one parent from the filing of the petition through conclusion of services related to the petition. This includes representation on the initial petition, as well as any subsequent review hearings. In the event that a court consolidates a truancy matter with proceedings under a Youth at Risk or Child in Need of Services Petition, the Agency shall receive credit for the truancy representation.
- ii. Truancy: A petition filed under Revised Code of Washington (RCW) 28A.225.030. A case assignment will be made when the Court notifies OPD of a signed judicial order, setting a show cause hearing for Contempt of Court and requiring appointment of counsel.

b. Calendars: The Agency shall provide coverage for calendars if indicated in Attachment B, Calendar Attorney and Staff List. The calendars are defined as follows:

- i. Dependency Calendar: All initial 72-hour shelter care calendars in Seattle or Regional Justice Center (RJC) shall include the presence of an attorney.

- ii. **General Attorney of the Day (AOD):** The Agency will in good faith attempt to provide legal advice 24 hours a day seven days a week via beeper access and respond promptly to any accused adult or juvenile who is in the investigation phase or recently charged with a crime or detained on a civil matter within the jurisdiction of OPD. AOD for legal advice may occur both in RJC and Seattle. AOD includes a request from a defendant for substantial legal advice or a police agency to respond for line-up presentations. A call to the 24 hour beeper is calendar work not a case assignment.

Where substantial advice services are provided as a result of initial General AOD contact via beeper, credits can be requested as per Attachment A. "Substantial advice" includes legal services beyond providing of simple direct, one-time legal advice by phone or in person at a detention facility, and includes ongoing legal services preliminary to a formal appointment as counsel for prospective client.

Individual substantial advice assignments may also be appointed by the court or assigned by OPD, where the scope of work exceeds that described in the General AOD paragraph above.

- iii. **Felony Arraignment Calendar.**
 - iv. **Felony Sentence Modification Calendar:** The Superior Court Probation Modification Calendar.
 - v. **Juvenile AOD:** The Agency shall provide Juvenile Special Services which include making "morning rounds" in juvenile detention; lineups, detention reviews and arraignments; diversion counseling per RCW 13.40.080; and representing offenders as counsel until an attorney is formally appointed.
 - vi. **Juvenile First Appearance Calendar:** Each Agency representing juveniles shall provide representation on the Juvenile First Appearance Calendar. Representation of juveniles on this daily Juvenile Court Calendar shall include prior clients and/or unrepresented juveniles. Time spent on this calendar shall include preparatory work done concerning the juveniles listed on the calendar who do not appear because of expedited filing by the Prosecuting Attorney, release from detention prior to hearing, or other reasons for non-appearance.
 - vii. **King County Court Misdemeanor calendars include:** District Court Felony Investigation Calendar, Bench Warrant Return Calendar, and initial detention hearings for new misdemeanor charges.
- c. **Civil Contempt of Court practice area:** A civil contempt case shall include legal representation up to a maximum of three hearings, related solely to a contempt citation and shall be limited to cases where the

factual likelihood of loss of liberty arises from an act of King County or the State of Washington or a judicial act.

- d. Dependency practice area: Coverage for all dependency, termination, guardianship, dependency guardianship, contested private adoption termination, and Reinstatement of Parental Rights cases.
 - i. Dependency Case: A dependency case credit is given for the legal representation of a client from:
 - 1) The initial predispositional assignment through the dispositional hearing. Should an agreed order of dependency be entered on or before the date of the 30-day shelter care review, it shall be considered part of the dependency case. If the case is assigned to the Agency after the establishment of dependency and entry of the dispositional order, an initial case credit shall be given at the time of assignment; and
 - 2) The filing of a termination or guardianship petition to the setting of a termination or guardianship trial date. Should an agreed order of termination or guardianship be entered on or before the preliminary hearing, it shall be considered part of the termination or guardianship case.
 - 3) Appointment of counsel pursuant to RCW 26.33.110 for contested private adoption termination shall be considered a termination of parental rights appointment for credit purposes. The Agency shall not be required to have more than two open RCW 26.33.110 cases at a given time.
 - ii. Post-Dispositional Hearing: A dependency review shall include legal representation at any post-dispositional hearing or hearings related to the original dependency filing, excluding the initial 72 hour shelter care review, the 30-day shelter care review, and the dispositional hearing. Reviews included within this category shall include, but not be limited to: the initial progress review, six month review hearings, permanency planning hearings, new shelter hearings occurring post disposition, or other reviews or hearings set by the parties or by the court. If a review hearing is continued, additional credit shall not be allocated for the review unless the substantive issues within the review hearing change or substantial work is done. In the event that a court consolidates a family court matter with proceedings under a dependency case, pursuant to Local Juvenile Court Rules (LJuCR) 3.13, the Agency shall receive additional dependency review credit under this section for representation involving hearings in the consolidated matter.
 - iii. Dependency Trial/Termination or Guardianship Trial
 - 1) A dependency trial shall include:

- a) A fact finding for a dependency and the preparation for said fact finding or the entry of an agreed order of dependency and agreed dispositional order at the time of the scheduled dependency fact finding; or
 - b) Entry of an agreed order of dependency and any contested hearing or hearings related to the dispositional order pursuant to the agreed order, as described in RCW 13.34.110 (1) and (2). This does not include post-dispositional review hearings.
 - 2) A termination trial shall include:
 - a) A fact-finding on a termination petition or guardianship petition and the preparation for said fact finding; or
 - b) Entry of an agreed order regarding termination or guardianship petition at the time of the scheduled fact-finding.
- iv. If more than one petition is pending involving one client, only one case shall be allowed credit. If matters involving one client with multiple petitions are severed for separate proceedings on different petitions, credit shall be given for such hearings. In the event that a new petition is filed as to a parent involving a child not previously involved in prior proceedings and that petition is filed post-disposition of previously filed petitions, then a new case credit will be allowed on the newly filed petition.
- v. Reinstatement of Parental Rights Matters: Representation of a client from the time of appointment of counsel through completion of the matter to point of either completed reinstatement of parental rights, or dismissal of the Petition for Reinstatement of Parental Rights. To the extent that any hearings held in this matter are also concurrently a permanency plan hearing or review hearing in the related dependency matter, no additional review credits are given for those hearings for purpose of the related dependency matter.
- e. Felony practice area:
 - i. Felony Case: All legal representation related to a case filed in the Criminal Division of King County Superior Court by the King County Prosecutor's Office, alleging a violation of criminal law and having a maximum sentence of more than one year, through sentencing and any restitution hearing and as listed in Attachment A.
 - ii. Felony/Probation Review: A felony/probation review shall include legal representation at any hearing or hearings arising from a single notice of hearing subsequent to disposition of the

case. Areas within this category shall include, but not be limited to: probation reviews, revocations, early release, conditional release, safe-to-be-at-large, temporary release, medical release, and material witness hearings. A restitution hearing will be a review only if it is assigned to an agency other than the agency which represented the client at sentencing.

iii. Persistent Offender (I 593 C 1 L 94; RCW 9.94A.030(33); RCW 9.94A.570): Persistent offender is a defendant as defined by RCW 9.94A.030(33) and subject to sentencing pursuant to RCW 9.94A.570. The Agency shall provide documentation to OPD to verify a persistent offender case status.

iv. Complex Litigation: All death penalty homicide cases and all aggravated homicide cases. Aggravated homicide cases are considered death penalty cases until such time as decision is made by the Prosecuting Attorney not to file a notice of intention to seek death.

1) Complex litigation cases are "pending" until completion of the guilt phase and penalty phase/sentencing.

2) Aggravated homicide cases, in which the death penalty is not sought, shall occupy the portion of a full time attorney up to a maximum of one Full Time Employee (FTE) qualified at Senior Public Defense I level or above. Up to 0.5 FTE professional support staff will be assigned to each such case. Active Supervision will be assigned at up to 0.1 FTE.

3) Aggravated homicide cases, in which the death penalty is sought, shall occupy the portion of two full time attorneys, up to a maximum of two FTE attorneys, deemed necessary by the Agency to provide effective assistance of counsel. The attorney component shall comply with SPRC 2, Superior Court Special Proceedings Rules – Criminal, as well as one FTE qualified at Senior Public Defender I, or above. A professional support staff will be assigned up to one FTE. Active Supervision will be assigned at up to 0.2 FTE.

4) The Agency and the County understand that the portion of attorney(s) and professional support staff assigned to each complex litigation case may change from time to time as the case moves through the adjudication process. In the event that a case concludes sooner than scheduled in Attachment B, case credit allocation will be adjusted accordingly.

f. Involuntary Commitment practice area:

i. Initial Petition: An involuntary commitment case shall include any hearing on a petition for involuntary commitment under one cause number including a hearing for probable cause, or any

petition for additional commitment under the same cause number pursuant to RCW 71.05.280, except such hearings defined in (ii) and (iii) below.

- ii. **180-Day Petition:** Any involuntary commitment case that went to a 180-day hearing following a petition filed pursuant to RCW 71.05.320 shall be considered a separate case and shall be billed by client name and shown separately. When a new docket number is assigned and the first court appearance is a 180-day hearing, the Agency will receive case credit and payment for either the assignment of the new docket number or the 180-day hearing, but not both.
 - iii. **Involuntary Medication Hearing:** A hearing held pursuant to a petition for involuntary administration of medications or electroconvulsive therapy shall be considered a separate case.
 - iv. An alcohol involuntary commitment proceeding filed pursuant to RCW 70.96A including all hearings under the same cause number shall be considered one case.
 - v. A drug-related involuntary commitment filed pursuant to RCW 70.96A including all hearings under the same cause number shall be considered one case.
- g. **Juvenile Offender practice area: Coverage for all juvenile cases filed in juvenile court, including Diversion Calls.**
- i. **Juvenile Offender Case:** A juvenile offender case includes any criminal charge filed by the King County Prosecutor's Office in King County Juvenile Court. A restitution hearing is included within the initial case credit.
 - ii. **Juvenile Offender Modification/Review:** A juvenile offender modification/review shall include a hearing or hearings related to the allegations contained in the notice of the modification/review. In the event that the juvenile respondent has several notices of modification/review because of different cause numbers and all such modifications/reviews are heard at a single hearing, then such hearing shall constitute one completed juvenile offender modification/review.
 - iii. **Juvenile Offender Restitution Review Hearing:** A juvenile offender restitution review hearing consists of a hearing or hearings related to the subsequent modification of restitution schedules set by the court for the particular juvenile offender. In the event that the juvenile has several pending restitution hearings and such hearings are all heard at the same hearing, then such completed hearing shall constitute one completed restitution review hearing.
- h. **Misdemeanor practice area:**

- i. Misdemeanor Case: Any criminal case, including traffic misdemeanors, filed by the King County Prosecutor in the District Courts.
 - ii. Misdemeanor Appeal: A misdemeanor appeal involves filing the notice of appeal, if necessary, perfecting the record following the filing of the notice of appeal, preparation of the transcript pursuant to Rule 6.3a Rules for Appeal of Decisions of Courts of Limited Jurisdiction (RALJ), preparing such briefs and memoranda as are required, arguing the case in Superior Court, and handling such paperwork as the Superior Court's decision and orders direct.
 - iii. Misdemeanor Writ: A writ involves filing notice, perfecting the record, preparing such briefs and memoranda as required, arguing the case in Superior Court and handling such paperwork as the Superior Court's decision and orders direct.
- i. Sexual Predator practice area: Legal representation for indigent persons assigned by OPD for cases filed under RCW 71.09, civil commitment petitions filed by the King County Prosecuting Attorney or the Attorney General's Office, subject to such conditions stated in the current Program Agreement, and General Terms Agreement between the County and the State of Washington Department of Social and Health Services (DSHS) from the effective date of these agreements, and directly invoice to and be reimbursed by DSHS at a rate determined by DSHS or as ordered by the Court.
 - j. Specialty Court practice area:
 - i. Specialty Court/Drug Court: Any criminal case filed into King County Superior Court Drug Court. Staffing is determined by a separate agreement, which is incorporated by reference herein.
 - ii. Specialty Court/District Mental Health Court includes: Any case filed into King County District Mental Health Court. Staffing is determined by a separate agreement, which is incorporated by reference herein.
2. Case Credit: Case credit is a unit of work. The total number of units that an attorney is expected to perform is listed in the case credit workloads of Section III. Program Requirements, of this Exhibit. Attachment A of this Exhibit defines the Case Credit Application and parameters for additional credit in extraordinary cases.

Extraordinary Case Credit: Extraordinary case types including Juvenile Felony Offender, Contempt of Court, Dependency, Termination of Parental rights, RCW 26.33.110 contested adoption termination, Reinstatement of Parental Rights, Murder, Persistent Offender, and all Adult Felony cases shall be given extra credits if the nature of the case requires such extra credits, based upon a written application from the Agency. Other case types may be approved for extraordinary credit at the discretion of OPD. Factors entering into the awarding of extra credits shall be as according to Attachment A.

3. **Criminal Case:** A case is any one charge or series of related charges filed against one defendant/respondent in a single charging document or in the case of misdemeanors a series of charges under several charging documents, set for one court hearing that will ultimately lead to one disposition.
- a. If a related series of charges is defined herein as a single case is subsequently set for separate disposition hearings or trials, the Agency may request additional credit for each case, which is severed from the consolidated case.
 - b. If a new case is filed on a separate incident after case has been assigned, and a new count is charged but not a new court case number, the Agency may request additional credit for each case similarly filed. An incident is defined as a criminal charge alleged to have occurred on or about a specific calendar day. Multiple offenses charged as occurring on or about the same date are considered a single incident. A maximum of three credits shall be allowed, if requested by the Agency, per charging document regardless of the number of incidents alleged. Agency may apply for Extraordinary Case Credit if appropriate.
 - c. Criminal charges alleged to have occurred on indeterminate dates or during a specified range of dates (e.g. on or between specific dates) are considered one incident. The Agency may present documentation to OPD to demonstrate that separate and discreet dates of incident were intended. Documentation should include such portions of pre-trial discovery to justify claim for separate incidents. In the event that such separate incidents are determined, a maximum of three credits shall be allowed, if requested by the Agency, per charging document.
 - d. A completed case involves all necessary legal action from arraignment through disposition. This includes the filing of a notice of appeal upon the client's request, application to proceed in *forma pauperis* on appeal, and a motion for appointment of appellate counsel.
 - e. A case remanded to the trial court for proceedings following appeal is a new case credit. The filing of an appeal (interlocutory appeal which is accepted for review by the appellate court or post-dispositional) closes the case for credit purposes.
4. **Criminal Case Disposition:** Case disposition shall mean the dismissal of charges, the entering of an order of deferred prosecution, an order or result requiring a new trial, imposition of sentence or deferral of same, or dispositional continuance and any other hearing on that cause number that occurs within 45 days of sentence, entry of an order for deferral of sentence, or dispositional continuance by District Court. Sentencing includes completed hearing on establishing restitution order. A motion to modify restitution shall be considered for additional credit if the motion occurs after 180 days.

A restitution hearing ordered at the time of original disposition shall be included as part of the case credit as defined by this disposition description. It shall include the filing of a notice of appeal, if applicable. It shall not include a felony or misdemeanor probation review unless such review occurs within 45 days of disposition. Additionally, it shall not include any hearing ordered at the

conclusion of a deferred sentence unless such hearing occurs within 45 days of sentencing.

5. **Indigent:** An indigent defendant is a person determined indigent by OPD or the Court as being eligible for a court-appointed attorney, pursuant to RCW 10.101, 13.34.090, and OPD policy. Defendants may be considered assigned until a screening for indigency is completed, pursuant to RCW 10.101.020(4). Defendants may be required to be re-screened if their financial situation changes or at each 180 days of Agency representation. If a defendant is found to be not indigent, OPD will inform the Agency and court. In the event the court removes the Agency from assignment or orders the Agency to withdraw as appointed counsel, credit for such representation by the Agency is determined by the terms of this Contract, including the relevant sections of Attachment A.
6. **Legal Services:** Legal service is legal representation provided by an individual licensed attorney, and associated professional support staff to an individual client, pursuant to a case assignment or court appointment. The attorney will be required by the Agency to satisfy the Code of Professional Responsibility, the law of the State of Washington and the United States in the full discharge of the duties to each individual client under this Contract.
7. **Professional support staff:** Investigators, social workers and paralegals.
8. **Supervision:** An attorney with significant experience who is capable of actively monitoring an attorney's work product, caseload management, and relationship with clients and is capable of providing legal advice and guidance in other areas relevant to assuring high quality staff attorney performance. The Agency will provide active supervision for each staff attorney, in the ratio of one supervisor per ten staff attorneys.

III. PROGRAM REQUIREMENTS

A. Services

1. **Case Credit Allocation and Case Assignment:**
 - a. OPD shall make reasonable efforts to maintain the Agency at the total case credit allocation and case assignment as shown on Attachment B of this Exhibit, for each quarter of the year. The quarterly case credit amounts in Attachment B are provided for planning purposes. OPD shall make reasonable efforts to distribute cases beyond variance consistent with the case credit allocation in Attachment B of this Exhibit and paragraph b. below. The variance in case distribution does not apply to calendars, specialty court agreements, complex felony cases, or Sexually Violent Predator cases.
 - b. The Agency shall accept case assignments within contracted subject areas, including case assignments above the projected variance levels. Agency refusal to accept an individual case assignment within contractual subject areas shall not in and of itself be considered a material breach of this Contract, however the County may determine such refusal requires Agency corrective action. The County shall pay

the Agency for work in excess of the variance levels according to Section IV of this Exhibit.

- c. The Agency shall accept all complex litigation cases as determined by OPD, after consultation with the Agency concerning capacity.
 - d. If the Agency has begun delivery of legal services and the defendant/respondent absconds for a period of 180 days or more, upon re-apprehension, the allocation of a new case credit shall be determined by OPD.
 - e. If the Agency is assigned to a case prior to arraignment, has not provided legal services, and the defendant fails to appear for arraignment, the case shall be returned to OPD within 30 days or as agreed with OPD, and the Agency shall be debited.
 - f. If, after initial assignment, additional charges are filed under the same cause number against the same defendant/respondent, and said charges arise out of a different allegation or series of allegations unrelated by transaction to the first charges, then additional case credit shall be granted according to paragraphs II.C.2, 3, and 4 above.
 - g. The Agency may be appointed by the court as standby counsel in pro se cases. If such appointment is made, the Agency shall receive one case credit, less previous credit assigned for case. The Agency is not necessarily expected to utilize its professional support staff for pro se case work. If professional support staff work is requested by the pro se defendant, the Agency may opt to reduce its credit allocation by 0.1 per case credit allocated by not utilizing Agency professional support staff. In the event that the Agency elects to not provide professional support staff services, then it is the responsibility of the pro se defendant to comply with OPD Expert Services protocols regarding requests for any such services as may be necessary. Standby counsel shall provide such assistance and advice as may be ordered by the court and otherwise as consistent by case law and other legal requirements, and applicable standards of attorney representation and attorney conduct, including pro se requests for expert services.
 - h. The Agency shall electronically file a Closed Case Report (Attachment D) each month with OPD which shall include all information requested in the report for the month indicated and be submitted to OPD no later than 20 days following the last day of the previous month. A case is considered closed for further credit for attorney time expended after 30 days past sentencing, or a dispositional order is filed, or upon filing of a Notice of Appeal, unless an additional court order appoints counsel.
2. Funds for payment for expert services are not included in this Exhibit. Requests for appointment for expert service shall be made following OPD procedure for allocation of expert services. The Agency must assure that its staff follows the OPD expert procedures, as agreed with OPD.
 3. The Agency shall fully participate as requested by the County in Superior Court and OPD planning and responsibilities for providing services in the event of a

natural disaster, a major disruption to court processes, or a pandemic. The Agency shall develop and maintain disaster plan protocols which shall include a provision for daily contact with OPD and the Courts to verify court calendars requiring counsel presence. The parties acknowledge that all such plans presume the continued ability to communicate between the Agency and OPD. OPD shall assist the Agency in coordination with the courts and general implementation of the disaster plan.

The Agency shall submit within six months of the execution of the Contract the necessary plans, procedures and protocols to respond to and recover from a natural disaster or major disruption to agency operations such as a work stoppage; and continue operations during a prolonged event such as a pandemic. The plans shall be consistent with written County disaster plans for purposes of continuation of court business in the event of a disaster.

B. Practice Standards and Records

1. The Agency shall require that all attorneys, professional support staff and supervisors maintain contemporaneous records of all legal services provided on a specific case. The records shall provide a factual description of the work done and shall be sufficiently detailed to allow monitoring of legal service activity by OPD.
2. Upon closing a case, all attorney, professional support staff and supervisor files associated with the case shall be cross referenced and accessible as a whole for OPD monitoring.
3. The Agency shall maintain professional practice standards in providing a level of legal service that does not fall below the minimum professional standards and RPCs of the Washington State Supreme Court, the Washington State Bar, the National Legal Aid & Defender Association, and any applicable case law and court rules that define the duties of counsel to their clients. The Agency shall formally adopt the internal Agency practice standards as submitted to OPD February 1, 2006, and shall include a procedure for monitoring compliance with the standard. Case credit workload standards shall be according to paragraph III.B.14. below.
 - a. Attorney practice standards, include but are not limited to:
 - i. Lawyer-client relationship, initial case actions, investigation and preparation, preliminary hearings; disposition without trial; trial; post conviction or fact finding and any other areas of attorney practice deemed appropriate by Agency management or Board.
 - ii. Attorney use of professional support staff services and expert services.
 - b. Professional support staff service practice standards.
 - c. Practice standards for supervision of attorneys and professional support staff services.
4. The Agency agrees that, within available resources, reasonable efforts will be made by the Agency to continue the initial attorney assigned to a client

throughout any case in which representation is undertaken. The Agency is not prohibited from rotating attorneys through various Agency divisions or from assigning a single attorney to handle various aspects of legal proceedings for all indigent persons where such method of assignment is the most reasonable method of obtaining effective legal representation for indigent persons.

5. The Agency agrees that a member of the Agency staff shall visit any assigned in-custody criminal defendant, in-custody civil commitment, or dependency clients, and obtain basic contact and other fundamental intake information for a bond hearing within one business day from notification to the Agency of the assignment of the case and the in-custody status of the client, and/or within one business day upon notification of transport to a local detention facility. This provision applies to clients in custody at any facility within the King County jail. If a client is in custody in a non-County jail, the Agency shall make contact within three business days of receiving the assignment.
6. The Agency agrees that an attorney shall make contact with all assigned persons within five working days from a case assignment, or in rare occurrences where this is not achieved the Agency shall document reasonable efforts to make said contact.
7. The Agency agrees that a preliminary written response to any written complaints from OPD concerning services provided by the employees of the Agency or the Agency itself shall be submitted to OPD within three working days of the date the complaint is received by the Agency Director or the Director's designee. Written complaints include email communications from OPD; email response date will be provided.
8. Upon assignment of any client charged with a criminal case to an Agency, the Agency shall make diligent and reasonable efforts to obtain discovery within five business days of the assignment, whether initial or subsequent, on any case. In all cases, discovery shall be reviewed as soon as possible and in no event later than five business days after receipt for purposes of determining any conflicts of interest. The Agency shall notify OPD immediately and no later than 14 calendar days from assignment without good cause shown, of any conflict of interest as defined by the Washington State Rules of Professional Conduct. The Agency shall state the basis when possible, as court determines, for the conflict in its written notification.
9. The Agency shall establish and enforce policies and procedures to ensure that attorney time and other Agency resources funded by this Contract shall be for work, which is the subject of this Contract.

The Agency shall establish policies and procedures for pro-bono work provided by staff of the Agency. These policies and procedures shall assure that any such pro bono work is not provided to the exclusion or detriment of legal services that are the subject of this Contract.

10. Attorney Professional Support Staff

The Agency shall provide sufficient professional support staff, including investigators, social workers and paralegals to provide for effective assistance of counsel.

11. Minimum Attorney Qualifications

- a. Attorneys shall have the requisite qualifications for the cases to which they are assigned by the Agency, consistent with Washington State Bar Association (WSBA) Standards for Public Defense Services, Standard Fourteen, Qualifications for Attorneys, as adopted in 2007 and as may be amended by WSBA during the Contract period.
- b. Each staff attorney representing any client assigned by OPD shall work under the supervision of a supervising attorney employed by the Agency. Such supervision shall provide the staff attorney with sufficient resources so the attorney will be able to handle cases on his/her own. The employees of the Agency are not employees of the County and the County will not provide supervision to any of the Agency's employees.
- c. The Agency may choose to use Rule 9 Interns or Rule 8 attorneys, as allowed by Washington State Bar Association regulations.

12. Attorney/Professional Support Staff Evaluation

The Agency director, or his/her designee, shall evaluate the professional performance of each individual Agency attorney and professional support staff member annually. Attorney evaluations shall include: quality of case preparation, compliance with the requirements of this Contract, monitoring of time and caseload records, review of case files, and in-court observation.

Professional support staff evaluations shall be sufficiently comprehensive to assess the quality of the actual work performed.

The Agency shall keep a written record of all required performance evaluations.

13. Attorney/Professional Support Staff Training

The Agency shall provide access to sufficient training to support attorney and professional support staff performance of duties under this Contract. The Agency shall maintain all necessary records to assess the adequacy of the training. A Continuing Legal Education (CLE) approved by the Washington State Bar Association is presumptively adequate.

At a minimum during the Contract period, the Agency shall require each attorney to attend at least seven WSBA approved credits of CLE in a practice area under this Contract. Each Agency attorney must attend training approved by WA State OPD, pursuant to RCW 10.101.050 and as posted on WA State OPD website, at least once per calendar year. Each Agency attorney also shall satisfy the minimum requirements for practicing law in the State of Washington as determined by the Washington Supreme Court.

14. Case Credit Workload Guidelines

The County shall review Agency case credit workloads, case assignments, standards, and support staff/attorney ratios for each area of cases to assess compliance with the requirements of this Contract.

The total amount of reimbursement included in this Contract resulted from the application of the Public Defense Payment Model approved by the King County Council by Motion 12160 on July 18, 2005. Pursuant to the policies stated in Motion 12160, the allocation for each case area was calculated to provide funding for public defenders at parity with similarly situated attorneys in the Office of the Prosecuting Attorney. The Agency's staffing plan may be reviewed by OPD to verify that an attorney's experience level meets or exceeds required experience for case practice area, and placement within the salary schedule is reasonable. The Agency agrees to comply with the following average annual case credit work loads per attorney per case type:

Supervisors	0
Felony	150
Complex	150
593	150
King County Misdemeanor	450
Juvenile*	330
* KCC Motion supplemented by WA State funds (see Att C of this Exhibit) to allow effective caseload of 250	
Dependency	180
Becca	(refer to IV.H. of this Exhibit)
Contempt of Court	225
Involuntary Treatment Act (ITA)	410

A supervisor, including a managing director or assistant director, may provide minimal representation to clients under this Exhibit solely for the purpose of addressing management issues, emergencies or caseload overflow beyond the projections. OPD shall be notified of primary representation by supervisory staff constituting a caseload that exceeds available one to ten ratio of supervisory availability.

15. The Agency agrees to abide by the OPD Withdrawal procedures (Attachment E) when declining a case or withdrawing from a case because of a conflict of interest. Agency may withdraw only pursuant to applicable court rules and RPCs. Agency attorney shall promptly notify the court of any conflict of interest or any other reason requiring withdrawal from a case assigned under this Exhibit. The Agency shall submit the Withdrawal form to OPD and the case will be re-assigned by OPD upon receipt of signed Court Motion or if case is an early assignment (pre-court appointment) from OPD, OPD may re-assign the case in advance of Court appointment and/or Motion. Credits shall be applied according to the terms of this Exhibit, including Attachment A.

16. The Agency shall report all extraordinary occurrences to OPD in accordance with the Extraordinary Occurrences Policy and Procedure, and cooperate with any OPD extraordinary occurrence review. The Agency shall adopt an Agency specific extraordinary occurrence policy. The requirement to report to OPD does not replace reporting requirements by other entities.

17. The Agency shall have a process for the filing and review of complaints that are brought to the Agency's attention by clients, OPD, or other criminal justice system staff. The Agency shall establish an internal complaint procedure that is accessible to all clients, in accordance with RCW 34.05, 49.60, RPCs, and the OPD Client Complaint Services Policy and Procedure. The Agency shall maintain a file system for reliable report backup of each complaint.
18. The Agency agrees to abide by the terms of the OPD Attorney Supervision Policy and Procedures.
19. The Agency shall have an Information System (IS) that can report accurate data to OPD, and shall comply with the OPD IS Policy and Procedure. The Agency shall have functional personal computers using a Windows Operating System version 2000 or above and shall be connected to the Internet with the following supports:
 - a. The Agency shall have at least one trained primary and one trained backup on-site IS support person who has training on Basic Administration of Windows 2000, and other basic software training.
 - b. The Agency shall notify OPD, in writing, of staffing changes (i.e. new hires, transfers, and terminations) for those staff directly responsible for data reporting and IS maintenance.
 - c. If a virus attacks an Agency computer, Agency response must be immediate (i.e. within 15 minutes) to take the computer off line and other appropriate action.

IV. COMPENSATION AND METHOD OF PAYMENT

- A. The Agency shall be paid monthly as provided in Attachment C of this Exhibit except as paragraph IV B. applies. The Payment Schedule shall pertain to all cases assigned to the Agency from January 1, 2008 through December 31, 2008. The Agency shall submit reports in a format approved by the County, as stated in Section V. Reporting Requirements of this Exhibit. The reports are due within ten days after Agency receipt of the OPD Case Credit Certification Report.
- B. Payment shall be made monthly, subject to performance requirements being met and upon completion of scheduled corrective action requirements noted in the OPD 2007 site visit review and the Agency plan for corrective action. For each corrective action due date missed by the established due date, one percent of the subsequent month's payment will be withheld until action is completed or report is received and accepted by the County.
- C. Payments may be made for extraordinary expenses that are in addition to those payments shown in Attachment C, Payment Schedule. Extraordinary expenses shall be approved in writing in advance of the expenditure by OPD.
- D. In the event that workload demand exceeds the projected levels, the Agency shall accept case assignments and case credits above the variance levels on a monthly basis. OPD will monitor the distribution on a cumulative monthly basis to ensure that a reasonable distribution of cases has been maintained.

- E. For quarterly and annual payment purposes, the variance shall be no more than five percent, for all case areas except felony cases, which shall have a variance of no more than two-and-one-half percent. These variance percentages will be applied to the projected caseload to establish the variance range.
- F. Quarterly reconciliation: At the end of each quarter, OPD will evaluate the case credit accumulation for each Agency for each case type. Action taken will be as follows:
1. The actual quarterly caseload for each type of case area, as shown in the quarterly Certified Statistics will be compared to the actual variance range, for each practice area. Variance does not apply to calendars, specialty court agreements, or Sexually Violent Predator cases.
 2. If the Agency's actual quarterly caseload falls within the high and low values of the variance, an adjustment to the reimbursement will not be made.
 3. If the Agency's actual quarterly caseload falls outside of either the high or low values of the projected variance range, an adjustment to the payment may be made.
 4. If a quarterly reconciliation results in payment due to the Agency from the County, the Agency may, at the Agency's option, defer such payment to a later month in the Contract year.
 5. If the quarterly reconciliation results in payment due to the County from the Agency, the County may, at the County option, defer such payment to a later month in the Contract year.
- G. Year end reconciliation: The final payment will be the result of a reconciliation of actual performance to Contract specifications. The reconciliation will be conducted as follows:
1. The annual variance percentages outlined in Section III. Program Requirements will be applied to the projected caseload to establish the variance range.
 2. The actual annual caseload for each type of case will be compared to the variance range for each type of case, except for complex felony cases, calendars, specialty court agreements, or Sexually Violent Predator cases.
 3. If the Agency's actual annual caseload falls within the high and low values of the variance, an adjustment to December reimbursement will not be made.
 4. If the Agency's actual annual caseload falls outside of either the high or low values of the projected variance range, an adjustment to the final payment will be made.
- H. Becca Cases: The Agency shall be paid by OPD for CHINS, ARY, and Truancy legal services from funds provided by the State of Washington through King County Superior Court, Juvenile Court Services, and such additional funds as may be made available by King County.
1. Truancy. Truancy cases will be counted as one credit for the filing of a truancy contempt of court where the right to counsel attaches. No additional credits will be given for review hearings.

2. ARY/CHINS. ARY and CHINS cases will be counted as one credit for new assignments on a petition for ARY or CHINS. The initial case credit will include two review hearings. Review hearings after the first two on that petition will earn one third (.33) credit per review.
 3. Review hearings. All hearings subsequent to the hearing in which the ARY or CHINS fact finding is completed and in which disposition of the petition is ordered, if ordered in a separate hearing, will be considered a review. Any contempt hearing ordered on the original petition post disposition will be considered a review credit, if the matter is handled within the proceedings relating to the ARY or CHINS petition. Hearings relating to the contempt in the ARY or CHINS proceeding which occur post disposition of the contempt matter will be considered a review hearing.
 4. Truancy credit load limit. For purposes of this contract, Truancy cases will have a case credit load limit of 375 credits per FTE attorney per year.
 5. ARY / CHINS credit load limit. For purposes of this contract, ARY and CHINS cases will have a case credit load limit of 250 credits per FTE attorney per year.
 6. A variance of five percent applies to Becca cases in total, as counted in aggregate in this Contract. Site specific estimates included in Attachment B are for Agency management purposes only.
 7. The Agency agrees to provide attorneys for the same court sessions and calendars in 2008 as it did in 2007.
- I. Sexual Predator cases: The Agency shall be paid by the State of Washington for cases filed under RCW 71.09 and assigned to the Agency by OPD at a rate determined by DSHS or as ordered by the Court. Agency reimbursement shall be based on submission of expenditure reports and an invoice to DSHS in a format approved by DSHS. OPD shall apply its policies and procedures, as amended and posted on its website, to review and approve or deny requests from Agency counsel for use of Expert Services in 71.09 cases. Such authorization for Expert Services shall be made at the sole discretion of OPD. Upon approval or denial of counsel's request for Expert Services, OPD shall notify counsel. Per OPD policy, defense counsel may appeal an expert service denial to the court. Expert service reimbursement shall be invoiced to and provided directly by DSHS.
- J. Prepayments
1. The Agency shall ensure that it has sufficient funds to complete prepaid cases assigned but not completed at the end of the Contract period. The Agency must report its calculated prepayment retention amount and cost estimate, include the method of calculation, and provide a conclusion about whether the funds available would cover all costs associated with completing the cases assigned and prepaid. Not having an adequate reserve shall not be cause for a material breach of contract, but may require Agency corrective action.
 2. In the absence of a precise calculation of prepayments by the Agency, the County shall estimate the sufficiency of funds using the following formula:

For all felony, misdemeanor, initial dependency assignments, and juvenile offender cases assigned during October, November, and December that remain open at year-end, it is assumed that October cases are 75 percent completed, November cases are 50 percent completed, and December cases are 25 percent completed. For dependency cases it is assumed October cases are 15 percent completed, November cases are ten percent completed, and December cases are five percent completed.

The estimation shall be the result of calculating the number of open cases for each month by the corresponding percentage of uncompleted work, and then determining the sum of the uncompleted case count by the per case revenue amount to determine the sufficiency of funds.

V. REPORTING REQUIREMENTS

Compliance with the terms of this Exhibit requires the following reports, in a format approved by the County, to be submitted at the times indicated in the chart below.

Report Title	2008 Due Date
Closed Case Reports Persistent Offender (593) Monthly Case Report Additional Credit forms Monthly Expenditure Reports Complex Litigation time sheets Extraordinary Case Credit requests	Monthly, or more frequently if necessary
Year-end Attorney Case Assignment Report	January
Agency Disaster Plan	June
Annual Financial Statements, IRS Form 990, Audit Report including management letters.	August
Additional summaries, reports or documents, corrective actions directly related to Contract performance, as requested by OPD with reasonable notice.	Varies

ATTACHMENT A

Case Credit Application Schedule

Type of Case	
felony	
One completed case	One case credit
Atty/Day or substantial advice	.10 case credit
Atty/Day or substantial advice in the King County Detention Facility	.20 case credit
Probation, other reviews, or sentencing only	.33 case credit
Assignment for Motion to Withdraw Guilty Plea or a Motion for New Trial based on a claim of ineffective assistance of counsel	One case credit
Murder 1	Two case credits upon assignment
Murder 2	Two case credits upon assignment
Persistent Offender (593)	<p>One case credit upon assignment, less previously assigned felony credit. The Agency is eligible for additional case credit for each additional 12.1 hours or portion thereof of attorney time on the case according to the Extraordinary Cases section of this Attachment A. The Agency shall report monthly to OPD the total attorney time in each persistent offender case in a format consistent with Attachment F categorizing attorney hours. It is understood that the Agency director or the director's designee will review the status of all pending persistent offender cases in the Agency at least monthly and will discuss the cases with the attorneys representing the clients. Such review will include the status of investigation, preparation and presentation of mitigation packages, legal and factual issues in the case, the client's physical and mental status, and any plea bargaining offers.</p> <p>This reimbursement method shall be in place until such time as the King County Council approves, by motion, a change in reimbursement methodology, and such time when the Council approved change is amended to this Contract.</p>
Felony Bench Warrant during case	One case credit if more than 180 days has passed since the date of the bench warrant and if the bench warrant was on a new case assignment; or 0.33 case credit if warrant was a probation review or other hearing valued at 0.33 credit.

Type of Case	
Case transferred to another agency, assigned counsel, or retained counsel	Substantial advice credit if case is not completed prior to transfer and if Agency provides to OPD satisfactory justification for credit. In the event that award of substantial advice credit alone results in a substantial financial hardship to the Agency, the Agency may request additional credit. Factors to be considered for additional credit include advanced stage of proceedings (e.g. set for plea, set for or approaching trial date, substantial amount of work expended).
Case transferred to drug court	One case credit
Complex Litigation	
Capital cases	Two FTE attorneys; 25 complex litigation case credits per month maximum plus support staff as approved.
Aggravated Homicide	One FTE attorney; 12.5 complex litigation case credits per month maximum.
King County Misdemeanor	
One completed case, King County District Court	One case credit
District Court review, revocation, re-sentencing or other hearing	One case credit
One District Court expedited felony	One case credit
Misdemeanor Appeal	Four case credits
Misdemeanor Writ	Three case credits
Atty/Day or substantial advice; excludes misdemeanor beeper calendar matters listed in Attachment B and other calendar representation.	0.10 case credit
Atty/Day or substantial advice for In-custody clients; excludes misdemeanor beeper calendar matters listed in Attachment B and other calendar representation.	0.20 case credit
Misdemeanor	
One completed case	One case credit
Decline hearing	One case credit

Type of Case	
Reviews	0.33 case credit
Atty/Day or substantial advice	0.10 case credit
Juvenile Dependency Act	
A dependency case	One case credit
Post Disposition Review Hearing	0.40 case credit
Dependency trial	0.50 case credit
Termination trial	One case credit
Atty/Day for substantial advice	0.10 case credit
Restoration of Parental Rights	
Child and/or parent may be represented	One case credit
Civil Contempt	
From show cause initial assignment hearing up to and including two contempt reviews	One case credit
Subsequent reviews	0.33 case credit
Legal Guardianship of Siblings at Risk of Abuse	One case credit for one completed case – petition through closure.
EA	One case credit
High Risk Court	Calendar funding
Child Mental Health Court	Calendar funding
Other Court Services	
New statutory mandates	Case types not contemplated by this Contract arising from legislation with effective dates after January 1, 2007 shall be assigned by OPD and accepted by the Agency subject to agreement on the credit to be given.

Type of Case	
Extraordinary Cases	<p>Extraordinary Juvenile Felony Offender, Dependency, Termination of Parental Rights, RCW 26.33.110 contested adoption termination, Reinstatement of Parental Rights, Murder, Persistent Offender, and all Adult Felony cases shall be given extra credits if the nature of the case requires such extra credits, based upon a written application from the Agency for additional credits and negotiation between OPD and the Agency. Factors entering into the awarding of extra credits include, but are not limited to: seriousness of the charges; amount and complexity of evidence; number of witnesses; unusual legal issues; number of defendants; whether there is a plea, bench trial or jury trial; number of pre-trial motions or hearings needed; severity of the consequences; and actual length of trial.</p> <p>The Agency application must be specific about the work to be done or completed to date, the estimated length of time to perform the work, and the personnel that will be assigned to perform the work. Initial OPD response to the Agency, including requests for additional information, shall be made within five business days from OPD receipt of Agency application.</p>
Credit for cases where the Agency withdraws due to a conflict of interest	<p>When the Agency has reviewed discovery and reported to OPD its withdrawal for reason of conflict and requested credit for time expended, OPD shall review the Agency's request for credit, including the reason given for withdrawal and may grant appropriate credit. Should such credit be denied, OPD shall inform the Agency of the basis for denial.</p>
Pro Se/Standby Counsel	<p>One case credit if professional support staff work is performed by the Agency and requests for appointment of professional support staff at public expense outside of the Agency are not submitted to OPD. If professional support staff work is requested by the pro se defendant, the Agency may inform OPD that it is opting to reduce its credit allocation by 0.1 per attorney credits assigned in the case by not utilizing its professional support staff.</p>

ATTACHMENT B

Agency Case Credit Allocation and Cases Assigned Estimate for January - December 2008

Case Category	Total Agency Case Credit Allocation	Agency's % of Total OPD Case Credits	1st Quarter	2nd Quarter	3rd Quarter	4th Quarter
<i>Felony & 593s</i>	3,596.0	32%	899.0	899.0	899.0	899.0
<i>Complex</i>	150.0	25%	37.5	37.5	37.5	37.5
Total Felony	3,746.0		936.5	936.5	936.5	936.5
KC Misdemeanor	1,207.0	14%	302.0	302.0	302.0	301.0
Juvenile Offender	1,228.0	31%	307.0	307.0	307.0	307.0
Dependency	973.0	31%	243.0	243.0	244.0	243.0
Contempt of Court		0%				
Involuntary Treatment Act	2,129.0	100%	532.0	532.0	532.0	533.0
Becca (new cases) - DYS	34.0	2%	9.0	9.0	7.0	9.0
TOTAL	9,317.0	28%	2,329.5	2,329.5	2,328.5	2,329.5

2008 Calendar Attorney and Staff List

Case Area	KCCF	RJC	Calendar	Agency	Day	Time	Atty	Staff	Supv
FELONY	X		In-of-Custody SRA calendar	TDA	Th-Fri	1-5:00 pm	0.20	0.50	0.02
	X		Arrestment calendar	TDA	Mon-Fri	9:00 - noon	0.50	0.25	0.05
	X		Felony Investigation calendar	TDA	Mon-Sat	1-5:00 pm	0.60	0.25	0.06
KC MISDEAMEANOR		X	Domestic Violence Court calendar	TDA	Mon-Fri	8-5:00 pm	1.00	0.25	0.10
	X		Seattle District Court	TDA	Wed	9-5:00 pm	0.20		0.02
JUVENILE	X		1st appearance & diversion calls	TDA	Mon-Fri	9:00 - noon	0.50		0.05
DEPENDENCY		X	Attorney of the Day (AOD) 72- hour Shelter Care	TDA	Mon-Fri	8-noon	0.50		0.05
	X		Attorney of the Day (AOD) 72- hour Shelter Care	TDA	Mon-Fri	8-noon	0.50		0.05
SUB-TOTAL TDA							4.00	1.25	0.40

Beeper Duty \$11,549
 (\$30/day * 365 days)+ 2008 COLA

ATTACHMENT C

Payment Schedule

This Payment Schedule shall pertain to all cases assigned to the Agency from January 1, 2008 to December 31, 2008. In 2008, the Agency shall be paid the following monthly amounts for cases and special services:

2008	Jan Payment	Feb Payment	Mar Payment	Apr Payment	May Payment	Jun Payment
Felony (regular & 593s)	334,364	334,364	334,364	334,364	334,364	334,364
Felony (complex) ^a	13,947	13,947	13,947	13,947	13,947	13,947
Juvenile	51,096	51,096	51,096	51,096	51,096	51,096
King County Misdemeanor	36,942	36,942	36,942	36,942	36,942	36,942
Involuntary Treatment Act	70,684	70,684	70,684	70,684	70,684	70,684
Dependency	75,247	75,247	75,247	75,247	75,247	75,247
Calendar Staffing	47,592	47,592	47,592	47,592	47,592	47,592
Agency Admin & Overhead:						
Administration	50,863	50,863	50,863	50,863	50,863	50,863
Indirect Cost	29,674	29,674	29,674	29,674	29,674	29,674
Rent	57,038	57,038	57,038	57,038	57,038	57,038
Total Agency Admin & Overhead	137,575	137,575	137,575	137,575	137,575	137,575
Racial Disparity Project	3,750	3,750	3,750	3,750	3,750	3,750
Becca	1,465	1,465	1,465	1,465	1,465	1,465
Juvenile 10.101 ^c	17,742	17,742	17,742	17,742	17,742	17,742
TDA TOTAL	790,404	790,404	790,404	790,404	790,404	790,404

2008	Jul Payment	Aug Payment	Sep Payment	Oct Payment	Nov Payment	Dec Payment	TOTAL Jan-Dec 2008
Felony (regular & 593s)	334,364	334,364	334,364	334,364	334,364	334,389	4,012,393
Felony (complex) ^a	13,947	13,947	13,947	13,947	13,947	13,952	167,369^b
Juvenile	51,096	51,096	51,096	51,096	51,096	51,119	613,175
King County Misdemeanor	36,942	36,942	36,942	36,942	36,942	36,924	443,286
Involuntary Treatment Act	70,684	70,684	70,684	70,684	70,684	70,688	848,212
Dependency	75,247	75,247	75,247	75,247	75,247	75,251	902,968
Calendar Staffing	47,592	47,592	47,592	47,592	47,592	47,598	571,110
Agency Admin & Overhead:							
Administration	50,863	50,863	50,863	50,863	50,863	50,858	610,351
Indirect Cost	29,674	29,674	29,674	29,674	29,674	29,675	356,089
Rent	57,038	57,038	57,038	57,038	57,038	57,036	684,454
Total Agency Admin & Overhead	137,575	137,575	137,575	137,575	137,575	137,569	1,650,894
Racial Disparity Project	3,750	3,750	3,750	3,750	3,750	3,750	45,000
Becca	1,465	1,465	1,465	1,465	1,465	1,470	17,585
Juvenile 10.101 ^c	17,742	17,742	17,742	17,742	17,742	17,743	212,905
TDA TOTAL	790,404	790,404	790,404	790,404	790,404	790,453	9,484,897

^a Payment is made on a per credit basis for cases open during the month.

^b This total amount is estimated in consideration of cases open at the beginning of the contract. The actual annual amount may be greater or lesser depending upon new case assignments and the timing of case closing for existing cases.

^c Public Defense Improvement Fund from the Washington State Office of Public Defense.

ATTACHMENT E

NOTIFICATION OF WITHDRAWAL

PLEASE PRINT OR TYPE

Date: _____
 Client Name: _____ AKA: _____
 Address: _____ Phone: _____
 DOB: _____ JCN: _____ CCN: _____
 Cause Number: _____ Charge: _____

Case Type: Felony Seattle Municipal Juvenile
 Dependency Civil Contempt KC Misdemeanor
 ITA Other _____

REASON FOR WITHDRAWAL:

Conflict of Interest Other _____
 Defendant Retained Private Counsel: (Name of Attorney) _____

CONFLICT INFORMATION:

This Agency's conflict is with: Name _____ DOB: _____
 Cause Number: _____ Co-Defendant in Current Case? Yes No
 Victim/Client Suspect/Client Witness/Client Other _____

OTHER NAMES IN DISCOVERY:

NAMES	DOB	STATUS IN CASE	REPRESENTATION HISTORY

SEE ATTACHED SHEET FOR ADDITIONAL LISTINGS

In-Custody Out-of-Custody Received Conflict From: _____

HEARING SCHEDULE:

Trial Date: _____ Next Hearing: _____ Type of Hearing: _____

*Withdrawal Hearing Date: _____
 *(MUST BE TWO FULL WORKING DAYS FROM IDENTIFICATION OF CONFLICT IF TRIAL DATE HAS BEEN SET. AGENCY MUST NOTIFY PA AND CO-DEFENDANT COUNSEL.)

LOCATION OF DISCOVERY:

PA's Office Agency will forward to new counsel Other _____

Request for credit/debit: _____

This form filled out by: _____ Date: _____

APPROVED BY: _____ Date: _____

OPD USE ONLY

OPD REASSIGNED TO: _____ INITIALS: _____ DATE: _____

FAX Interoffice Mail

ATTACHMENT F

[Agency] Persistent Offender (593) Monthly Case Report

Client Name: _____
 Cause No.: _____
 Month/Year: _____
 Attorney(s): _____

Week (Dates)	Attorney (1)	Attorney (2) (if assigned)	Total Atty.	Invest	Social Wkr.	Paralegal	Total Support	Total Week	Total to Date
/ to /									
/ to /									
/ to /									
/ to /									
/ to /									
TOTAL									

NOTE: 12.1 hours = 1.00 credit

Abbreviations must be used to categorize attorney hours:

- CC = Contact with Client
- R = Legal Research
- Ptr = Pretrial Hearing
- Tr = Trial
- S = Sentencing/Disposition
- CP = Case Prep
- C = Confer with attorney/investigator/social worker/paralegal
- N/A = No second attorney assigned

ATTACHMENT G

Racial Disparity Project

The Agency Racial Disparity Project (RDP) will use the \$45,000 King County Office of the Public Defender (OPD) grant to:

1. Challenge the racial composition of King County jury venires in a felony appeal, if Washington (WA) State OPD does not appoint RDP lawyers and if the defendant does not retain private counsel. If WA State OPD appoints the Agency RDP on the lead Campbell case, grant funds shall be used to train and provide technical assistance to trial lawyers on raising the issue in other cases. All attorney and expert costs for cases on appeal are reimbursable to the Agency by WA State OPD if the Agency is appointed; and
2. Coordinate the ongoing selective enforcement challenge to Seattle drug arrests in King County Superior Court and, where necessary, on appeal (attorney costs only, not expert costs). All attorney and expert costs for cases on appeal are reimbursable to the Agency by WA State OPD if the Agency is appointed on appeal; and
3. Work with the King County Executive and with Council staff to explore expansion of the Clean Dreams pre-arrest diversion model for low-level drug offenders to a site in unincorporated King County, and develop a plan in collaboration with County staff for funding the expanded program; and
4. Solicit interest, schedule, advertise, and provide specific CLE eligible training to King County public defense attorneys for at least one-half to one full day. Training announcement shall include King County as training underwriter. Training shall occur by the close of the third quarter of the Contract period.

Timeline:

First Quarter – File Notice of Appeal in jury venire challenge and request appointment by WA State OPD, order transcript and begin briefing. Attempt to complete discovery in selective enforcement challenge. Visit possible sites for expansion of Clean Dreams and begin development of community coalition in support of plan. Help develop evaluation model for existing Clean Dreams project. The Agency shall provide a written report, due to OPD within one month of the close of this quarter, which discusses the progress toward these goals.

Second Quarter – Complete opening brief in jury venire challenge. If WA State OPD appoints RDP attorneys on lead case on appeal, develop training for King County defenders on raising issue in pending trial cases. Prepare and file opening brief in selective enforcement challenge. Work with Executive staff on inclusion of Clean Dreams expansion in 2009 budget. The Agency shall provide a written report, due to OPD within one month of the close of this quarter, which discusses the progress toward these goals.

Third Quarter – Complete reply brief in jury venire challenge and argue appeal; if WA State OPD appointed RDP attorneys on lead case on appeal, conduct training for King County defenders. Continue investigation in selective enforcement case; if State has filed response, prepare reply brief. Work with Council staff on Clean Dreams expansion plan. Provide specific CLE eligible training to King County public defense attorneys for at least one-half to one full day. The Agency shall provide a written report, due to OPD within one month of the close of this quarter, which discusses the progress toward these goals, and the agenda and attendance list from the CLE training.

Fourth Quarter – Conduct evidentiary hearing in selective enforcement challenge. Provide technical assistance in establishment of new Clean Dreams program to begin January 1, 2009. The Agency shall provide a written report, due to OPD within one month of the close of this quarter, which discusses the progress toward these goals.