



## USE AGREEMENT

between

**King County Department of Natural Resources and Parks, Parks and Recreation Division**

and

**Sammamish Rowing Association**

for the

**Rowing Facility**

at

**Marymoor Park**

---

This Agreement (“Agreement”) is entered into by and between King County, by and through the Parks and Recreation Division of the Department of Natural Resources and Parks (“King County”) and Sammamish Rowing Association (“SRA”) (together, the “Parties”) for the design, construction, use, development, programming, repair, and maintenance of a boathouse and related improvements (“Rowing Facility”) at Marymoor Park (“Site”).

In consideration of the promises, covenants, and other provisions set forth in this Agreement, the Parties agree as follows.

### **1. BACKGROUND**

- 1.1. King County, a home rule charter county and political subdivision of the State of Washington, is the owner of the Site, located at 6046 West Lake Sammamish Parkway NE Redmond WA 98052, and described and depicted with greater particularity in Exhibit A to this Agreement.
- 1.2. SRA is a not-for-profit Washington corporation that is tax-exempt under section 501(c)(3) of the Internal Revenue Code. SRA is a community-based, open-membership club organized to provide public recreational and competitive rowing for adults and teens on the eastside.
- 1.3. The existing boathouse on the Site is insufficient to meet present and anticipated regional demand for rowing facilities.
- 1.4. SRA has the experience, ability, and resources to develop a replacement Rowing Facility and intends to develop a Rowing Facility at the Site.
- 1.5. King County has determined that a replacement Rowing Facility located at the Site will have significant and unique regional and/or rural public recreation value.

- 1.6. King County Ordinance 14509 authorized the Department of Natural Resources and Parks to create new public recreation opportunities by empowering user groups, sports associations, and community organizations to operate, maintain, and program mutually agreed-upon capital improvements for public recreation facilities on King County land, and thereby address regional and/or rural recreation needs without incurring new tax funded operations and maintenance costs.
- 1.7. Allowing SRA to develop certain mutually agreed upon capital improvements, including a Rowing Facility at the Site, as well as providing certain mutually agreed-upon maintenance and programming will serve to implement the authority provided in Ordinance 14509, and to achieve the goals set forth in *Section 1.5* above.
- 1.8. King County Code 4.56.150(E) authorizes the Department of Natural Resources and Parks to enter into agreements for the use of King County land by non-profit organizations that provide a service to the public or make improvements to the land.
- 1.9. King County is willing to allow SRA to use, operate, program, maintain and repair the Rowing Facility at the Site under the terms and conditions set forth in this Agreement.

## 2. CONSIDERATION

- 2.1. SRA agrees to design and construct a Rowing Facility on the Site consistent with the terms and conditions set forth in this Agreement. The Rowing Facility will include a boathouse building, safety launch carrel, and related utilities and infrastructure all as set forth in *Exhibit A* to this Agreement. The present total estimate cost to construct the Rowing Facility is approximately four million dollars (\$4,000,000), including design, permitting and anticipated donated services and materials.
- 2.2. SRA agrees to assume all responsibility for design, construction, operation, and maintenance of the Rowing Facility during the term of this Agreement.
- 2.3. In light of SRA's substantial investment in the Rowing Facility, as well as SRA's assumption of all responsibility for the Rowing Facility as set forth in this Agreement, the term of this Agreement ("the Term") is thirty (30) years, subject to earlier termination under *Section 3.6* or *Section 5.23* of this Agreement.
- 2.4. SRA has inspected and knows the condition of the Site, and agrees to accept the Site in as is condition.
- 2.5. King County does not make and specifically disclaims any warranties, express or implied, including any warranty of merchantability or fitness for a particular purpose, with respect to the Site, and no official, employee, representative or agent of King County is authorized to represent otherwise.
- 2.6. King County will provide a total of \$410,000 towards the capital cost to construct Phase 1 of the Rowing Facility at the Site to be dispersed as follows:

Milestone Triggering Payment	Capital Fund Disbursal	Funds To Be Used For	Anticipated Milestone
Receipt of all required permits	\$350,000	Clearing, grading, earth work, foundation, trenching, lay utilities, widen road	May, 2010
Phase 1 Construction Complete	\$60,000	Final construction payments	August, 2010

SRA will be solely responsible to secure and provide all other funding needed to design and construct the Rowing Facility. King County will be under no obligation directly or indirectly to pay for any labor, material, or improvement associated with the Site or the Rowing Facility in excess of the \$410,000 dollar capital grant outlined above. SRA will, upon request, inform any inquiring person or entity that King County has no further financial obligations associated with the construction of the Site or the Rowing Facility.

- 2.7. SRA will pay King County a guaranteed use fee of six thousand dollars (\$6,000) per year for 10 years starting two (2) years from the date of the Rowing Facility's completion (years 2-12).
- 2.8. At least twelve (12) months before the expiration of SRA's obligations under **Section 2.7**, King County and SRA will begin negotiations to set SRA's annual use fee for the next ten-year period under this Agreement. Thereafter, SRA's annual use fee shall be adjusted, consistent with this paragraph, at least every ten years for as long as the Agreement remains in effect. SRA's annual use fees set under this paragraph shall be the greater of: \$6,000 or an amount that will at least cover King County's annual maintenance costs related to the boathouse (e.g., parking lot maintenance).
- 2.9. At least twelve (12) months prior to the expiration of this Agreement, and provided that SRA is then in compliance with the terms and conditions of this Agreement, SRA will notify King County in writing whether SRA desires to negotiate renewal or extension of the Agreement, including any proposed modifications. The County will decide, in its sole discretion and, if necessary, subject to approval by the Metropolitan King County Council ("the Council"), whether to renew or extend this Agreement.
- 2.10. The Parties may modify or amend this Agreement during the Term, or as a condition of any subsequent renewal, extension, or during a renewal or extension term. The Parties acknowledge that modifications or amendments of material terms will require Council approval.
- 2.11. Until the Rowing Facility is substantially complete, SRA may sell naming and advertising rights at the Site and Rowing Facility in order to raise funds for the Rowing Facility, and may keep and retain all revenue from any naming and advertising agreements executed by SRA. Upon substantial completion of the Rowing Facility, all naming and advertising rights related to the Site and Rowing Facility, and not previously sold by SRA, will revert to King County; and King County may thereafter keep and retain all revenue any subsequent naming or advertising agreements related to the Site or the Rowing Facility.

King County and SRA agree to consult with each other in seeking and obtaining naming rights and advertising agreements. For purposes of this Agreement, "substantially complete" and "substantial completion" mean that:

- 2.11.1 SRA or the County has full and unrestricted use and benefit of the Rowing Facility for the purpose intended;
  - 2.11.2 All the systems and parts of the Rowing Facility are functional;
  - 2.11.3 Utilities are connected and operate normally;
  - 2.11.4 Only minor incidental work or correction or repair remains to complete all Rowing Facility-related contract requirements; and
  - 2.11.5 At the County's option, the construction contractor has provided all occupancy permits and easement releases.
- 2.12. SRA may use the Site and the Rowing Facility to conduct tax-exempt fundraising activities to support the Site, the Rowing Facility, or SRA's own beneficial or charitable mission as a not-for-profit Washington corporation; provided, that SRA may not use the Site or the Facility for fundraising activities at times previously reserved for scheduled or unscheduled public use of the Rowing Facility.
- 2.13. King County will retain ownership of the Site and the Rowing Facility, including all improvements, permanent fixtures and County-purchased equipment.
- 2.14. In recognition that the design, development and construction of the Rowing Facility and Site will benefit King County and its citizens upon completion, the Parks and Recreation Division agrees to coordinate with SRA and to use its best efforts to assist with and facilitate the issuance of any federal, state, county or local permits or approvals necessary for construction.
- 2.15. SRA shall abide by and enforce all terms, conditions, reservations, restrictions and covenants of title at the time of conveyance and/or in the deed of conveyance. "SRA acknowledges that the Site was purchased for open space purposes with Conservation Futures funds as authorized by King County Ordinances 10750 and 13717 and covenants that it shall abide by and enforce all terms, conditions and restrictions in Ordinances 10750 and 13717, including that SRA covenants that the Site will continue to be used for the purposes contemplated by these Ordinances, which prohibit both active recreation and motorized recreation but allow passive recreation, and in strict conformance with the uses authorized under RCW 84.34.230, that the Site shall not be transferred or conveyed except by agreement providing that the Site shall continue to be used for the purposes contemplated by these Ordinances and in strict conformance with the uses authorized under RCW 84.343.230, and that the Site shall not be converted to a different use unless other equivalent lands and facilities within the County shall be received in exchanged therefore."

"SRA covenants that it shall not use the Site in a manner that would cause the interest on County bonds related to the Site to no longer be exempt from federal income taxation."

### 3. CONSTRUCTION OF ROWING FACILITY

- 3.1. CAPITAL IMPROVEMENTS. SRA will raise and invest \$3 million in expenditures for the development, permitting and construction of the Rowing Facility on the Site, and contribute an estimated \$500,000 in donated professional services, management services, manpower and materials. SRA will serve as the supervisory not-for-profit corporation for development and construction of the Rowing Facility. SRA shall design, develop, and construct facilities, features, and amenities in accordance with all applicable design(s), timelines, restrictions, environmental considerations, permitting determinations, neighborhood impact mitigations, and all other requirements in coordination with project management staff from King County's Parks and Recreation Division and its Facilities Management Division.
- 3.2. EXCLUSIVE POSSESSION DURING CONSTRUCTION. During the design, development and construction phases of the Rowing Facility, the SRA may have exclusive possession and use of those portions of the Site that are designated for development and construction of the Rowing Facility. SRA's right of exclusive possession and use is subject to King County's entry, inspection and audit rights under *Sections 4.11* and *5.11* of this Agreement.
- 3.3. DESIGN. SRA has retained a licensed architect and/or licensed professional engineer, registered in the State of Washington, who has prepared a design for the Site and the Rowing Facility and exterior landscaping, which visually blends with the setting. While King County has already reviewed the conceptual design plans for the Site, the Parks and Recreation Division reserves the right to approve the final design of the Site and the Rowing Facility. PROVIDED, that the Division's right of review and approval under this *Section 3.3* is not a substitute for any review, permit, or other authorization required under local, state or federal law; and provided further, that by exercising its rights under this *Section 3.3*, the Division does not warrant or guarantee the Site, SRA's plans, or the Rowing Facility for any purpose.
- 3.4. BUILDING AND SITE PLANS. SRA has retained a licensed architect and/or licensed professional engineer, registered in the State of Washington, who has prepared building and site plans for the Site and the Rowing Facility, which reference structures, utilities generally, and landscape plans. The Parks and Recreation Division reserves the right to approve the final building and site plans. PROVIDED, that the Division's right of review and approval under this *Section 3.4* is not a substitute for any review, permit, or other authorization required under local, state or federal law; and provided further, that by exercising its rights under this *Section 3.4*, the Division does not warrant or guarantee the Site, SRA's plans, or the Rowing Facility for any purpose.
- 3.5. CONSTRUCTION/SITE WORK/FENCING. SRA will be solely responsible for the Site work, required permits, and any clearing or grading required to construct the Rowing Facility. SRA will ensure the work area is properly barricaded, and will ensure that signage is installed, directing unauthorized persons not to enter onto the construction site during any phase of development or construction. Unless otherwise agreed by the Parties

in writing, fencing will be placed around work areas. In addition, construction sites will be kept clean and organized during development periods. SRA will be responsible for site security, traffic and pedestrian warnings at the Rowing Facility during the development and construction phases.

- 3.6. CONSTRUCTION DEADLINES. Within four (4) years from the date that SRA receives or has received all funding from King County and all permits or other authorizations necessary to commence construction on the Rowing Facility, the Rowing Facility must be substantially complete as defined in *Section 2.11*. If the Rowing Facility is not substantially complete at the end of that four-year period, then this Agreement will automatically terminate and neither SRA nor King County will have any further duty to perform under or abide by this Agreement.
- 3.7. RELOCATION OF UTILITY LINES. SRA will be responsible to install or relocate storm drains, sewers, water lines, and other utilities, if any, as required to complete development and construction of the Rowing Facility.
- 3.8. ALTERATION OF SITE OR ROWING FACILITY AFTER CONSTRUCTION. After the Rowing Facility is substantially complete as defined in *Section 2.11* of this Agreement, SRA may not make any material alteration to the Site or to the Rowing Facility, including any changes to the landscaping.
- 3.9. DEVELOPMENT AND CONSTRUCTION FEES AND EXPENSES. SRA will be responsible to obtain and pay for all necessary permits, licenses, authorizations, fees and expenses associated with the design, development, and construction of the Rowing Facility.
- 3.10. PUBLIC WORKS LAWS. To the extent applicable, SRA will comply with all public works laws, regulations, and ordinances, including but not limited to those related to prevailing wages (see RCW 39.12), retainage (see RCW 60.28), bonding (see RCW 39.08), use of licensed contractors (see RCW 39.06), and competitive bidding (see RCW 36.32 and RCW 35.21.278). SRA will indemnify and defend King County should it be sued or made the subject of an administrative investigation or hearing for a violation of such laws, regulations, and ordinances in connection with the improvements.
- 3.11. CONTRACTOR INDEMNIFICATION AND HOLD HARMLESS. SRA will require its construction contractors and subcontractors to defend, indemnify and hold King County, its officers, officials, employees and volunteers harmless from any and all claims, injuries, damages, losses or suits including attorney's fees and costs, arising out of or in connection with the design, development and construction of the Rowing Facility (hereinafter "Design and Construction Phase"), except for injuries and damages caused by the negligence of King County.
- 3.12. COMMERCIAL GENERAL LIABILITY INSURANCE. SRA will require its construction contractors to procure and maintain, for the duration of construction of the Rowing Facility, insurance against claims for injuries to persons or damage to property,

which may arise from or in connection with the performance of the work hereunder by the construction contractors and subcontractors, their agents, representatives, or employees. All said policies will name King County as an additional named insured and will include a provision prohibiting cancellation or reduction in the amount of said policies except upon 30 days prior written notice to King County. SRA will require its construction contractors to maintain minimum commercial general liability insurance limits of no less than \$1,000,000 each occurrence; \$2,000,000 general aggregate and a \$2,000,000 products-completed operations aggregate limit; business automobile coverage for a limit of not less than \$1,000,000 combined single limit per occurrence; and workers' compensation coverage as required by the Industrial Insurance Act of the State of Washington, statutory limit.

- 3.13. BUILDERS RISK INSURANCE. SRA will require its construction contractors to procure and maintain, for the duration of the Design and Construction Phase of the Rowing Facility, Builder Risk insurance covering interests of King County and the construction contractor in the work. Builders Risk insurance will be on an all-risk policy form and will insure against the perils of fire and extended coverage and physical loss or damage including flood and earthquake, theft, vandalism, malicious mischief, collapse, temporary buildings and debris removal. This Builders Risk insurance covering the work will have a deductible of \$5,000 for each occurrence, which will be the responsibility of the construction contractor. Higher deductibles for flood and earthquake perils may be accepted by King County upon written request by SRA and written acceptance by King County. Any increased deductibles accepted by King County will remain the responsibility of the construction contractor. The Builders Risk insurance will be maintained until final acceptance of the work by SRA. SRA will require its construction contractors to maintain Builders Risk insurance in the amount of the completed value of the Rowing Facility with no coinsurance provisions.
- 3.14. SUBCONTRACTORS. SRA will require its construction contractors during the Design and Construction Phase to include all subcontractors as insured under its policies or will furnish separate certificates and endorsements for each subcontractor. All coverages for subcontractors will be subject to all of the same insurance requirements as stated herein for the construction contractor.
- 3.15. VERIFICATION OF COVERAGE. SRA will furnish King County with original certificates and a copy of the amendatory endorsements, including but not necessarily limited to the additional insured endorsement, evidencing the Commercial General Liability insurance of the construction contractor before commencement of the work. Before any exposure to loss may occur, SRA will file with King County a copy of the Builders Risk insurance policy that includes all applicable conditions, exclusions, definitions, terms and endorsements related to work under this Agreement.
- 3.16. ACCEPTABILITY OF INSURERS. Unless otherwise approved by King County, the following provisions apply exclusively during the Design and Construction Phase:

- 3.16.1. Insurance is to be placed with insurers with a Best's rating of no less than A:VIII, or, if not rated by Best's, with a rating in one of the two highest categories maintained by Standard & Poor's Rating Group and Moody's Investor Service.
- 3.16.2. If at any time any of the foregoing policies fail to meet the above minimum standards, then SRA will, upon notice to that effect from King County, promptly obtain a new policy, and submit the same to King County with certificates and endorsements, for approvals.
- 3.17. **WAIVER OF SUBROGATION.** SRA will cause its contractors and subcontractors and their insurance carriers to release and waive all rights of subrogation against King County during the Design and Construction Phase to the extent a loss is covered by property insurance in force. Except as otherwise provided in this Article 3 of this Agreement, SRA hereby releases from liability and waives all right of recovery against King County for any loss from perils insured against or under the respective fire insurance policies of its contractors, subcontractors, or any of them, including any extended coverage endorsements thereto; provided, that this provision shall be inapplicable if it would have the effect of invalidating any insurance coverage of SRA or King County.
- 3.18. **INSURANCE PROVISIONS ARE MATERIAL TERMS.** Failure by SRA, its agents, employees, officers, and/or subcontractors to comply with these insurance requirements shall constitute a material breach of this Agreement.
- 3.19. By requiring such minimum insurance as specified herein, neither party is deemed to, or construed to, have assessed the risks that may be applicable to the other party to this Agreement. SRA will assess its own risks and, if it deems appropriate or prudent, or both, maintain greater limits or broader coverage.

#### **4. USE, MAINTENANCE, AND OPERATION OF ROWING FACILITY**

- 4.1. **EXCLUSIVE LICENSE.** In recognition that SRA shall invest substantial funds to design, develop, construct, and provide supplemental maintenance for the Rowing Facility at the Site, King County grants SRA an exclusive license to use the Rowing Facility for providing public rowing programs, subject to the terms and conditions in this Agreement. The term of SRA's license is coextensive with the Term of this Agreement, and will expire or terminate upon the expiration or earlier termination of this Agreement.
- 4.2. **STEWARDSHIP.** SRA agrees to be a good steward of the Rowing Facility and Site. SRA agrees that all of its activities and use of the Site and the Rowing Facility will, to the greatest extent possible, be considerate of the capital, programmatic, and environmental value of the Rowing Facility and Site. SRA further agrees to strictly adhere to all applicable environmental laws and regulations at all times.
- 4.3. **FACILITY USE POLICY.** King County and SRA will mutually develop and implement a Good Neighbor/Rowing Facility Use Policy (Exhibit B) (hereinafter "Use Policy") to



- ensure positive relations with the surrounding community, as well as other current or future Site users. SRA will post Use Policy in clear view at the Rowing Facility and/or integrate the policy into posted or otherwise distributed use rules for the Site. SRA will mitigate for traffic, noise, parking, or other neighborhood impacts; and SRA agrees that its mitigation efforts will be thorough, ongoing, and in good faith.
- 4.4. FACILITY REVENUE AND BUDGET. Revenue associated with any on-site advertising, or naming rights will be managed according to the terms set forth in the Rowing Facility Revenue Plan (Exhibit E).
  - 4.5. FACILITY PROGRAMMING AND USE BY SRA. SRA agrees to bear all costs associated with Rowing Facility programming. SRA's use of the Facility shall be limited to providing programming, equipment repair, and other activities for approved users as presently specified in the SRA Rowing Handbook, as it may be amended from time to time, during approved hours of operations, which hours are as follows: 4:30 a.m. to 12:00 a.m. (midnight). SRA shall develop, post, and enforce Rowing Facility Use Rules as may be required from time to time in accordance with existing SRA policies and procedures pursuant to its Rowing Handbook, attached hereto as Exhibit B. SRA may update, revise, or replace Exhibit B over time, upon written notice to the County.
  - 4.6. SECURITY AND NUISANCE DURING USE. SRA will take reasonable precautions to secure the Rowing Facility during use by SRA. SRA will use the Site and the Rowing Facility for no unlawful purposes, and will not use or occupy the Site in any manner which would constitute a public nuisance or otherwise violate federal, state or local laws, including but not limited to all applicable noise and traffic regulations.
  - 4.7. SITE MAINTENANCE PLAN. Once the Site and Rowing Facility capital improvements are substantially complete as defined in *Section 2.11* of this Agreement, a Rowing Facility Site Maintenance Plan ("SMP") shall be developed and agreed to by the County (through the Park and Recreation Division's maintenance manager, CPG project manager, and management), and reviewed by the Labor Management Committee ("LMC"). The SMP shall be developed in a manner as to ensure King County does not incur any new aggregate operations and maintenance costs requiring additional public funds, except as may be otherwise provided in this Agreement.
  - 4.8. PERFORMANCE REPORT. At the end of each Agreement year, SRA shall furnish the CPG Project Manager with a summary of the prior year's use by SRA for approved activities, maintenance, and the condition of the Rowing Facility.
  - 4.9. LIMITED USE. SRA shall use the Rowing Facility for no other business or purpose than as explicitly provided in this Agreement or as otherwise generally permitted to members of the public. All other uses will require the prior written approval of King County, which shall not be unreasonably withheld.
  - 4.10. SIGNS. No sign, advertisement, notice, or other lettering will be exhibited, inscribed, painted, or affixed by SRA nor allowed by SRA to be exhibited, inscribed painted, or

affixed on any part of the Rowing Facility without the prior written approval of King County, which shall not be unreasonably withheld. All new Rowing Facility and/or Site signs shall follow the King County Sign System Guide and shall be manufactured and installed by King County, unless SRA receives prior written approval of King County to do otherwise. Written approval shall be requested through King County's liaison. If SRA violates this provision, King County may remove the sign without any liability and may charge the expense incurred by such removal to the SRA. All signs erected or installed pursuant to King County's prior written approval shall also comply with any applicable federal, state or local statutes, ordinances or regulations.

- 4.11. **RIGHT TO INSPECT.** King County at its discretion reserves the right to review and approve SRA's use of the Rowing Facility and compliance with this Agreement. If King County does not approve of SRA's use and compliance, King County will timely notify SRA in writing of the specific items that King County deems objectionable. SRA agrees to undertake reasonable corrective action within a time period agreed to by the Parties, or if no time period is agreed, within sixty (60) days.
- 4.12. **MINIMUM SCOPE OF INSURANCE FOR SRA.** In addition to the Design and Construction Phase insurance requirements set forth in Article 3, SRA will, at a minimum, maintain insurance to cover SRA's activities and operation, maintenance, use, and repair of the Rowing Facility and the Site. **SRA's insurance must meet all of the requirements set forth in Exhibit C to this Agreement, in this Section 4.12, and in Section 4.13 of this Agreement.** King County reserves the right to update, amend, or replace Exhibit C and the insurance requirements set forth therein, upon written notice to SRA.
- 4.12.1. **ACCEPTABILITY OF INSURERS.** Unless otherwise approved by King County, the following provisions apply exclusively to SRA's activities and usage of the Rowing Facility and Site after the Design and Construction Phase.
- 4.12.2. Insurance is to be placed with insurers with a Best's rating of no less than A:VIII, or, if not rated by Best's, with a rating in one of the two highest categories maintained by Standard & Poor's Rating Group and Moody's Investor Service.
- 4.12.3. If, at any time, SRA's insurance policies fail to meet the minimum standards set forth in Exhibit C or in this **Section 4.12** or in **Section 4.13**, then SRA will, upon notice to that effect from King County, promptly obtain a new policy or policies, and submit the same to King County with certificates and endorsements, for approvals.
- 4.12.4. **WAIVER OF SUBROGATION.** SRA and its insurance carriers will release and waive all rights of subrogation against King County to the extent a loss is covered by property insurance in force. SRA hereby releases from liability and waives all right of recovery against King County for any loss from perils insured against or under their respective fire insurance policies, including any extended

coverage endorsements thereto; provided, that this provision shall be inapplicable if it would have the effect of invalidating any insurance coverage of SRA or King County.

#### 4.13. OTHER INSURANCE MATTERS.

- 4.13.1. Each insurance policy will be written on an "occurrence" form.
- 4.13.2. By requiring such minimum insurance as specified herein, neither party is deemed to, or construed to, have assessed the risks that may be applicable to the other party to this Agreement. SRA will assess its own risks and, if it deems appropriate or prudent, or both, maintain greater limits or broader coverage.
- 4.13.3. SRA will furnish King County with certificates of insurance and endorsements as required by this Agreement. The certificates and endorsements for each policy must be signed by a person authorized by that insurer to bind coverage on its behalf. The certificates and endorsements for SRA's insurance must be on forms approved by King County and must be received and approved by King County prior to the Effective Date of this Agreement as specified in **Section 5.35**. King County reserves the right to require complete certified copies of all required policies at any time.

#### 4.14. KING COUNTY INSURANCE

- 4.14.1. **LIABILITY EXPOSURE.** SRA acknowledges, agrees, and understands that the County is self-insured for all of its liability exposures. The County agrees, at its own expense, to maintain through its self-insurance program coverage for its liability exposures for the duration of this Agreement, or, in the County's sole discretion, to purchase equivalent insurance coverage through an insurance policy or policies, or through a risk sharing pool. The County agrees to provide SRA with at least thirty (30) days prior written notice of any change in the County's self-insured status, and will, upon request, provide SRA with a letter of self-insurance as adequate proof of insurance.
- 4.14.2. **WORKERS' COMPENSATION.** SRA acknowledges, agrees, and understands that the County is self-insured for all of its workers' compensation liability exposure. The County agrees, at its own expense, to maintain through its self-insurance program coverage for its workers' compensation liability exposure for the duration of this Agreement, or, in the County's sole discretion, to purchase equivalent insurance coverage through an insurance policy or policies, or through a risk sharing pool. The County agrees to provide SRA with at least thirty (30) days prior written notice of any change in the County's self-insured status and will, upon request, provide SRA with a letter of self-insurance as adequate proof of insurance.

## 5. GENERAL TERMS AND CONDITIONS

5.1. NOTICE. Notice will be given as follows:

5.1.1. If to King County:

**T.J. Davis, ADOP Project Manager**  
**King County Department of Natural Resources and Parks**  
**201 South Jackson St, Suite 701**  
**Seattle, WA 98104-3855**  
**Email: tj.davis@kingcounty.gov**  
**Phone: (206) 263-6214**

5.1.2. If to SRA:

**Marcy Chartier, Director**  
**Sammamish Rowing Association**  
**P.O. Box 3309**  
**Redmond, WA 98073**  
**Email: director@srarowing.com**  
**Phone: (425) 653-2583**

5.2. NONDISCRIMINATION. SRA will comply with King County Code Chapter 12.16 regarding nondiscrimination in employment, K.C.C. Chapter 12.17 regarding nondiscrimination in contracting, and K.C.C. Chapter 12.18 regarding fair employment practices.

5.2.1. Employment. SRA does not anticipate hiring any employees to develop, program, and maintain the Rowing Facility or otherwise perform its obligations under this Agreement. If SRA should elect to do so, however, SRA agrees not to discriminate against any employee or applicant for employment because of sex, age, race, color, creed, national origin, sexual orientation, gender identity or expression, marital status or the presence of any sensory, mental, or physical handicap, unless based upon a bonafide occupational qualification. This requirement shall apply without limitation to all aspects of employment (including lay-offs or termination, rates of pay or other forms of compensation, and selection for training, including apprenticeship) and advertisement.

5.2.2. Services and activities. No person shall be denied or subjected to discrimination in receipt of the benefit of any services or activities made possible by or resulting from this Agreement on the grounds of sex, race, color, creed, national origin, sexual orientation, gender identity or expression, age (except minimum age and retirement provisions), marital status, or the presence of any sensory, mental, or physical handicap. Any violation of this provision shall be considered a violation of a material provision of this Agreement and shall be grounds for termination or suspension in whole or in part of this Agreement by King County and may result in ineligibility for further King County agreements.

- 5.2.3. Other nondiscrimination laws. SRA shall also comply with all applicable anti-discrimination laws or requirements of any and all jurisdictions having authority.
- 5.3. ASSIGNMENT. SRA may not assign this Agreement or any interest therein without King County's prior approval, which shall not be unreasonably withheld. King County may sell or otherwise transfer or dispose of the Site or the Rowing Facility, or assign this Agreement or any interest of the County hereunder, provided that in the event of sale or transfer of the Site or the Rowing Facility, King County will arrange for the purchaser or transferee to assume the Agreement and King County's obligations hereunder. King County will not otherwise assign this Agreement or any interest of King County hereunder unless the assignee or purchaser agrees to assume King County's obligations hereunder.
- 5.4. ADVERTISING RESTRICTIONS. SRA understands that the advertising of tobacco products as defined in King County Ordinance No. 10615 and spirits as defined in King County Ordinance No. 14509 is strictly prohibited. SRA further understands that pursuant to Ordinance No. 14509, additional subject-matter restrictions on advertising may be imposed by the Director of the County Parks and Recreation Division ("Director"). If the Director imposes additional restrictions, a copy of the restrictions will be included in an exhibit hereto. Therefore, SRA expressly covenants that neither it nor any of its sponsors or concessionaires will at any time display, promote or advertise any tobacco products, spirits or other subject matter expressly prohibited by the Director. SRA further agrees that any violation of this Section by it will be a material breach of its contractual obligations to King County pursuant to this Agreement.
- 5.5. FOR-PROFIT ACTIVITIES. Except as otherwise provided in this Agreement, all commercial activities, for-profit business transactions, soliciting, peddling, or the posting of signs on or at the Site, the Rowing Facility, or in adjacent areas, are each prohibited without the prior written approval from King County.
- 5.6. POWERS OF THE COUNTY. Nothing contained in this Agreement will be considered to diminish the governmental or police powers of King County.
- 5.7. FORCE MAJEURE. The performance of this Agreement by either party is subject to acts of God, war, government regulation or advisory, disasters, fire, accidents or other casualty, strikes or threat of strikes, civil disorder, acts and/or threats of terrorism, or curtailment of transportation services or facilities, cost or availability of power, or similar causes beyond the control of either party making it illegal, impossible or impracticable to hold, reschedule or relocate the Rowing Facility or subsequent use of the Rowing Facility. Either party may terminate or suspend its obligations under this Agreement if such obligations are prevented by any of the above events to the extent such events are beyond the reasonable control of the party whose reasonable performance is prevented.
- 5.8. AGREEMENT IS PUBLIC DOCUMENT. This Agreement will be considered a public document and will be available for inspection and copying by the public.

- 5.9. TAXES. SRA agrees to pay on a current basis all applicable taxes or assessments levied on its activities; PROVIDED, however, that nothing contained herein will modify SRA's right to contest any such tax, and SRA will not be deemed to be in default as long as it will, in good faith, be contesting the validity or amount of any such taxes.
- 5.10. NO SRA LIENS.
- 5.10.1 SRA acknowledges and agrees that it has no authority, express or implied, to create or place any lien or encumbrance of any kind or nature whatsoever upon, or in any manner to bind, the interest of King County in the fee interest in the Site or in the Rowing Facility, or to charge fees for any claim in favor of any person or entity dealing with SRA, including those who may furnish materials or perform labor for any construction or repairs. If any such liens are filed, King County may, without waiving its rights and remedies for breach, and without releasing SRA from its obligations under this Agreement, require SRA to post security in form and amount reasonably satisfactory to King County or to cause such liens to be released by any means King County deems proper, including payment upon satisfaction of the claim giving rise to the lien. SRA will pay to King County upon demand any sum paid by King County to remove the liens. Further, SRA agrees that it will save and hold King County harmless from any and all loss, cost, or expenses based on or arising out of the asserted claims or liens, except those of the lender, against this Agreement or against the right, title and interest of King County in the Site and the Rowing Facility or under the terms of this Agreement, including reasonable attorney's fees and costs incurred by King County to remove such liens, and in enforcing this paragraph. Additionally, it is mutually understood and agreed that this paragraph is intended to be a continuing provision applicable to future repairs and improvements after the initial development and construction of the Site and the Rowing Facility.
- 5.10.2 Nothing herein shall imply any duty upon King County to do any work required to be performed by SRA in this Agreement, and the performance thereof by King County will not constitute a waiver of SRA's default. King County will not in any event be liable for any inconvenience, annoyance, or disturbance that SRA may experience in connection with its activities on the Site or at the Rowing Facility; provided, that King County Parks and Recreation Division will not affirmatively act in a manner that would reasonably be expected to result in a loss of business or other damage to SRA; provided further, that nothing in this *Section 5.10.2* will prevent the County from enforcing the terms of this Agreement or any legally-mandated permit, license, authorization, or any applicable statute, ordinance, or regulation.
- 5.10.3 Except as expressly provided hereunder, all obligations of SRA under this Agreement will be performed by SRA at SRA's sole cost and expense. If SRA fails to pay any sum of money owed to any party other than King County for which SRA is liable hereunder, or if SRA fails to perform any other act on its part to be performed hereunder, and such failure continues for ten (10) days after

notice thereof by King County, King County may, without waiving or releasing SRA from its obligations, make any such payment or perform any such other act to be made or performed by SRA. SRA will pay King County, on demand, all sums so paid by King County and all necessary incidental costs, together with interest thereon at the lesser of one percent (1%) per month or the maximum rate permissible by law, from the date of such payment by King County.

- 5.11. RECORDS, AUDITS AND INSPECTIONS. During the Term of this Agreement, SRA's books, records and other materials related to any matters covered by this Agreement and not otherwise privileged shall be subject to inspection, review, and/or audit by King County upon request and at King County's sole expense. Such books, records and other materials shall be made available for inspection during regular business hours within a reasonable time of the request.
- 5.12. ENTRY BY KING COUNTY. During the Term, King County may enter the Site or the Rowing Facility at any time and for any reason. Any person or persons who may have an interest in the purposes of King County's visit may accompany King County. King County has the right to use any and all means that King County deems proper to open doors and gates to obtain entry to the Site or to the Rowing Facility.
- 5.13. COMPLIANCE WITH ALL LAWS AND REGULATIONS. In using the Rowing Facility, SRA and its members shall comply with all applicable laws, ordinances and regulations from any and all authorities having jurisdiction and, specifically, the requirements of the Washington Industrial Safety and Health Act (WISHA). SRA specifically agrees to comply and pay all costs associated with achieving such compliance without notice from King County, and further agrees that King County does not waive this provision by giving notice of demand for compliance in any instance.
- 5.14. INTERPRETATION OF COUNTY CODE AND RULES. If there is any question regarding the interpretation of any provision of King County Code or any King County rule or regulation, King County's decision will govern and will be binding upon SRA.
- 5.15. PERMITS AND LICENSES. SRA will obtain and maintain, at its own costs and expense, all necessary permits, licenses and approvals required for the activities and improvements contemplated under this Agreement.
- 5.16. RISK OF LOSS. All personal property of any kind or description whatsoever on the Site or the Rowing Facility shall be at SRA's sole risk, and King County will not be liable for any damage done to, or loss of, such personal property. However, SRA will not be responsible for losses or claims of stolen property during King County-scheduled use of the Site or the Rowing Facility by persons or entities other than SRA.
- 5.17. ENVIRONMENTAL LIABILITY.

- 5.17.1. "Hazardous Materials" as used herein shall mean any hazardous, dangerous or toxic wastes, materials, or substances as defined in state or federal statutes or regulations as currently adopted or hereafter amended.
- 5.17.2. SRA shall not, without first obtaining King County's written approval, apply, store, deposit, transport, release or dispose of any hazardous substances, petroleum products, sewage, medicinal, bacteriological, or toxic materials, or pollutants, on the Site or at the Rowing Facility. All approved application, storage, deposit, transportation, release and disposal shall be done safely and in compliance with applicable laws.
- 5.17.3. Nothing in this Agreement shall be deemed to waive any statutory claim for contribution that SRA might have against King County under federal or state environmental statutes that arises from hazardous materials deposited or released on the Site by King County. SRA may not, however, assert such a claim to the extent that SRA creates the need for or exacerbates the cost of remediation upon which a statutory claim for contribution is based as a result of SRA performing construction activities on the Site, changing the configuration of the Site, or changing the use of the Site.
- 5.17.4. If SRA discovers the presence of hazardous materials at levels that could give rise to a statutory claim for contribution against King County it shall immediately notify King County in writing. Such notice shall in no event be provided more than ten (10) days after discovery. Prior to undertaking any remediation, the Parties shall make their best efforts to agree as to which party is responsible for remediation under the terms of this Agreement.
- 5.17.5. In no event shall King County be responsible for any costs of remediation that exceed the minimum necessary to satisfy the state or federal agency with jurisdiction over the remediation.
- 5.18. **NO EMPLOYMENT RELATIONSHIP.** In providing services under this Agreement, SRA is an independent Contractor, and neither it, nor its officers, agents, employees, or subcontractors are employees of King County for any purpose. SRA shall be responsible for all federal and/or state tax, industrial insurance, and Social Security liability that may result from the performance of and compensation for these services and shall make no claim of career service or civil service rights which may accrue to a County employee under state or local law. King County assumes no responsibility for the payment of any compensation, wages, benefits, or taxes by, or on behalf of SRA, its employees, subcontractors and/or others by reason of this Agreement.
- 5.19. **INDEMNIFICATION AND HOLD HARMLESS.**
- 5.19.1. SRA shall protect, indemnify, and hold harmless King County, its officers, agents, and employees from and against any and all claims, costs, and/or losses whatsoever occurring or resulting from (1) SRA's failure to pay any such



compensation, wages, benefits, or taxes as set forth in Paragraph 5.18 above, and/or (2) work, services, materials, or supplies to SRA employees or other SRA suppliers in connection with or support of the performance of this Agreement.

- 5.19.2. SRA further agrees that it is financially responsible for and will repay King County all indicated amounts following an audit exception which occurs due to the negligence, intentional act, and/or failure for any reason to comply with the terms of this Agreement by SRA, its officers, employees, agents, representatives, or subcontractors. SRA's duty to repay King County will survive the expiration or prior termination of this Agreement.
- 5.19.3. SRA expressly agrees to protect, defend, indemnify and hold harmless King County, its elected and appointed officials, officers, employees, and agents from and against liability for any claims (including all demands, suits, and judgments) for damages arising out of injury to persons or damage to property where such injury or damage is caused by, arises out of, or is incident to SRA's use of the Site or the Rowing Facility under this Agreement. SRA's obligations under this **Section 5.19.3** shall include, but not be limited to:
- 5.19.3.1. The duty to promptly accept tender of defense and provide defense to the King County at SRA's expense for claims that fall within this Section 5.19;
- 5.19.3.2. Indemnification of claims, including those made by SRA's own employees and/or agents for this purpose, for claims that fall within this Section 5.19;
- 5.19.3.3. In the event King County incurs any judgment, award and/or cost arising from claims that fall within this section 5.19, including attorney's fees to successfully enforce the section, all such fees, expenses, and costs shall be recoverable from SRA.
- 5.19.3.4. SRA shall protect, defend, indemnify, and hold harmless King County, its officers, employees and agents from any and all costs, claims, judgments, and/or awards of damages arising out of, or in any way resulting from the performance or non-performance of the obligations under this Agreement by SRA's subcontractor(s), its officers, employees, and/or agents in connection with or in support of this Agreement.
- 5.19.3.5. SRA expressly and specifically agrees that its obligations under this paragraph 5.19.3 extend to any claim, demand, and/or cause of action brought by or on behalf of any of its employees, or agents. For this purpose, SRA, hereby expressly and specifically waives, with respect to King County only, any immunity that would otherwise be

available against such claims under the Industrial Insurance provisions of Title 51 RCW, but only to the extent necessary to indemnify King County.

- 5.19.4 SRA understands, acknowledges, and agrees that its duties under this Section 5.19 will survive the expiration or earlier termination of this Agreement.
- 5.20. **WAIVER OF BREACH.** Waiver of any breach of this Agreement shall not be deemed to be a waiver of any other or subsequent breach, and shall not be construed to be a modification of the terms of the Agreement, unless stated to be such through written approval by King County, which approval shall be attached to the original Agreement.
- 5.21. **AMENDMENTS AND REVISIONS.** The Parties reserve the right to modify this Agreement as necessary to equitably address unforeseen circumstances that may arise. The Parties agree to cooperate in good faith and in the spirit of this Agreement with respect to any such requested modifications. Any such amendments or addendums to this Agreement shall be in writing and executed with equal formality as this Agreement.
- 5.22. **DISPUTE RESOLUTION.** The Parties agree to use their best efforts to resolve disputes regarding this Agreement in an economic and time-efficient manner to advance the purposes of this Agreement. In the event that a dispute arises between SRA and King County, they shall attempt to resolve such dispute as expeditiously as possible and will cooperate so that the express purposes of this Agreement are not frustrated, and so that any design, planning, construction, or use of the Rowing Facility on the Site is not delayed or interrupted. Provided, that nothing in this Agreement shall otherwise limit the Parties' legal, equitable, or other rights or remedies.
- 5.23. **TERMINATION/NOTICE/CURE.** In recognition that SRA shall invest substantial funds to develop, program, and provide supplementary maintenance for the Rowing Facility at the Site and in appreciation that King County has fiduciary responsibilities to its residents and taxpayers that may change over time, the Parties agree that once the Rowing Facility is substantially complete as defined in *Section 2.11*, this Agreement may be terminated as follows:
- 5.23.1. **TERMINATION FOR DEFAULT.**
- 5.23.1.1. **KING COUNTY'S DEFAULT.** King County will not be in default unless King County fails to perform an obligation within sixty (60) days after notice by SRA, which notice must specify the alleged breach; provided that if the nature of King County's breach is such that more than sixty (60) days are reasonably required for cure, then King County will not be in default in King County commences to cure within sixty (60) days of SRA's notice and thereafter diligently pursues completion and completes performance within a reasonable time.

- 5.23.1.2. SRA'S DEFAULT. The occurrence of any one or more of the following events constitutes a default by SRA under this Agreement, and is a sufficient basis for King County to terminate this Agreement:
- (1) SRA fails to perform under any covenants, conditions, or provisions of this Agreement, other than the covenants for the payment of use fees required by this Agreement, where such failure continues for a period of sixty (60) days after written notice is given by King County; provided that if the nature of SRA's breach is such that more than sixty (60) days are reasonably required for cure, then SRA will not be in default if SRA commences to cure within sixty (60) days of King County's notice and thereafter diligently pursues completion and completes performance within a reasonable time; or
  - (2) SRA is adjudged a bankrupt, makes a general assignment for the benefit of creditors, or takes the benefit of any insolvency act, or a permanent receiver and trustee in bankruptcy is appointed for SRA's estate and such appointment is not vacated within sixty (60) days; or
  - (3) if this Agreement is assigned or the Site or the Rowing Facility is used by SRA for activities other than in accordance with the terms of this Agreement, and such default is not cured within thirty (30) days after written notice from King County to SRA; or
  - (4) SRA fails to make any payment when due, or fails to make any other payment required hereunder when due, and that failure is not cured within thirty (30) days after mailing of written notice thereof by King County.
- 5.23.2. TERMINATION FOR CHANGE IN SRA STATUS. King County may terminate this Agreement without penalty or liability if, at any time during the Term of this Agreement, SRA loses or changes its status: (1) as an active Washington not-for-profit corporation; or (2) as a tax-exempt organization under section 501(c)(3) of the Internal Revenue Code as now or hereafter codified; or (3) SRA fails to maintain or timely reinstate the insurance required under *Section 4.12* of this Agreement. Provided, that King County will not terminate the Agreement under this section if SRA seasonably cures any and all such loss or change of status.
- 5.23.3. DEFAULT FOR OTHER CAUSE. This Agreement may be immediately terminated for other cause by a party if the other party substantially fails to perform its obligations under this Agreement, through no fault of the terminating party, and the non-performing party does not commence correction of the failure of performance within sixty (60) days of the terminating party's sending notice to the non-performing party.

- 5.23.4. OTHER SRA TERMINATION. SRA may terminate this Agreement for any reason upon twelve (12) months notice in writing to King County. If SRA terminates the Agreement under this *Section 5.23.5*, the SRA shall not be entitled to any compensation from King County for capital improvements made by SRA to the Site.
- 5.23.5. OTHER KING COUNTY TERMINATION.
- 5.23.5.1. King County may terminate this Agreement without cause upon twelve (12) months notice in writing to SRA. In this event SRA shall be entitled to reasonable compensation from King County for capital improvements made by SRA to the Site with due regard for the funds invested by SRA, SRA debts remaining to be paid relating to the Rowing Facility, the fair market value of the Rowing Facility at the time of termination, and the length of time SRA has had use of the Rowing Facility.
- 5.23.5.2. Any King County obligations under this Agreement beyond the current appropriation year are conditioned upon the Council's appropriation of sufficient funds to support such obligations. If the Council does not approve such appropriation, then this Agreement will terminate automatically at the close of the current appropriation year.
- 5.23.6. REMEDIES ARE CUMULATIVE. Remedies under this Agreement are cumulative; the failure to exercise any right on any occasion will not operate to forfeit such remedy.
- 5.24. DESTRUCTION OF PREMISES AND USE OF INSURANCE PROCEEDS.
- 5.24.1. Unless otherwise mutually agreed by the Parties, if the Site or the Rowing Facility are destroyed or injured by fire, earthquake, or other casualty during the Design and Construction Phase, then SRA will proceed to rebuild and restore the Site and the Rowing Facility, or such part thereof as may be injured or destroyed. In the event of any loss covered by the insurance policies described and required under this Agreement, unless this Agreement is terminated as provided herein, SRA will use the proceeds of such insurance policies first to rebuild and then to restore the Site and the Rowing Facility and replace the improvements, fixtures, and equipment, which may be damaged or destroyed by such casualty.
- 5.24.2. Unless otherwise mutually agreed by the Parties, if the Site or the Rowing Facility are destroyed by fire, earthquake or other casualty after substantial completion of the Rowing Facility as defined in *Section 2.11* of this Agreement, then King County will proceed to rebuild and restore the Site and the Rowing Facility, or such part thereof as may be injured or destroyed. In the event of any

loss covered by the insurance policies described and required under this Agreement, unless this Agreement is terminated as provided herein, King County will use the proceeds of such insurance policies first to rebuild and then to restore the Site and the Rowing Facility and replace the improvements, fixtures, and equipment, which may be damaged or destroyed by such casualty.

- 5.25. DUTIES UPON TERMINATION. Upon termination of this Agreement, and unless otherwise arranged, SRA will remove from the Site and the Rowing Facility all its personal property, goods, and effects. If SRA fails to perform this duty at termination, King County may cause such removal to be made and SRA's personal property, goods and effects to be stored, the cost and expense to be paid by SRA. It is understood and agreed that the real property constituting the Site and the Rowing Facility is the real property of King County and that all improvements to that real property will continue to belong to King County upon termination of this Agreement.
- 5.26. EMINENT DOMAIN. The following rules will govern the rights and duties of the Parties in the event of interference with SRA's design, construction, or use of the Site or the Rowing Facility as a result of the exercise of eminent domain or private purchase in lieu thereof.
- 5.26.1. RIGHT OF TERMINATION. If the whole of the Site or the Rowing Facility is taken for any public or quasi-public use under any statute or by right of eminent domain, or by private purchase in lieu thereof, then this Agreement will automatically terminate as of the date that title is taken. If more than twenty-five percent (25%) of the Site or the Rowing Facility is so taken and if the taking renders the remainder thereof unusable for the purposes contemplated under this Agreement, then SRA and King County will each have the right to terminate this Agreement on thirty (30) days notice to the other, given within ninety (90) days after the date of such taking. Provided, however, that if King County is exercising its right of eminent domain, a fair value will be placed on this Agreement and the Rowing Facility with the compensation thereof awarded solely to SRA.
- 5.26.2. NON-TERMINATION. If any part of the Site or the Rowing Facility is so taken and this Agreement is not terminated, then King County will, at its own cost and expense, restore the remaining portion of the Site and the Rowing Facility to the extent necessary to render it reasonably suitable for the purposes contemplated under this Agreement.
- 5.26.3. COMPENSATION. The compensation awarded or paid upon a total or partial taking of the Site or the Rowing Facility, or this Agreement, or any of them, will belong to and be apportioned between SRA and King County in accordance with their respective interests under this Agreement as determined between them or by a court. Additionally, SRA may prosecute any claim directly against the condemning authority for the costs of removal of the goodwill, stock, trade fixtures, furniture and other personal property belonging to SRA. King County

will have no claim to condemnation proceeds attributable to SRA's interest in the Rowing Facility, nor will SRA have any interest in King County's condemnation proceeds, if any.

- 5.27. SURRENDER. Within thirty (30) days of the time this Agreement expires or is terminated, SRA shall remove any and all of its portable improvements at the Rowing Facility. If improvements include non-portable fixtures, such improvements shall inure to the benefit of King County and shall remain at the Rowing Facility.
- 5.28. HEADINGS NOT PART OF AGREEMENT. The headings and other formatting in this Agreement are for convenience only and shall not be deemed to expand, limit, or otherwise affect the substantive terms of this Agreement.
- 5.29. GOVERNING LAW. This Agreement shall be governed by the laws of the State of Washington, without regarding to its conflicts of law rules or choice of law provisions.
- 5.30. JURISDICTION AND VENUE. The exclusive jurisdiction and venue for any disputes arising under this Agreement, including matters of construction, validity and performance, shall be in the Superior Court for King County in Seattle, Washington; and the Parties agree to submit to the personal jurisdiction of that court.
- 5.31. RIGHT TO PARTICIPATE IN LITIGATION. SRA may participate in any litigation, arbitration or dispute directly affecting the Site, the Rowing Facility or interest of SRA therein, including, without limitation, any suit, action, arbitration proceeding, condemnation proceeding or insurance claim. King County, upon instituting or receiving notice of any such litigation, arbitration or dispute will promptly notify SRA of the same.
- 5.32. EXHIBITS.
- A. Legal Description and Illustration of Site and Rowing Facility
  - B. Use Policy
  - C. CPG Insurance Requirements and documentation of coverage
  - D. Facility Revenue Plan
  - E. State Environmental Policy Act (SEPA) – City of Redmond
- 5.33. ENTIRE AGREEMENT. This Agreement and any and all exhibits expressly incorporated herein by reference and attached hereto shall constitute the whole agreement between King County and SRA. There are no terms, obligations, allowances, covenants, or conditions other than those contained herein.
- 5.34. SEVERABILITY. Should any provision of this Agreement be found to be invalid, illegal or unenforceable by any court of competent jurisdiction, such provision shall be stricken and the remainder of this Agreement shall nonetheless remain in full force and effect unless striking such provision shall materially alter the intention of the Parties.
- 5.35. EFFECTIVE DATE. This Agreement will be effective upon the date that it is fully executed by the Parties.

IN WITNESS WHEREOF, the parties hereto have executed this Agreement as of the last date written below.

King County

Sammamish Rowing Association

\_\_\_\_\_  
Theresa Knakal, President  
Sammamish Rowing Association

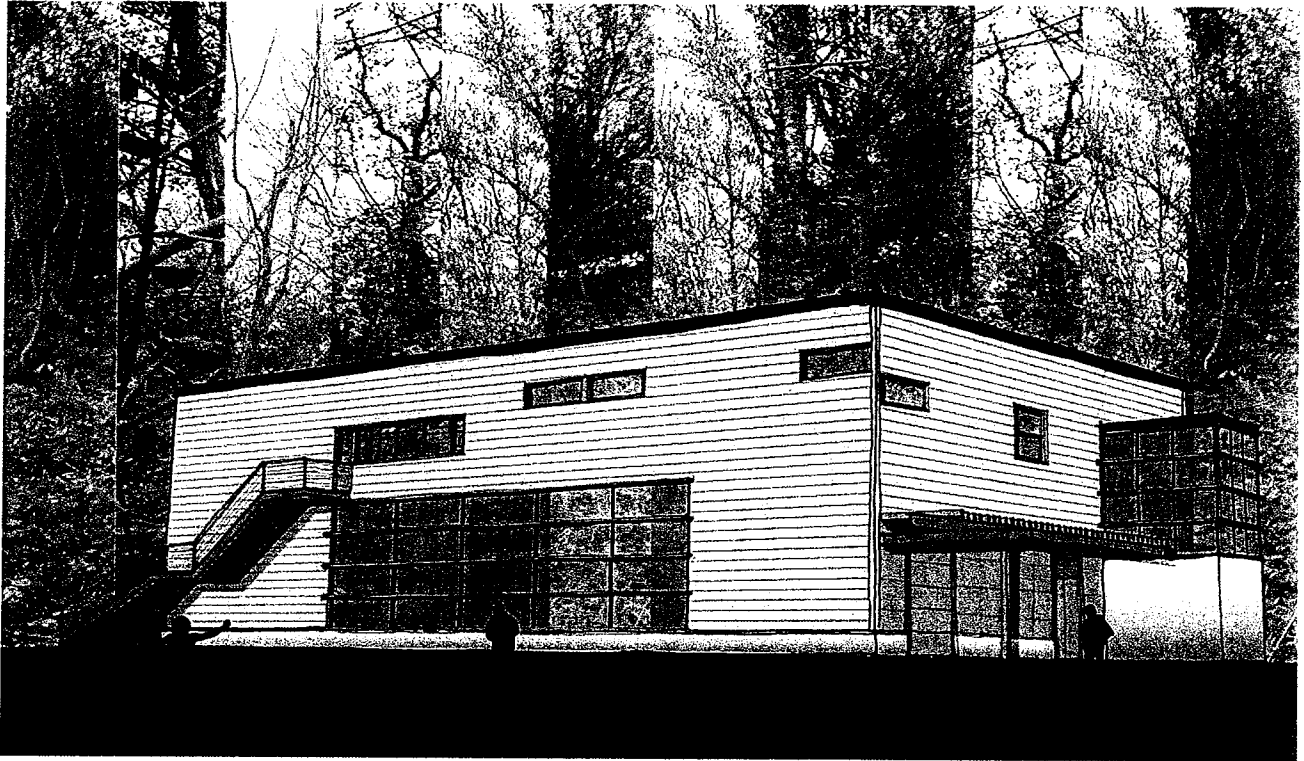
\_\_\_\_\_  
Kevin Brown, Division Director  
King County Parks and Recreation

Date \_\_\_\_\_

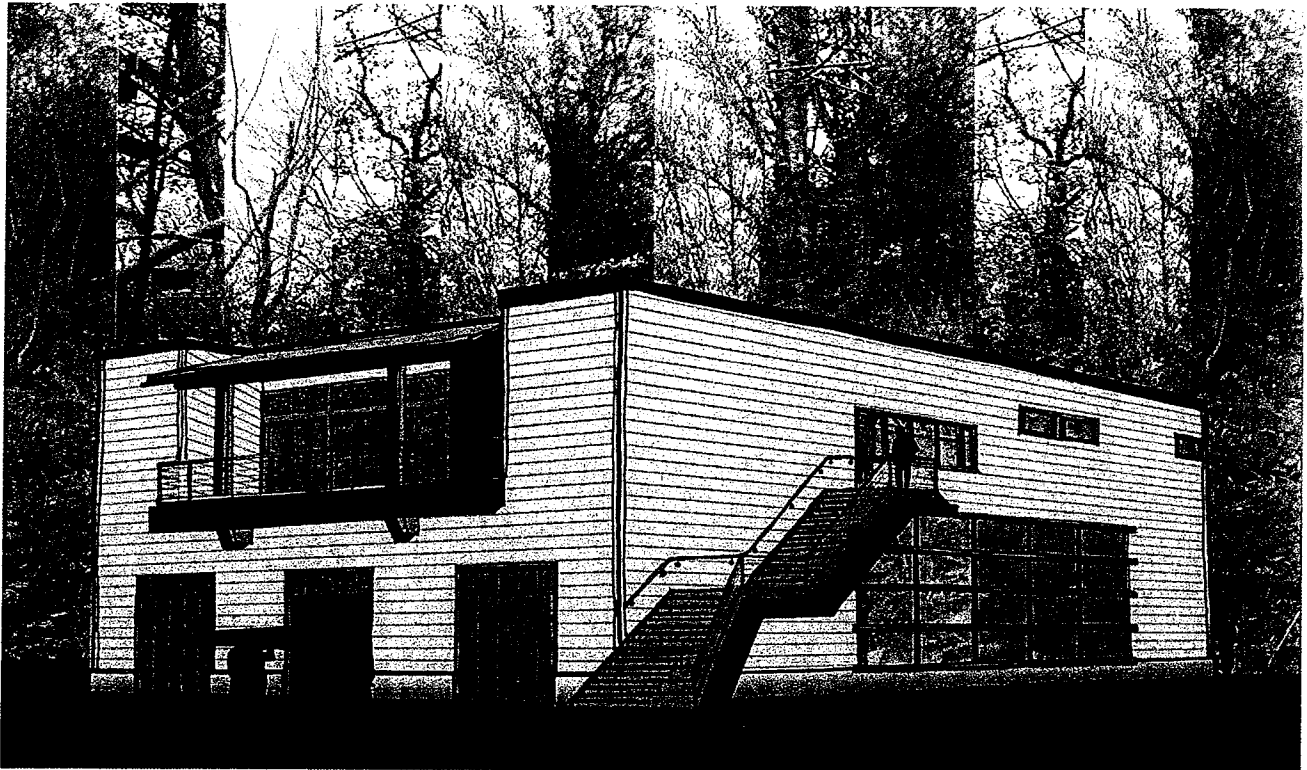
Date \_\_\_\_\_

**Exhibit A: Description and Illustration of Site and Facility:**



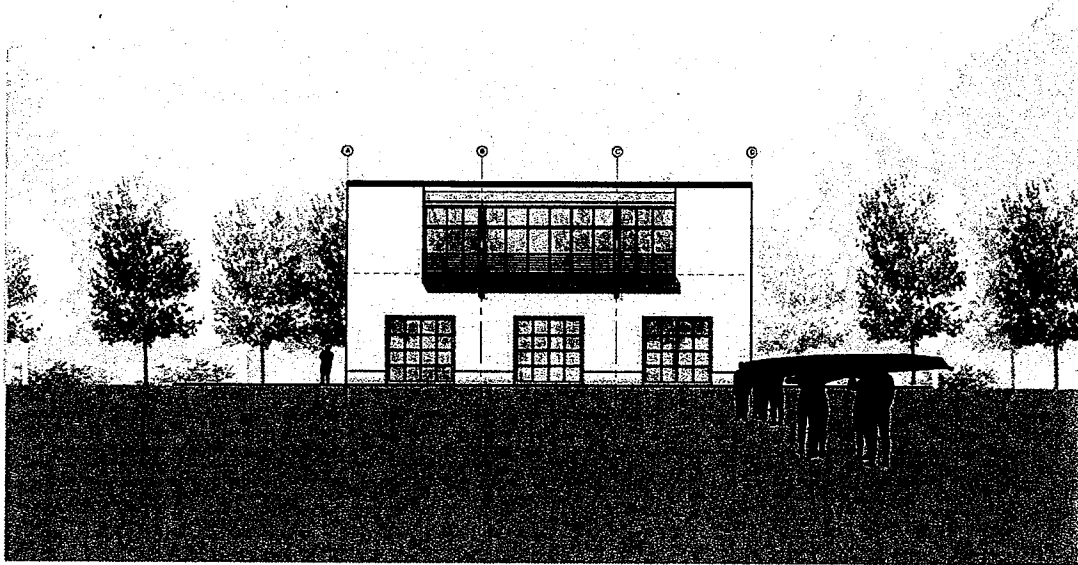


**SAMMAMISH ROWING ASSOCIATION BOATHOUSE**  
SOUTHWEST PERSPECTIVE

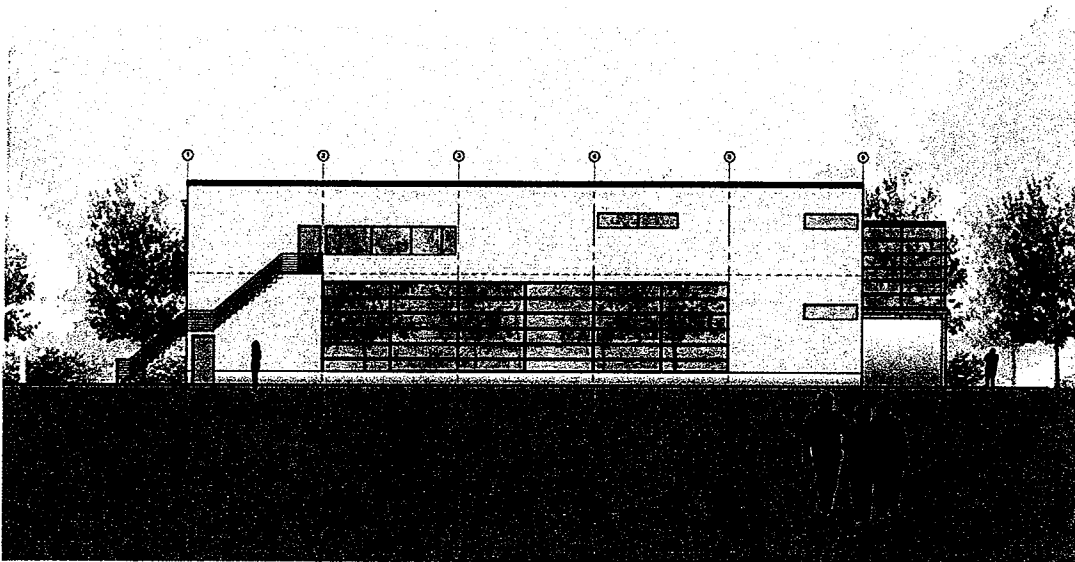


**SAMMAMISH ROWING ASSOCIATION BOATHOUSE**  
NORTHWEST PERSPECTIVE





**SAMMAMISH ROWING ASSOCIATION BOATHOUSE**  
NORTH ELEVATION



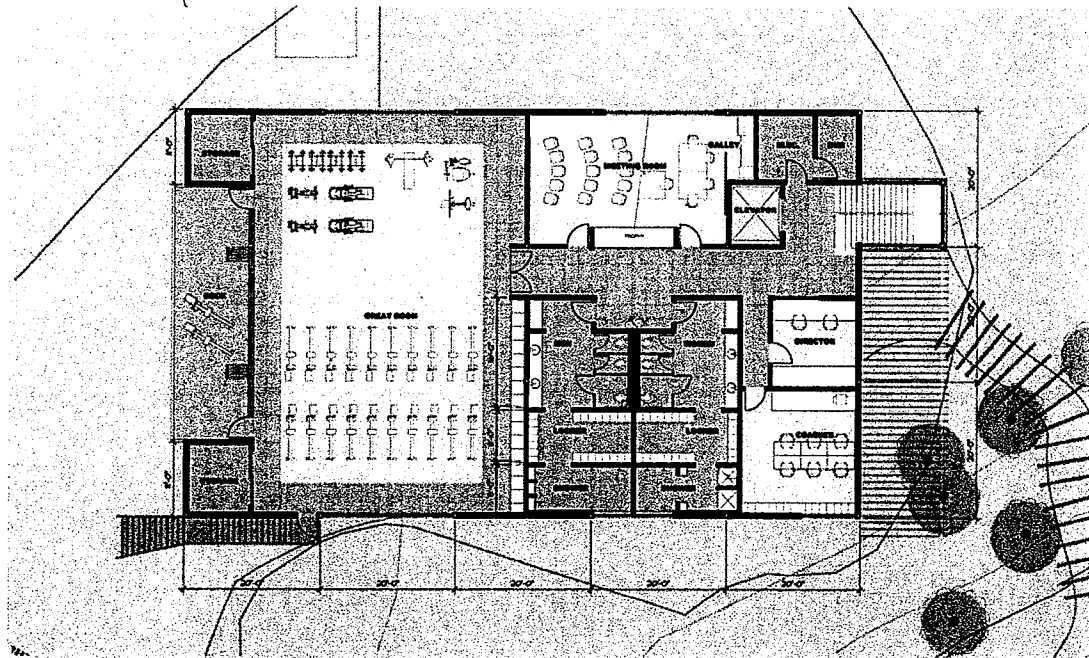
**SAMMAMISH ROWING ASSOCIATION BOATHOUSE**  
EAST ELEVATION



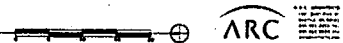


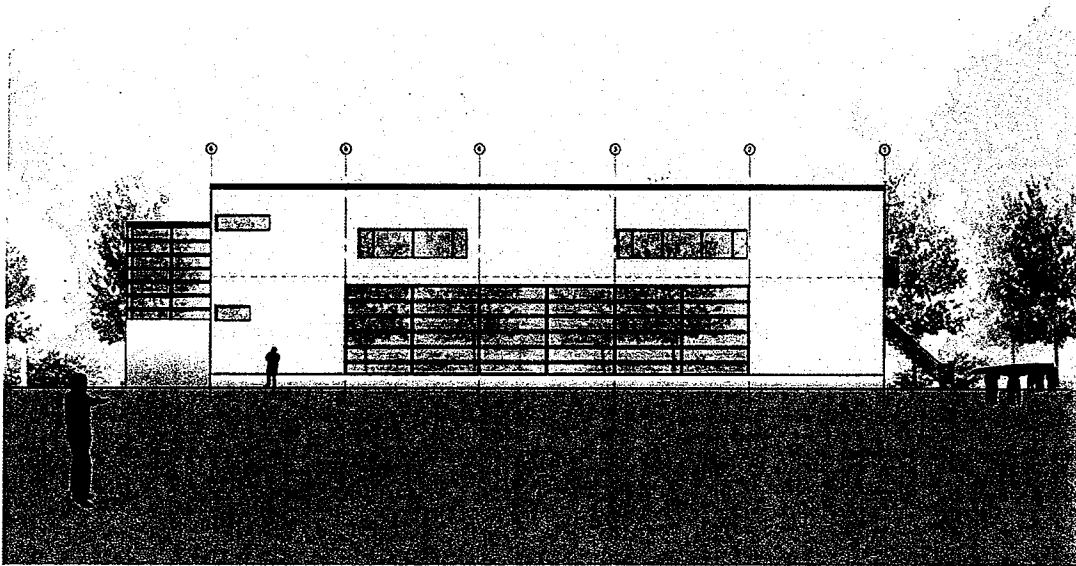


**SAMMAMISH ROWING ASSOCIATION BOATHOUSE**  
BOAT BAY PERSPECTIVE

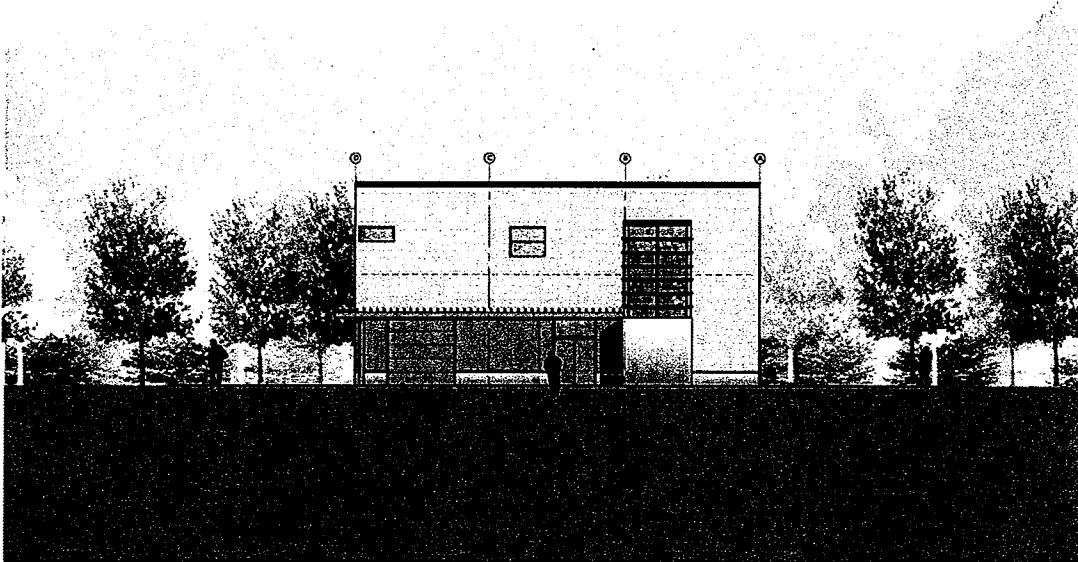


**SAMMAMISH ROWING ASSOCIATION BOATHOUSE**  
SECOND FLOOR PLAN



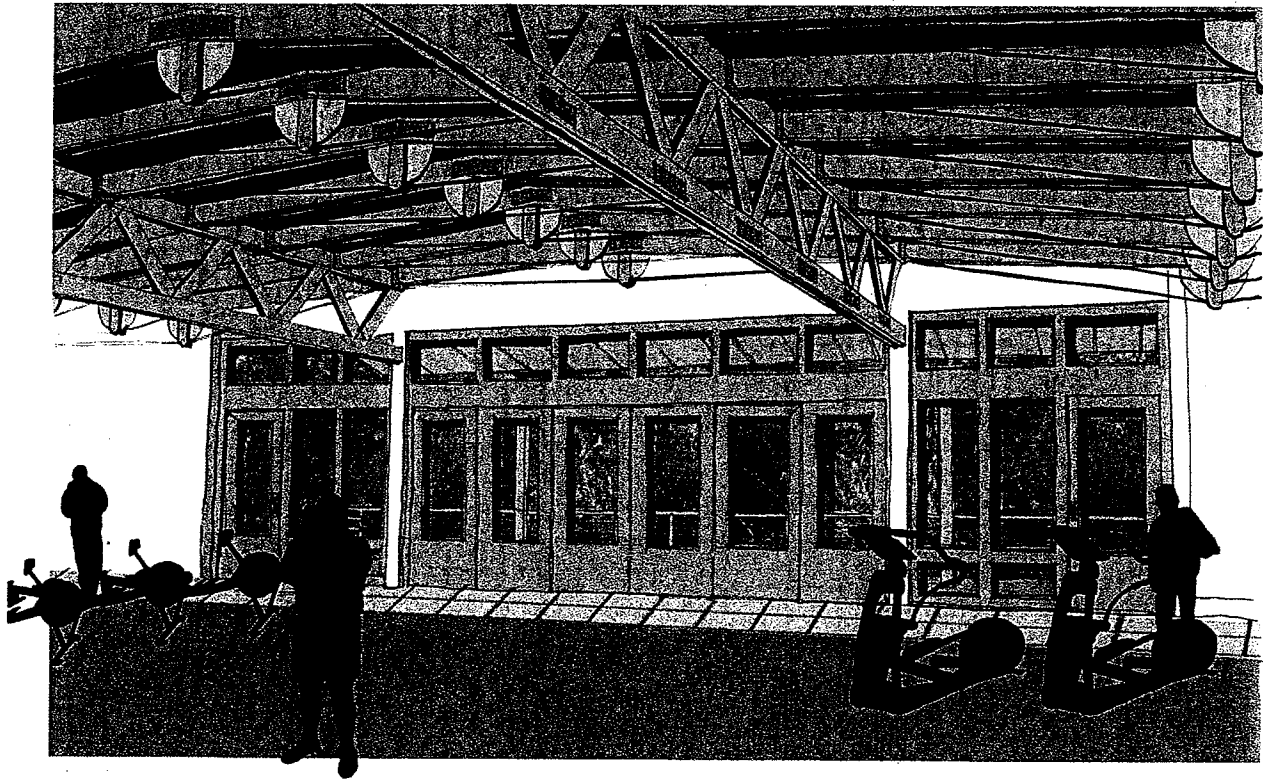


**SAMMAMISH ROWING ASSOCIATION BOATHOUSE**  
WEST ELEVATION



**SAMMAMISH ROWING ASSOCIATION BOATHOUSE**  
SOUTH ELEVATION



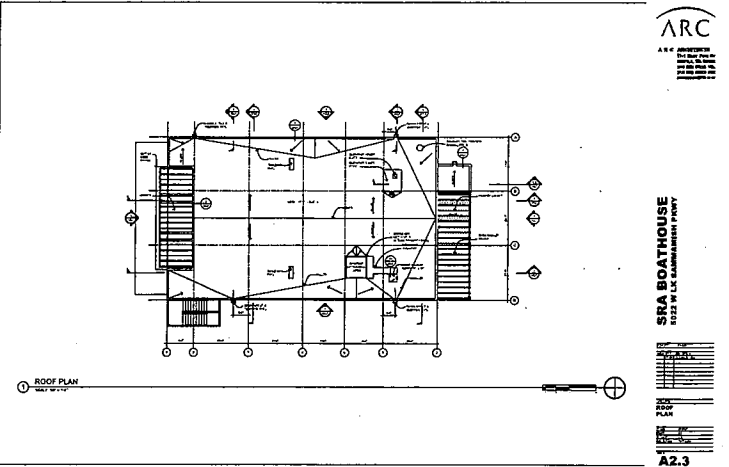
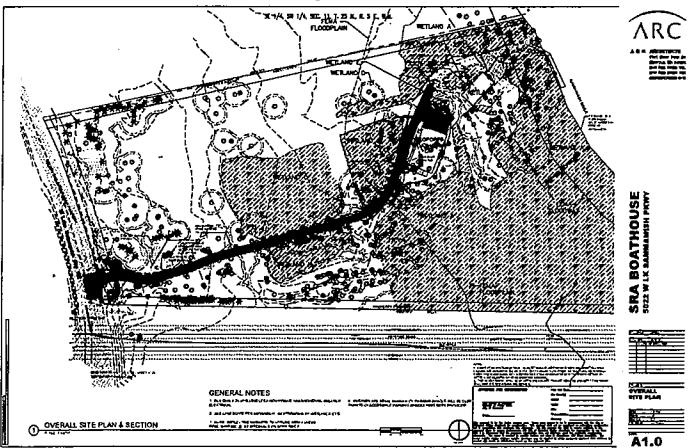
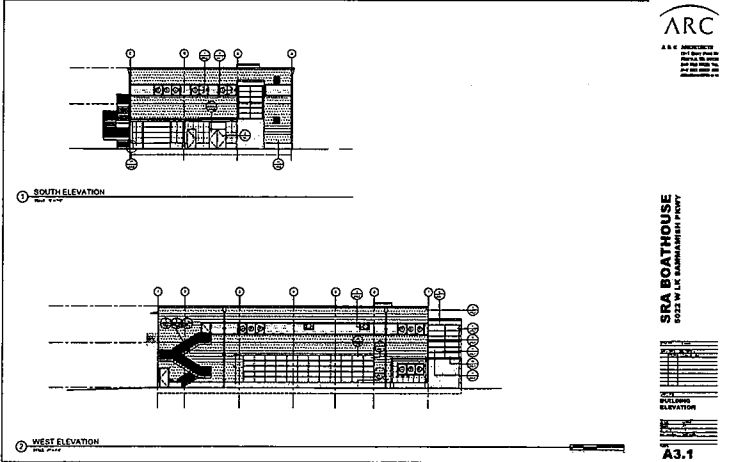
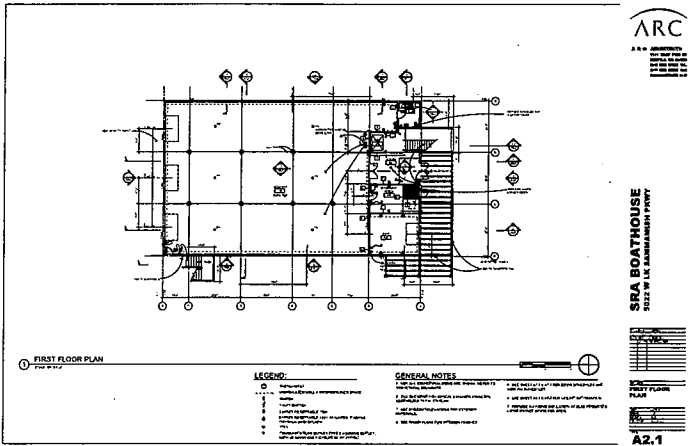
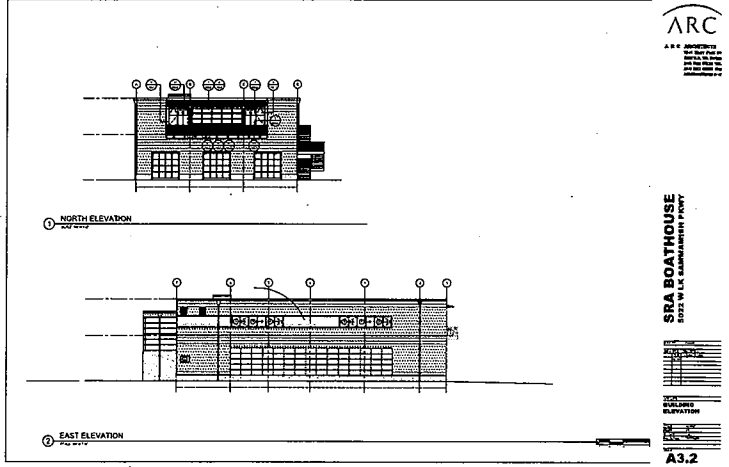
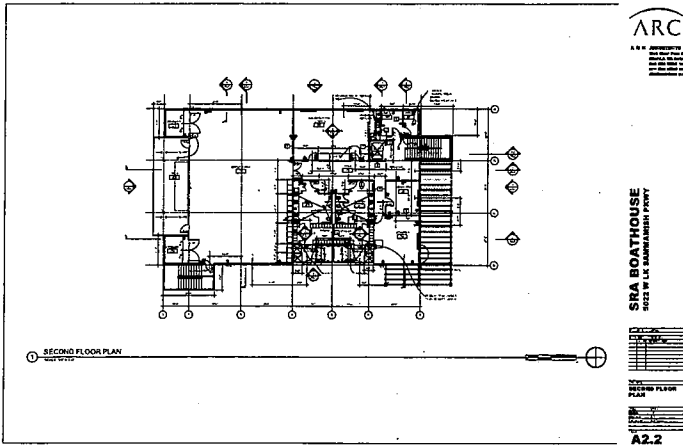


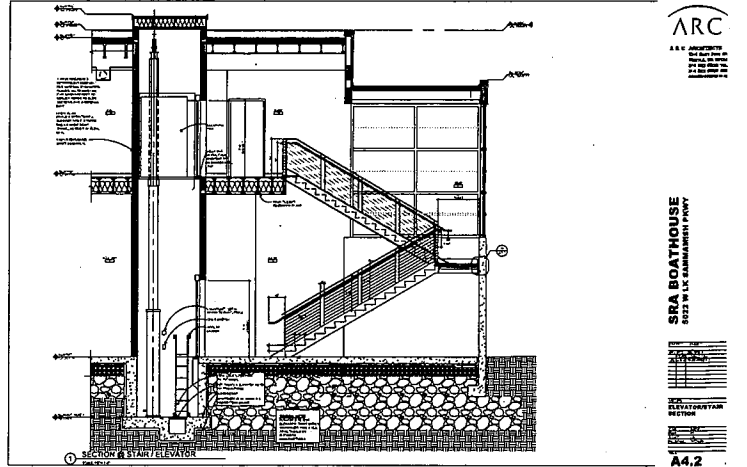
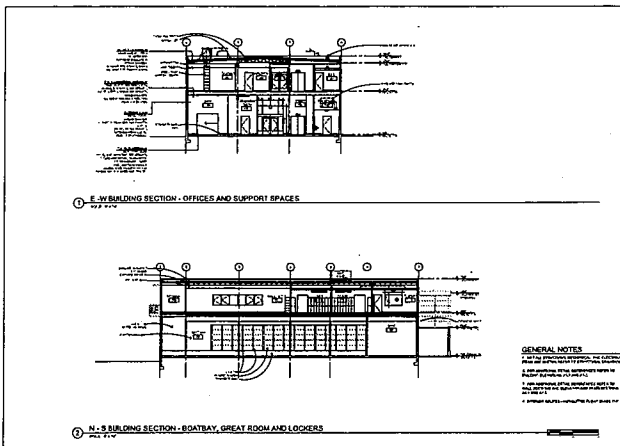
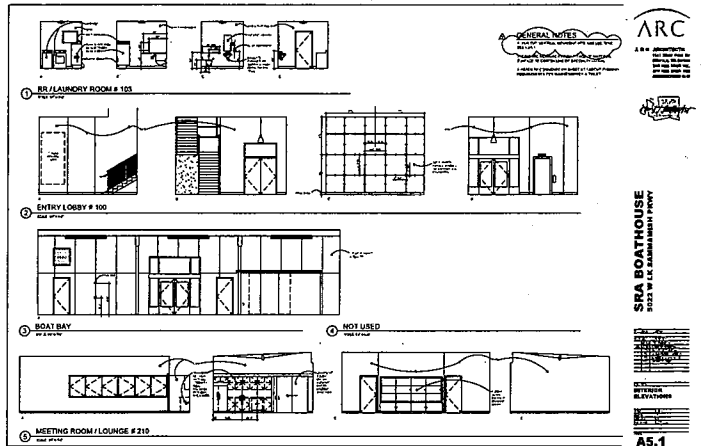
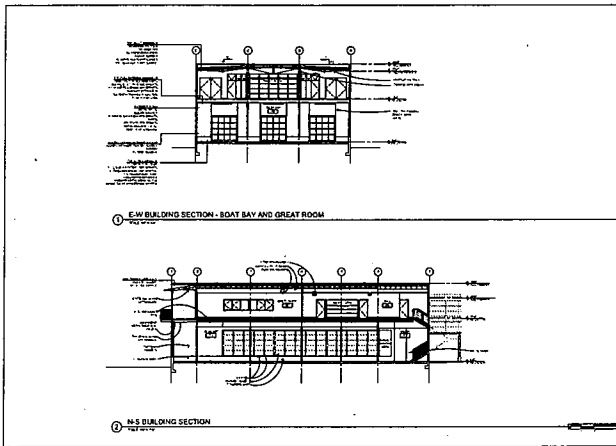
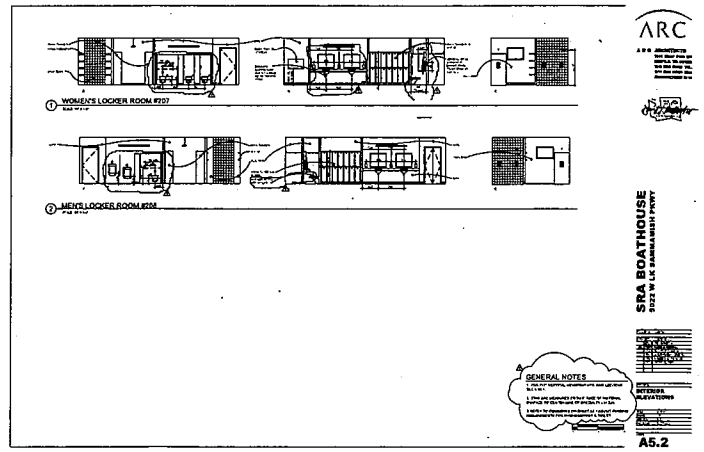
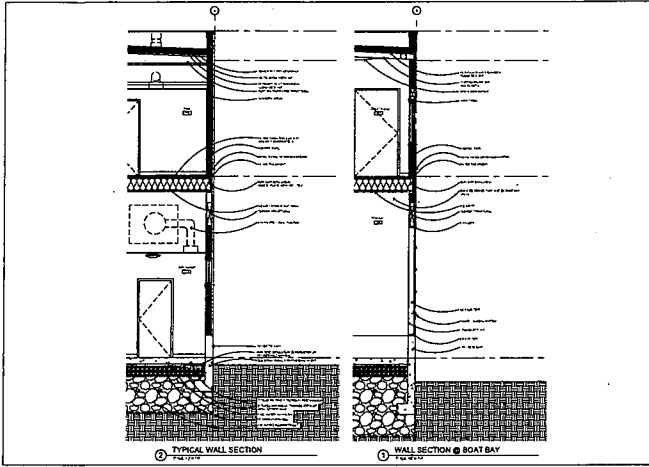
**SAMMAMISH ROWING ASSOCIATION BOATHOUSE**  
GREAT ROOM PERSPECTIVE



**SAMMAMISH ROWING ASSOCIATION BOATHOUSE**  
ENTRY PERSPECTIVE

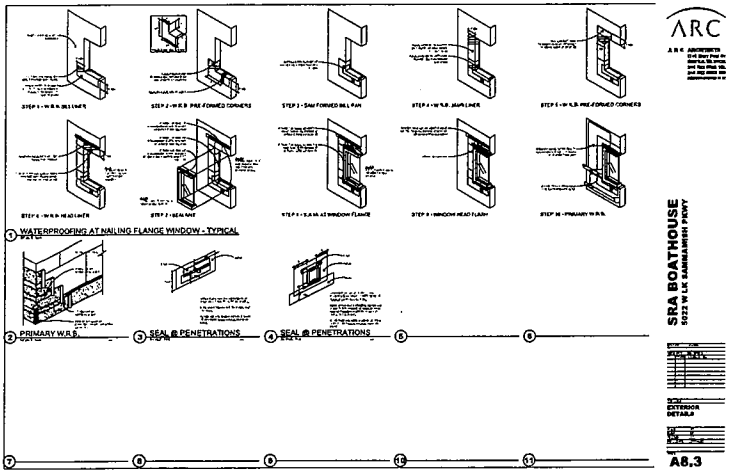
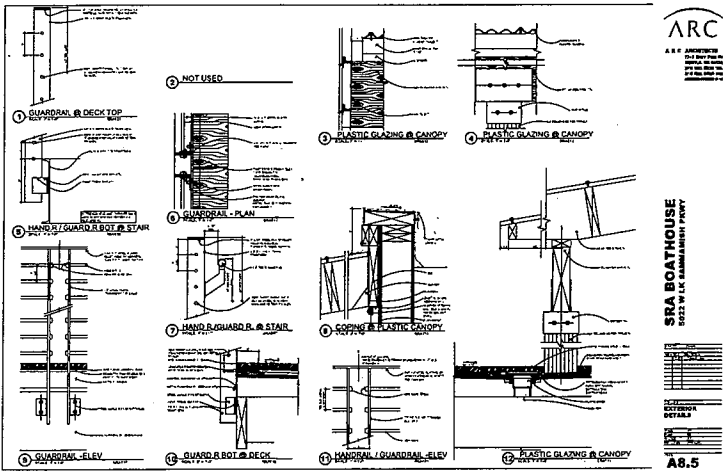
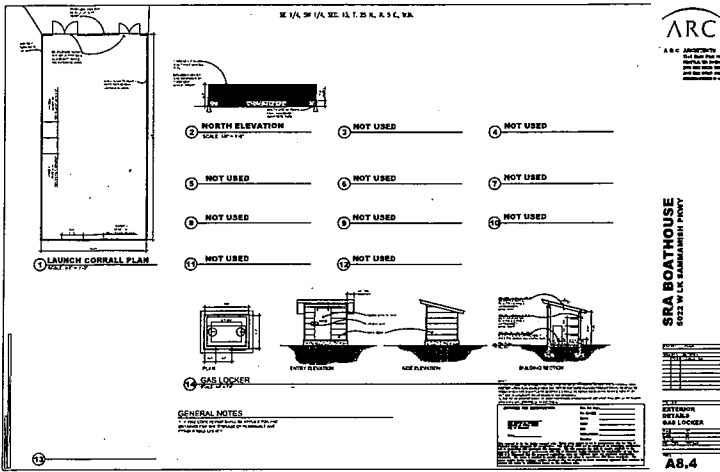








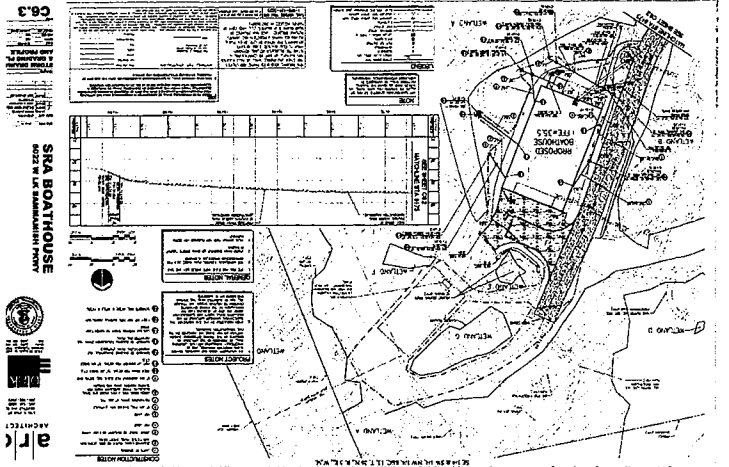
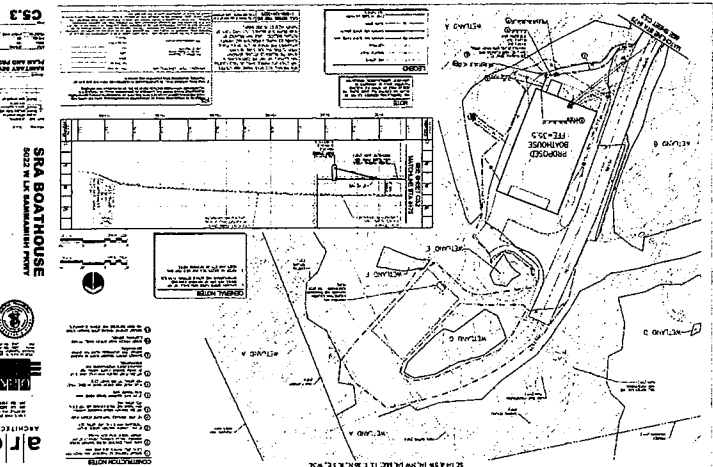
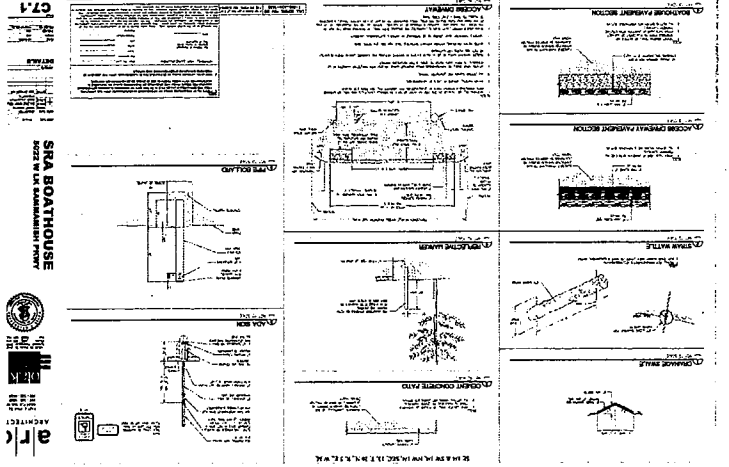
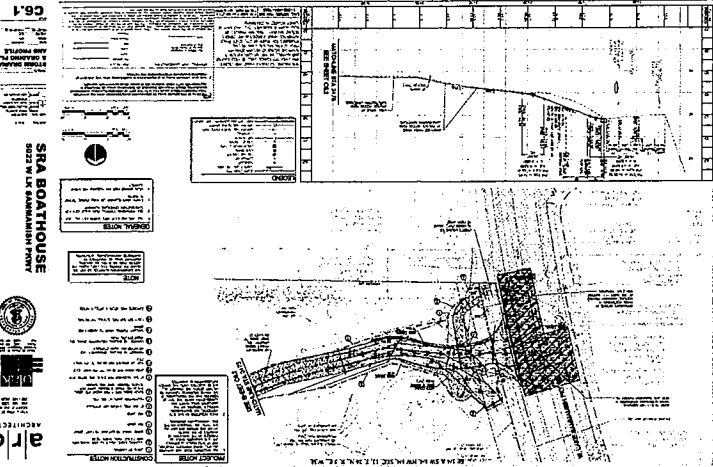
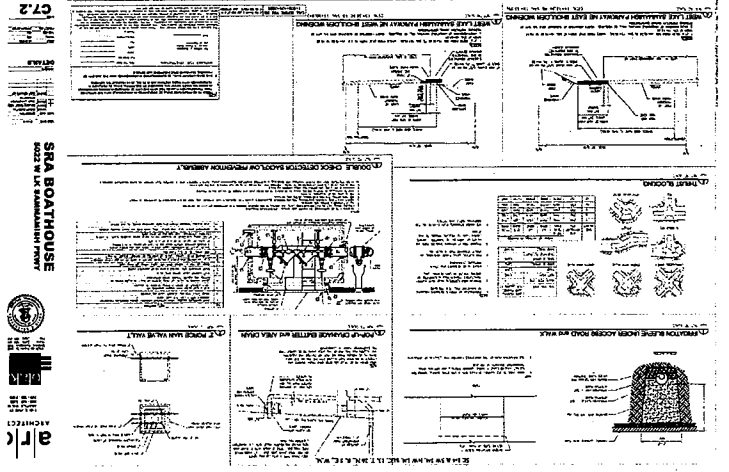
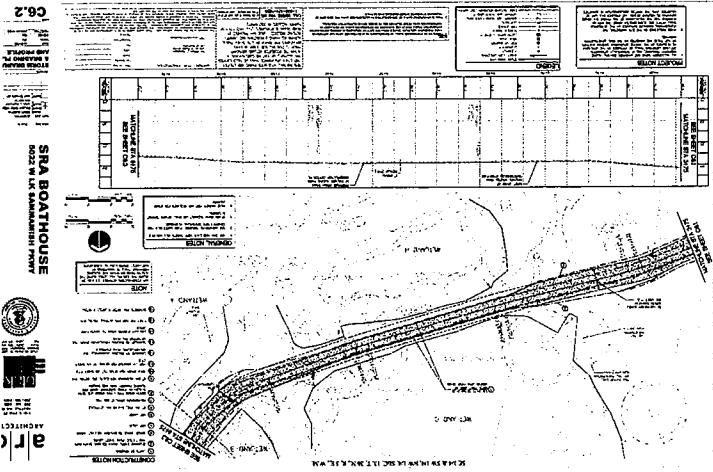












**Exhibit B: Use Policy**

B1 - "SRA Handbook for Parents, Coaches, and Referees"

B2 - Park Programming and Use Rules (to be developed prior to or upon completion of facility)

# Sammamish Rowing Association Rower's Handbook

## Contents

1	Introduction to Sammamish Rowing Association .....	1
1.1	About SRA .....	1
1.2	History of the Association.....	1
1.3	SRA and USRowing.....	2
1.4	SRA Organization .....	2
1.4.1	Board of Directors .....	2
1.4.2	Employees .....	3
1.4.3	Volunteers.....	3
2	Programs and Membership.....	5
2.5	Overview .....	5
2.6	Responsibilities and Privileges.....	5
2.7	Class and Team Details.....	6
2.8	Membership Details .....	7
2.9	Becoming a Member.....	8
3	Rules and Regulations.....	9
3.10	The Why of Rules .....	9
3.11	Safety Rules.....	10
3.12	Boathouse Rules.....	13
3.13	Equipment Rules.....	16
3.14	Regattas – Local and Regional .....	20
4	Procedure Checklists .....	22
6	Appendix B: Lake Sammamish Rowing Traffic Patterns.....	26



## **1 Introduction to Sammamish Rowing Association**

### **1.1 About SRA**

The Sammamish Rowing Association is a 501 (C) (3) non-profit organization community rowing program. We are the only rowing club on Seattle's Eastside. Formed in 1995, we moved into our current boathouse in 1997 located in West Marymoor Park and our organization is in partnership with King County Parks. Our club is open to everyone. Members range from beginners to advanced rowers, from juniors to veterans.

As a young club, we place a special emphasis on adding new members. Our coaches focus on teaching the fundamentals of rowing and making your first rowing experiences positive. We are a fun, friendly group who enjoy the wonderful sport of rowing and each other. Come join us and experience the beauty and fun of rowing.

Up to the minute information about SRA can be found on our Web site:  
[www.srarowing.com](http://www.srarowing.com).

### **1.2 History of the Association**

Ever wonder if those public meetings ever make a difference? Is there a question in your mind as to whether a few folks with a good idea would ever get help from the local Councils, departments and bureaucracies? Well, the story of Sammamish Rowing should warm your heart.

It was in 1995 that some ex-rowers who had heard about an abandoned boathouse showed up at a Marymoor Master Plan public meeting to ask if it could be opened as a community rowing facility. Over the next year, as we were educated about the many challenges of the mission (such as a sewage treatment plant that needed to be removed and a pristine natural site that needed nurturing), we were also coached, supported and assisted into becoming a partner with King County Parks.

It turned out that they had what we needed: the site, a little money, program expertise and many of the permits and processes. And we had what they needed: Volunteers, time, energy, a little more money and rowing expertise. With a great deal of cooperation, tolerance and enthusiasm on both sides, SRA and King County Parks have come together to create a community asset and, hopefully, a model for future public/private citizen partnerships which might enable many other activities almost as wonderful as being in a long boat, moving fast over a flat lake on a clear morning.

### **1.3 SRA and USRowing**

The United States Rowing Association is the governing body for the sport of rowing. Members of USRowing include clubs, universities, high schools and other rowing organizations and individuals. Sammamish Rowing Association is an organizational member of USRowing in the Northwest Region. Many of our rowers are members of USRowing.

### **1.4 SRA and King County Parks**

SRA is a non-profit organization in partnership with King County Parks. As part of this partnership, SRA is a good neighbor and steward of King County Parks working to maintain positive relationships with users of King Parks, the West Marymoor location including the parking lot, trail and dock space and the residence in the nearby neighborhood. SRA assists with maintenance and repairs of the boathouse area. SRA members and rowers respect and follow the rules and regulations as posted by King County Parks.

### **1.5 SRA Organization**

The SRA organization is composed of:

- Board of Directors
- Employees
- Volunteers

#### **1.5.1 Board of Directors**

The Board of Directors manages the direction and financial affairs of the Association. Board members are elected for three year terms at our annual meeting in January. Board meetings are on the third Wednesday of every month at 6:45pm; see the SRA Web site for directions.

Board officers serve one year terms, and are elected by the board at the first board meeting of the year. The officers are:

**President** The President is the principal executive officer of the Association and presides over all Board and member meetings. The President has the authority to sign legal documents and approve payments. The President is committed to following the mission and goals of the Association.

#### **Vice President**

The Vice President acts as President in the President's absence and assists in his/her duties.

**Treasurer** The Treasurer has general charge of the financial affairs of the Association. The Treasurer monitors the financial condition of the Association and gives a financial report at Board meetings and the annual meeting.

**Secretary** The Secretary keeps minutes of the board meetings and distributes them to all Board members and posts them on the SRA web site.

**Staff Liaison** The Staff Liaison is the interface between the Board and SRA's employees. The Staff Liaison (with Board approval) establishes staff pay and benefits.

### **1.5.2 Employees**

SRA has three full-time and several part-time employees.

**Director** SRA's full-time Director is responsible for overseeing the daily operation of the club, staff and Volunteer Committees. The Director works with the Board to establish the goals and direction of the association and, in turn, use these goals to drive the operations, scheduling and activities of the association. The Director develops an annual budget, pays expenses and keeps records of all financial transactions.

#### **Maintenance and Boathouse Manager**

The Boathouse Manager is responsible for the daily management of the boathouse. This includes maintenance of shells, launches and equipment, purchasing of non-capital goods for the boathouse and maintaining repair and boat damage records.

#### **Office Manager**

The Office Manager is responsible for recording and maintaining all SRA membership and class registration. This position also assists the Director with driving the operations, scheduling and activities of the association established by the Board and Director.

**Coaches** SRA employs part-time coaches who are responsible for teaching classes and managing teams. SRA also has volunteer coaches.

### **1.5.3 Volunteers**

SRA is a community rowing program that relies heavily on its volunteer support. All SRA members are encouraged to join in the many activities surrounding the boathouse and our rowing community. Your involvement keeps our club running the way we like it to run, and it is a great way to meet other rowers! Suggestions

are always welcome, and members are encouraged to drop into any committee or board meeting.

Volunteer coordination is provided by **Team Volunteers** and **Volunteer Committees**.

Each rowing team has a set of Team Volunteers:

- At least one **Team Captain** who provides leadership and acts as a liaison between the Board, the Director, the coaches and the rowers on that team.

Volunteer Committees focus on a particular area within SRA and provide leadership and coordination for that area. Each committee has a chair person who serves a one year term. All committee contact information is posted on the boathouse notice board and on the SRA Web site.

The volunteer committees are:

**Safety** Responsibilities include record keeping and maintenance of the: launches, fire extinguishers, first aid kits and other safety items. The committee continues to monitor overall adherence to SRA's safety rules (see the Safety Rules section below).

#### **Community Relations and Advertising**

This committee oversees both the external and internal advertising of the association. It promotes adult and junior class growth, communicates race results and other special events to the press, manages the boathouse notice board, maintains promotional materials and assists in establishing relationships with the neighborhood and Marymoor Park. This committee also works with the members to identify areas of success and areas of needed development within the Association.

**Social** The Social Committee is responsible for promotion of the annual auction and development of all club, family and group activities.

**Sculling** The Sculling Committee is responsible for maintaining sculler membership at SRA, sculling boat purchase recommendations, proper check out of members, facilitating communication between scullers and developing the competitive sculling program.

**Auction** The annual Auction, held in late fall, is our primary fundraiser for new equipment. The Auction Committee is responsible for promotion, planning, procurement and set up of this fun social and fundraising event.

## 2 Programs and Membership

### 2.6 Overview

The Sammamish Rowing Association was established to provide rowing opportunities for all members of our community, from novices to elite racers. SRA has developed a wide range of programs to accomplish this.

SRA programs fall into three general categories:

- **Classes** – SRA classes are organized by:
  - Skill level (Novice, Intermediate, Advanced)
  - Age group (Juniors or Adults)
  - Type of rowing (Team, Independent)
  - Meeting time.

A class is open to anyone with the expertise required by that class; SRA membership is not required. Classes meet regularly 2 - 3 times a week. Class sessions vary in duration.

Classes allow rowers to easily try out different rowing experiences. However, class participants cannot use SRA facilities outside of class times. See section 2.3 for details.

- **Teams** – Teams are longer-term groups organized around a set of classes. Team members typically take these classes on an ongoing basis. Teams often hold activities outside of class – social events, off-water training, races, etc. See section 2.3 for details.
- **Individual Membership** – Individual membership allows rowers to access SRA resources outside of regularly scheduled classes. Both sculling and facility-only memberships are available. See section 2.5 for details.

All participants in SRA programs have access to coached classes, a wide range of boats, ergometers and weight training equipment and other boathouse resources.

### 2.7 Responsibilities and Privileges

The main responsibilities of all individual members and class/team participants are to participate in rowing and Association activities, rules and volunteer in areas that lead to the success and development of SRA.

SRA seeks to provide an atmosphere where anyone can develop their rowing skills to the level they desire and develop a fellowship with other rowers at SRA and within the larger Seattle rowing community.

Membership and class fees are designed to be low as possible, only covering basic operational and coaching costs. SRA relies heavily upon volunteer support for the rest. Your involvement in boathouse projects, community projects, boathouse care and maintenance and the Volunteer Committees is crucial to the success of SRA.

Members and class participants are expected to attend the annual club meeting in January. In addition, all are welcome to attend the monthly Board meetings and Volunteer Committee meetings.

All rowers receive weekly emails about upcoming events at SRA. **If your email address changes, please send your new address to the Director.**

Rowers are encouraged to join the USRowing Association and receive its publications. Membership in USRowing is required for participation in Regional and National regattas.

## **2.8 Class and Team Details**

SRA offers the following classes and teams:

### **Junior Rowing (Ages 13 - 18)**

For experienced and inexperienced alike, this team is open to Middle and High School (Grades 7 - 12) students interested in rowing and coxing. Practices include on and off the water training, and provide the opportunity for regatta participation. A strong commitment and attendance is required.

### **Adult Learn to Row I**

This class is for the beginning rower who is looking to learn the art of sculling. No experience is required for this beginning class. Class size is limited and pre-registration is required. New rowers will learn the sculling stroke in boats with four or more people.

### **Adult Learn to Row II**

Rowers who have completed at least one Learn to Row class will advance to Learn to Row II. This class will continue to teach rowing fundamentals, primarily using the sculling stroke while exposing rowers to a variety of different shell sizes.

### **Experienced Team Rowing**

This team will give you the opportunity to improve your skills and ability as a rower. You will be coached on improving technique and additional rowing terminology. Prerequisites for this team: Completion of Novice Adult, or equivalent rowing experience.

**Competitive Team Rowing**

Perfecting technique and increasing the cardiovascular intensity of each workout will be the primary focus of this team. This team is also for the experienced rower whose focus is competition and a high level of fitness training. A strong commitment and regular attendance are required. Land and water training will be included, and for those who choose to race, workouts will be geared toward regatta preparation. SRA has teams that practice in the morning, mid-day and evenings and weekends.

**Sculling Technique Improvement Class**

This class is for the intermediate to advanced sculler, who is looking to learn or further develop their sculling skills. Sculling experience is required along with instructor permission. Pre-registration is required.

**Competitive Sculling Team**

This program is for the competitive sculler. Intensive training and technical work will be the focus of practice two days a week with the third day being a race day, either at SRA or other regattas

See the SRA Web site for a class schedule and information on registering for a class.

**2.9 Membership Details**

SRA memberships have the following benefits and requirements:

**Membership Benefits**

- Full time access to the boathouse – boathouse access code for the north garage door and for the back door lockbox.
- Ability to reserve and use club singles and doubles within the member's skill level and weight range.
- 10% discount on all team class fees and a 15% discount on all sculling class fees.
- Guest privileges – you are allowed to bring a guest 2 times per calendar year. A Consent and Release form (available from the SRA Web site) must be signed by the guest. Guest boat usage is limited to the intermediate level equipment.

Memberships are based on a calendar year. New members who join mid-year must pay for the remainder of that year. Returning members must pay for the entire calendar year regardless of date of renewal (unless signing up for Summer Only Membership.) Members may pay quarterly if needed.

SRA offers the following membership programs:

### **Adult & Junior Individual Membership**

Annual Fee: \$300. You are entitled to all privileges of the club and use of all club facilities including the shells, ergs, weights and video equipment for the calendar year.

### **Family Membership**

Annual Fee: \$420. Family membership includes up to two adults and two children. Additional children are \$90 per year. All adults and children receive full club benefits. Each family member must have an individual sculling skill checkout in order to use the sculling equipment.

### **Summer-Only Membership**

Monthly Fee: \$30. Rowers may sign up for membership monthly or in a 3-month block between April and September each year. Rowers must successfully complete online e-checkout or physical checkout (required for all first-time members.) Summer members do not receive class discounts.

### **Facility-Only Membership**

Annual Fee: \$100. Facility-Only membership allows use the boathouse and the land training facilities without access to the sculling equipment. You are still allowed to row sculling boats in any class you participate in. Facility-Only members do not receive the discount on class fees.

### **Boat Storage**

SRA offers private boat storage at an additional fee to existing members. However, all storage slots are taken at this time, and we are planning on using any future spots for club equipment. We will notify members if this situation changes.

## **2.10 Becoming a Member**

The following steps need to be taken to become a member:

**Registration** The individual must complete the following forms

- SRA Consent and Release form. Good for 1 year.
- SRA Float test. Good for 5 years. The Float Test must be taken at a pool and signed by a certified Red Cross Lifeguard.
- USRowing waiver- even if an SRA member is **not** a member of USRowing, we still need this waiver to be signed each calendar year for insurance purposes.
- Medical form- members should be sure to list any health concerns and allergies.



These forms can be found on the SRA Web site. Both forms, along with a minimum deposit must be completed before membership is valid.

**Safety Checkout**

All new members must be checked out by the Director, Head Sculling Coach, or other authorized staff member. Safety checkout consists of a review of all rules, a tour of the facility, details on the type and location of all equipment, and an orientation to the organization of the Association along with a discussion of the SRA rowing safety rules. All rowers must acknowledge and sign that they have read the rules and that failure to follow these rules will result in the removal of membership from SRA

All returning members must be re-checked out each year via e-checkout, which includes a comprehension exam. Rowers must score 100% on this exam to be considered 're-checked out'. Rowers may take the exam as often as needed to pass with 100%.

**Sculling Skill Checkout**

All rowers must pass a skill checkout to row a certain level of equipment. This on the water rowing test consists of basic safety, rowing, and equipment handling necessary to row at SRA. To move up in a level, another Sculling Skill Test must be completed. Rowers are not allowed to use equipment that they have not been checked out on.

Additionally, all rowers must pass a flip-test to be eligible for membership. Flip tests are good for five years, and are generally administered in a beginning level sculling class or at a physical sculling checkout.

**Admission** Once all paperwork and funds are collected, the checkouts are completed, the member will receive the code for the boathouse along with a personalized sculling card located on the sculling desk in the boathouse. The access code is not to be given to any non-members. The access code will be changed at least once every other year.

### 3 Rules and Regulations

#### 3.11 The Why of Rules

The sport of rowing has two key ingredients, people and equipment. Our rules are intended to:

1. Ensure the safety of all rowers
2. Offer a high quality rowing experience
3. Preserve the equipment

Everyone participating in SRA programs must obey a common set of rules and guidelines in order for all of us to achieve these objectives. Feel free to question any rule until you understand the rationale behind it. But please observe the rule in the meantime.

These are general rules and regulations for all members and rowers to follow at the boathouse. Specific Sculling and Sweep rules will be addressed in subsequent sections.

#### 3.12 Safety Rules

**Head's Up!** The most fundamental safety rule is to be constantly aware of what is going on around you. **LOOK AROUND** at least once every ten strokes when in an un-coxed boat or if you are a coxswain. In the slough you should look around every 3 strokes. It is easy to get lulled by the rhythmic nature of rowing, but do not let your eyes rest inside the boat.

Before you row, look in the card rack to see what other rowers/classes are out. Keep your eyes open for them when you are on the water. Also be aware that additional rowers may have headed out onto the lake since you left the boathouse.

#### Traffic Patterns

Most of Lake Sammamish is unrestricted rowing. However, there are a few areas that have fixed rowing traffic patterns (see Appendix B for a traffic pattern map):

- **The Dock.** Northbound boats must always row past the dock, turn around and then row into the dock. Stay in order – do not cut ahead unless you get explicit permission from all the boats in front of you. If the dock is full, stay out beyond the dock with at least 10 feet between boats. **Boats that are docking as part of a class always have precedence over boats that are launching as part of a class. Class boats**

**that are launching should wait until all boats on the water have docked before proceeding to launch.**

- **The Slough.** The slough area is between the dock and the waterskiing course. Be extremely vigilant when rowing in the slough – it can get lots of traffic and is very narrow in the summer when lily pads line both sides.

You **must row on the paddle** at all times when in the slough.

Do not overtake other boats unless you get their explicit permission.

Stay to the starboard side of the slough when you encounter boats going in the opposite direction.

Southbound traffic (*leaving* the slough) has precedence over northbound traffic (*entering* the slough) – northbound traffic should move to the side and let southbound traffic pass if there isn't room for both boats.

- **West side of lake, between the ski course and the Point.** Southbound boats should stay inside the buoys; northbound boats should stay outside the buoys. The northbound lane of the traffic pattern is 3 boat widths wide.

Boats that are outside the traffic pattern must row down the middle of the lake, staying well clear of the traffic pattern.

### **Leave a Record**

If you are rowing without a coach, you must always put your card on the rack and sign out in the logbook before you leave the boathouse. The principal purpose of the rowing logbook is to alert others to the possibility that you may be in difficulty somewhere. Remember to sign in and put away your card when you return.

**Launches** All launches should have the following items: Life Jackets, toe line, fire extinguisher, paddle, gas can, megaphone, kill switch, working radio, blanket, first aid kit and tool box.

The launches are checked every week by the safety committee. However, it is also your responsibility to check over the launch before putting it into the water.

Make sure an experienced person is helping every time a launch is put into the water. Do not put one in if you do not know how to properly launch the launch or if it appears that the launch trailer is broken.

Individuals should not use the club launches for any reason. Coaches and board members are the only ones permitted to use a launch.

**Lifejackets** All launches have at least 9 Coast Guard certified lifejackets. If the boat swamps or you flip into the water you will be asked to wear a lifejacket until you are pulled from the water by the safety launch.

SRA provides non-Coast Guard certified lifejackets for scullers rowing singles and doubles. Any member going out in a single without another rower or coach, regardless of temperature or daylight, must wear a life vest (preferably a fanny pack style if available or the chest style.) Members rowing with other singles or in a double, without a coach, must carry a lifejacket in the boat and do not need to wear it unless needed.

### **Flipping or Swamping**

If a sculler flips out of a Beginning or Intermediate boat you can re-enter it on the water, but you must **never** attempt to re-enter an Advanced or Racer 1x on the water; this will cause significant damage to the boat. You must swim these boats to shore as shown in the safety video and re-enter it from there.

If you flip boats on a regular basis, then you are probably rowing in boats that are at too high a level. It is very difficult to improve your sculling skills under these circumstances (not to mention that flipping causes a great deal of wear and tear on a boat). Therefore if you flip two times in two months, you must go down a skill level. Please inform the Director or Sculling Coach if this occurs. After you have rowed for a while at the lower level, you can take another skill checkout and be re-certified for your previous level.

If a four or eight is flipped or swamped you must remove the oars, turn over the boat and wait with the boat until the safety launch arrives. **Never** try to swim to shore without the boat. If an individual rower flips out of a multi-person boat then the boat should weigh enough, undo an oar and gently push it towards the rower so they can use it as their floatation device. If possible, the rower should climb back into the shell, or re-enter the shell from the launch.

**Always put a note in the comments field of the rowing log when a sculling boat has been flipped.**

### **Water Hazards**

Lake Sammamish is a busy urban lake. You may encounter other shells, canoes, kayaks, motor boats, floating debris, deadheads, and other hazards. Be especially aware of:

- **The waterskiing course.** Water-skiers have the right of way on the course. If a ski boat is on the course, wait until it has passed you and is heading east up the course before crossing.
- **Shoreline hazards.** There are numerous docks, floating swim platforms and buoys along the shore.
- **Buoys/Water monitoring stations.** There are many large buoys on Lake Sammamish. There is also a large floating water monitoring station in the middle of the lake toward Issaquah.

**Darkness** Always use lights when rowing in the dark. Club lights are stored under the phone. You must have a bow and stern light in all boats.

**Weather** Use common sense and know what you can comfortably handle. Rowing in heavy waves is structurally hard on our boats and requires better than average technique. Rowing is prohibited under the following conditions:

- **Whitecaps.** If there are whitecaps on the lake when you come out of the slough, turn around. If whitecaps develop while you are rowing, head for shore and find calm water or a beach.
- **Thunder and lightening.** Never row when there is the possibility of lightening. Do not start a row if you hear thunder; wait at least 30 minutes. If you hear thunder when you are out on the water, immediately head for shore.
- **Fog.** Do not row in fog. If you cannot see at least 50 yards, then you shouldn't start a row.
- **Freezing temperatures.** Do not row alone if there is snow on the ground or ice at the edges of the water.

**Wakes** Large wakes from motorboats (especially wake boarders) can leave you half-swamped. When possible, turn the boat parallel to oncoming wakes to minimize hull stress and water intake. If

swamped in a single or double, try bailing with your water bottle. If that doesn't work, head for shore to empty the boat.

### **Safety Review Checkout Meeting**

The USRowing Safety video will be shown to all classes at the start of each season. All rowers are required to see this video and to understand and follow the safety procedures established by the United States Rowing Association. At this time we will also review the SRA specific safety rules established in this handbook.

Independent scullers must attend a safety review checkout meeting once a year, where you will see the safety video and review the rules and procedures.

## **3.13 Boathouse Rules**

### **Parking Lot Traffic**

Entering and exiting SRA grounds must be as orderly as possible in order to avoid accidents. Please do the following:

- Enter the parking lot through the South gate and exit through the North gate.
- Beware of bicyclers, runners, walkers, etc. when exiting the parking lot. Be sure to look both ways.
- Don't ever park on W. Lake Sammamish Parkway, even short-term.
- Please don't drive down the gravel path the boathouse unless you are transporting something too heavy to carry.
- Do not park blocking the entrance to this path; it must remain open for emergency vehicles.
- Be sure to pay your Marymoor Park parking fee (either daily at the pay station or by purchasing a parking pass through Marymoor Park.)

All rowers are highly encouraged to carpool to the boathouse. We have very limited parking. Each team may choose to establish either a carpooling system from Marymoor Park or another location or may double park their own rowers. Please check with your team if there are special considerations regarding parking.

### **Key and Access Code**

Keys and/or the garage door access code are given to club members, coaches and board members. The key will unlock both gates and the bollards blocking the gravel path to the boathouse. The access code will let you into the boathouse via the big bay

door. The access code will be changed at least once every other year.

Keys must not be copied and the access code should not be given to other rowers or friends. Abuse of this rule will lead to your membership being revoked.

There is key hanging just to the right of the biggest bay door (standing inside the boathouse, looking out) which may be used by any rower in case of emergency. **Rowers should know to use this key to unlock the metal swing gate at the top of the path to allow emergency vehicle access.**

### **In the Boathouse**

All rowers must be **quiet** in the boathouse when boats are being moved. Please refrain from talking or yelling so that coxswains and/or coaches can be heard when equipment is being moved.

Rowers must behave in a courteous and responsible way towards all other rowers and coaches.

### **Rower and Launch Cards**

Every rower that is allowed to scull independently has a laminated card that contains the rower's current skill level, emergency information, etc.

Every time a rower goes out, he/she must put their card up on the card rack. Please remember to put the cards away when you return from a row.

### **Lock the Boathouse while Rowing**

Always set up slings outside the boathouse and lock all three boathouse doors while you are out rowing. The last person out of the boathouse has the responsibility of securing the boathouse. If you are not sure that you are last person, secure the boathouse anyway (a rower can always use the garage door code to get in if necessary).

**At the Dock** Move along smartly when launching and landing. If other boats want to use the dock, try to launch within 60 seconds of putting your boat in the water. This means making as many adjustments as possible prior to taking it down to the dock, tying in when on the water, etc. When landing, please also be prompt about getting off the dock and putting your equipment away.

Please bring down all equipment, water bottles, etc. to the dock before launching the shells so you are not delaying launching of the shells by running back up to the boathouse for something.

Shoes, extra clothing, etc. must be put on the land side of the dock so they are out of the way of rowers launching their boats.

### **Leaving the Boathouse**

Make sure all equipment is properly stored away, all launches are inside the boathouse with their radios turned off, and all gas containers have been put in the outside locker.

Be sure to take all clothing, water bottles and other personal items with you when you leave. Put all garbage into the trash bin at the West end of the boathouse.

If you are last one out of the boathouse, turn off the lights (outside light switch by the big garage door, inside light switch by the rear door). Turn off the boathouse radio. Make sure all three doors are locked.

### **Cleanliness of the Boathouse**

All rowers are responsible for maintaining the cleanliness of the boathouse. This means picking up water bottles, trash, as well as putting all equipment back in its proper location. We do not have any janitorial services; therefore, all rowers must take responsibility for keeping the boathouse clean and organized. If you do not know where something goes, just ask!

### **Boathouse Cleanups**

All rowers are required to participate in at least 2 boathouse cleanups per year. These are scheduled and posted on the Web site and at the boathouse.

## **3.14 Equipment Rules**

**Boat Usage** SRA members and teams can use any club single or double that is in their skill category and weight class. Teams are allowed to use the fours and eights as well. Skill categories are determined by an on-water skill checkout with the Director or the Sculling Coach or Team Coach. The skill categories are:

- Beginner
- Intermediate
- Advanced



- Racer

See the boat chart in Appendix A for a list of the boats in each category and rules for specific boats.

There are several private boats stored in the boathouse. DO NOT USE private boats, oars or parts from private boats. When in doubt, don't use it!

### **Quad Policy**

SRA members can only use club quads when accompanied by a SRA coach providing on-water supervision. Quads must be reserved in advance and arrangements must be made with a SRA coach prior to a row. All rowers in the quad must be SRA members or receive director or coach approval prior to the row. There must be at least two rowers who are at the Advanced level in the boat. Quads must be equipped with a designated radio to communicate to the on-water coach for safety purposes. Junior SRA Members (18 and under) are only permitted to use quads during their scheduled class times.

The quad may launch if a coach is already on the water or intending to launch shortly. The coach must be notified prior to the quad launching. If a coach is already on the water, the quad members must radio her/him to inform them that they are launching. If the quad launches prior to the coach and the coach decides not to take the class out on the water, the coach will notify the quad and the quad must return to the dock. If the quad returns to the dock before the coach, the quad members must radio to the coach to let her/him know they are returning.

### **Four Policy**

SRA members can use club coxed fours under the same policy as the club quads. **Coxless fours are not allowed without DIRECT coach supervision.** In this case a coach must be hired for a private lesson by the rowers.

Under special circumstances (i.e. training for an upcoming regatta) rowers are allowed to join a scheduled rowing class when some or all of the rowers are not part of the class. Rowers must have prior coach approval/permission. Rowers who are not a regular part of the class must pay a fee equivalent to the cost of one class.

No equipment is to be removed from the boathouse without permission from the Director or Boathouse Manager.

**Oars**

All sweep oars are club owned. However, there are both club owned and private sculling oars in the boathouse. Private oars are in the rack furthest from the door. Be sure that you are using club sculling oars – all club oars are painted with club colors.

Club sculling oars are organized into sets that have the same length and inboard settings. These settings are clearly marked on the oars. **DO NOT** change the settings of the club oars.

Sculling oars should be carried **BLADES FORWARD, TIPS UP**, and rested **TIPS UP** while on the dock. Roll your oars to the tips up position when you come onto the dock. This ensures that the oar tips never get dragged along the abrasive no-skid surface (which causes the tips to be literally sanded off the oars over time).

Sweep oars should be carried **BLADES FORWARD, TIPS UP**, and rested **TIPS DOWN** while on the dock. Make sure your oar does not get caught on the edge of the dock before launching.

**Boat Reservations and Priorities**

Members can reserve club singles and doubles up to 2 weeks in advance via the Reservation Calendar. You forfeit your reservation if you are not in the boathouse within 15 minutes of the start time. Always check the reservation book to see if someone else has signed out the boat.

Races and regattas attended by SRA as a club have the highest priority for equipment use.

Members can reserve a club boat for a non-SRA race (such as Sound Rower races). However, permission must be first obtained from the Director.

Team classes have priority use of eights and fours. Learn to Row classes have priority use of beginner-level singles, doubles and all quads (except racer-level.)

Members have priority to reserve the use of singles and doubles over team classes (classes must check the reservation calendar before taking out sculling equipment.)

However, sculling classes and Junior classes have priority over members for sculling equipment (members should check with the coaches of these classes if they wish to use a sculling boat during a class.)

### **Handling Equipment**

Be scrupulous about checking the condition of boats and oars before going out on the water. It is your responsibility to make sure the equipment is working before you go out on the water.

DO NOT change non-adjustable equipment settings – seat track positions, rigger positions, oar length and inboard settings, etc.

Scullers, please move all launches or other equipment out of the way before trying to carry a shell. If need be put slings in the boathouse to help you remove a shell. Do not lift a shell if you are going to hit any other equipment.

### **Moving Boats**

All boats should be carried very carefully and should not hit any other equipment. If other equipment is hit, that boat will need to review boat handling skills for a portion of the class time.

### **After the Row**

Put the boat in the slings you left outside the boathouse. Wipe down the top and bottom surfaces of the boat with a towel and put the wet towel on one of the drying racks. Return all equipment and tools to their original location in the boathouse.

Towels do need to be washed at least once a week. Please take it upon yourself to wash them once in a while.

### **Out of Order Equipment**

A boat should always have a “tight” and responsive feel. If anything in the boat feels loose or is noisy or has some “give” to it as you row, STOP and FIND OUT what is wrong. If you or the coach knows how to repair it correctly, then fix it.

However, if you or the coach can't fix the problem, return the equipment to its place in the boathouse and put a “DO NOT USE” sign on it. Put an entry into the repair log explaining what is wrong. Be sure to leave your name in case the repairperson needs to clarify the problem.

We can only fix the problem if we know about it!

**Avoidable Equipment Damage**

SRA equipment gets heavy use, and damage from ordinary wear and tear is considered "no fault", UNLESS you do not report it.

However, you may be held liable for any avoidable damage that you cause to SRA equipment.

**Other Equipment**

SRA has ergometers and free weights available for use by members and class participants at any time, as long as they are not needed for a class.

Please don't use the free weights alone, however. Someone should spot you or be in the boathouse whenever you are using weights.

### 3.15 Regattas – Local and Regional

#### Entry Forms

A list of the regattas SRA will attend each season can be found in the calendar section of the website.

Entry forms for these regattas are distributed to team coaches at least 3 weeks prior to the entry deadline or as soon as they arrive. Members that wish to race sculling boats are also encouraged to sign up. However, all regatta entries must go through SRA. **Please do not send in individual requests, regatta organizing committees will only recognize one contact person from each club.**

Entry forms must be turned in to the Director (or listed person) by the posted deadline. You will be notified of the regatta fee and expected to pay that fee before the regatta.

Members who wish to compete in non-SRA regattas (i.e. Sound Rowers races) may do so. Please complete the entry forms yourself and make all arrangements for entry fees, transportation, etc. To reserve a boat for the race please check with the Director.

#### Regatta Fees

Regatta fees are determined by race entry fees plus trailer expenses, food, coaches and other costs.

Class coaches and Team Captains will be notified of the per person regatta fee at least two weeks prior to the regatta. All fees must be turned in to the Director prior to the regatta.

#### Boat Selection and Reservations

Coaches and members should specify their first and second choices of boats and oars for each race, and their top priority race.

In the case of equipment conflicts, we will try to get everyone their desired equipment for their top priority race.

You will only be able to race equipment that you are checked out to row.

**Transportation to Regattas**

All SRA equipment will be transported to regattas on the club trailer. Private equipment can be transported to a regatta on the trailer if there is room.

If you are participating in a regatta you must also participate in the trailer loading and unloading events. It is your responsibility to ensure that the shell you are using is loaded onto the trailer correctly and unloaded and put away properly at the boathouse.

## 4 Procedure Checklists

This section contains checklists for the most common SRA procedures.

### Classes - Before the Row

- Thoroughly check boats. Make sure rigger nuts and other rigging hardware is secure.
- Put two gas tanks in each launch the class will use.
- Make sure safety and repair equipment is in all launches.
- Coxswains should carry a tool pouch.
- Will it be dark during the row? Coxswain and bow rower must wear lights.
- Put launch cards in the card rack.
- Lock up the boathouse before going onto the water.

### Classes - After the Row

- Any problems with equipment on the water? Report it in the repair log and put a "Do Not Row" sign on the boat if necessary.
- Wipe down all boats. Hang the used towels on the drying rack.
- Remove gas from launches and turn off the launch radio.
- Lock the gas locker.
- Bring all launches into the boathouse if there isn't another class after you.
- Put away all SRA equipment you carried out (cox boxes, seat cushions, etc).
- Remove launch cards from the card rack.
- Throw away trash.
- Turn off lights (both inside and outside) and the radio.
- All class participants should check that they have all their personal items (clothing, water bottles, etc) when they leave the boathouse.
- Lock up the boathouse.
- Lock the parking lot gates if you are the last class of the day.

### Land Exercises - Before the Workout

- If you are using weights, be sure there is someone in the boathouse at all times

### Land Exercises - After the Workout

- Return all equipment to the proper location (ergs stacked, weight in racks).
- Remove all personal items from the boathouse (clothing, water bottles, etc).
- Throw away trash
- Turn off lights (both inside and outside) and the radio
- Check that you have all your personal items (clothing, water bottles, etc) when they leave the boathouse.
- Lock up the boathouse.
- Lock the parking lot gates if you are the last one out of the boathouse in the evening.

**Individual Rowers - Before the Row**

- ☑ Check the reservation book to be sure the boat is available for use if you did not reserve it.
- ☑ Sign the Rowing Log with your name, the boat you will be rowing, and the start time of your row.
- ☑ Find your card in the members card box and place it in a slot of the oar handle that is hanging on the message board. Please note other rowers and classes that are on the water.
- ☑ Move launches out of the boathouse if needed for accessing boats. The launches may remain outdoors during your row.
- ☑ Take oars, life vest, water bottle, and other items you will need for your row to the dock.
- ☑ Put slings up outside the boathouse and put your boat in the slings.
- ☑ If another person is present and available, ask for help getting the boat out of the rack, carrying the boat by tow ends, and placing it in the slings. If you are alone, use great caution getting the boat out of the rack and then place it into slings.
- ☑ If it is dark, secure lights on the stern and bow of your boat. Wear a flashing light on the back of your clothing.
- ☑ Thoroughly check your boat for damage and rigging. Make sure rigger nuts and other rigging hardware is secure.
- ☑ Adjust the footstretchers and removable rigger spacers.
- ☑ If no one else is at the boathouse, close and LOCK all bay doors and lock the main door entrance.
- ☑ Use the port-a-potty if necessary.
- ☑ Take your boat to the dock. If rowing a double, spin the boat before heading to the dock. If there are other people launching, limit your time on the dock to one minute. Adjust footstretchers on the water, NOT the dock.

**Individual Rowers – On the Water**

- ☑ When going through the slough, yield to incoming traffic and stay to the starboard side of the slough.
- ☑ Check the water conditions of the lake before entering. Determine if your skill level and the boat you are using are adequate for the conditions.
- ☑ Stop to check for water skiers before crossing the ski course at the mouth of the lake. If there is a water skier and they are east bound, it is safe to cross. If they are westbound, wait for them to ski around the wooden post and are east bound past your location before crossing.
- ☑ Do not stop on the ski course.
- ☑ Once past the ski course you may stop and make any adjustments needed.
- ☑ Follow the traffic pattern. Scullers are to stay along the shore going inside the buoys when southbound and outside the buoys when northbound. Stay clear of the center of the lake. This area is reserved for the classes and especially the sweep boats.
- ☑ Turn around and look often. There are several buoys that need to be avoided, in addition to any other boats that may be on the water.



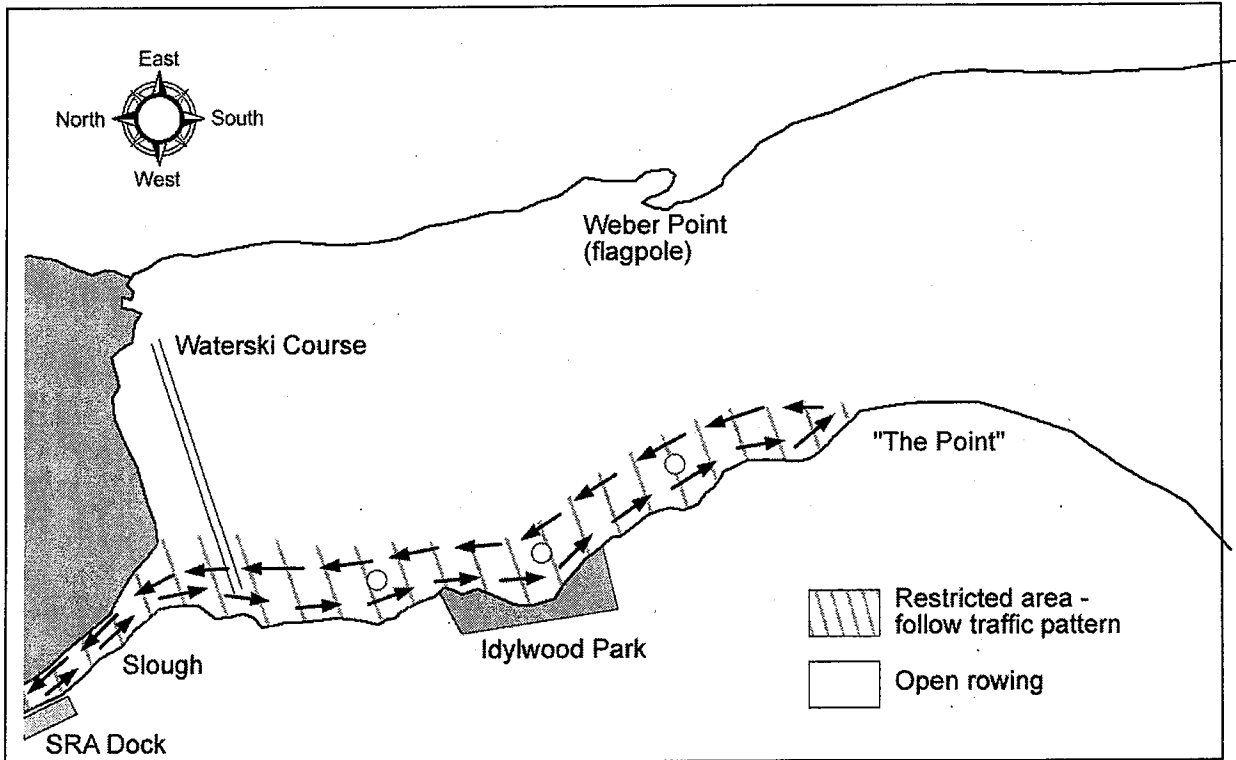
- ☑ Be aware that there are swimmers near Idlywood. Row wide around Idlywood, especially in the summer.
- ☑ Get to shore if you see lightning while rowing. Head to the closest shore and get off the water. If you see distant lightning, head back to the boathouse.
- ☑ Ensure you stay well hydrated and your temperature is regulated. Carry water and drink often. Wear layered clothing and add or remove as needed to keep your body temperate regulated.
- ☑ If you encounter equipment problems while rowing and there is a coach on the water, try to get their attention in order for them to assist you. All coach's launches are equipped with tools for minor boat repairs (nut tightening, duct taping, etc).
- ☑ If you encounter equipment problems and there is no coach on the water, assess the problem and use your best judgment to determine if you can row back to the boathouse or if you will need to go to shore immediately.
- ☑ If you flip on the water and there is a coach on the lake. Blow the whistle in the life vest and wave your arms to get their attention and have them assist you back into your boat (by climbing into the launch first, then your boat). If you are in the beginner level boats, you may attempt to get into the boat on your own.
- ☑ If you flip on the water and there is not a coach on the lake. If you are in a beginner level boat, you may attempt to get into the boat on your own. If you are in an advanced or racer level boat, you need to swim it to shore. If the temperature is very cold, you will need to flip the boat over and climb on top, then swim it to shore.
- ☑ When returning to the slough, follow the same procedure for crossing the ski course.
- ☑ Row at a paddle in the slough staying to the starboard side. You have right of way if there is an outbound boat in the slough at the same time.

#### **Individual Rowers - After the Row**

- ☑ Docking is first come first out. You must wait your turn and should never cut in front of a bigger boat. You may ask for permission to dock first and if granted then you may proceed.
- ☑ Limit dock time to one minute. Quickly put oars on the oar rack, get shoes on, and get the boat off the dock.
- ☑ Bring your boat up from the dock and put it in the slings.
- ☑ Open the boathouse, if it is not already.
- ☑ Wipe the boat down and put lights away if used. Hang the used towel on the drying rack.
- ☑ Put the boat back in the rack where you got it from (very carefully!). If rowing a double, you need to spin the boat first before entering the boathouse.
- ☑ Get your oars off the dock and put them away.
- ☑ Put away the life vest.
- ☑ Sign in to the logbook and enter your return time. Add comments if the boat flipped or anything else unusual happened.

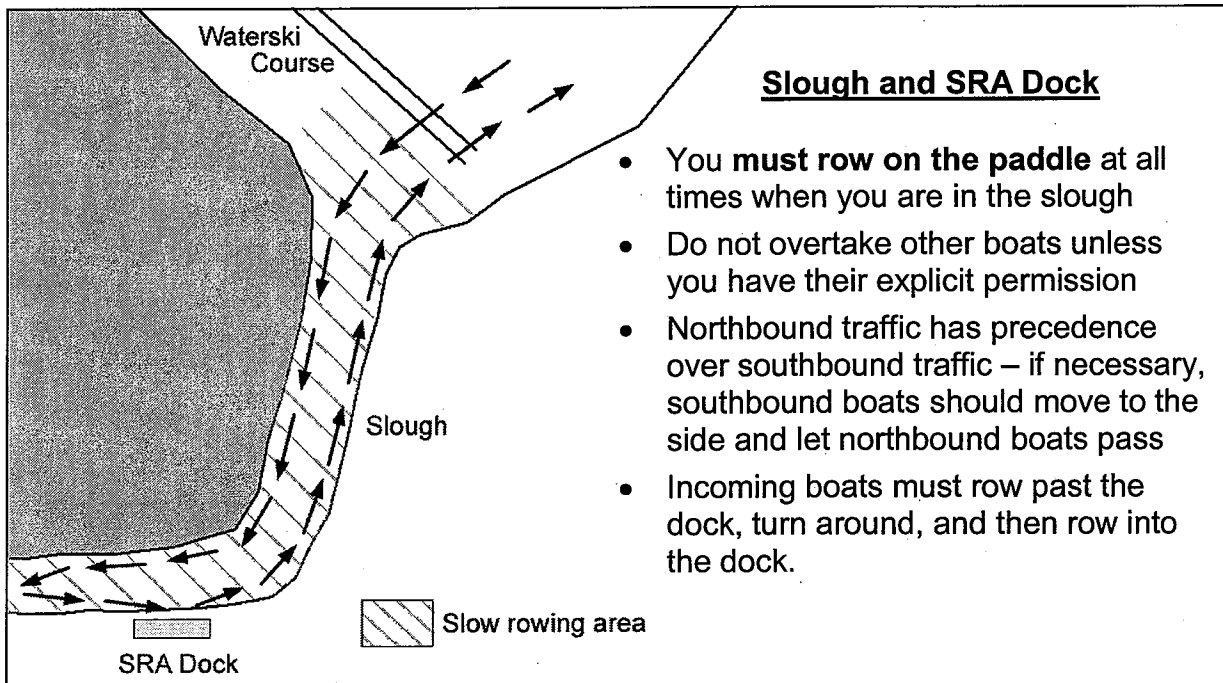
- Report any damage in the Rowers log and in the Equipment log. If the boat is unrowable, put a DO NOT ROW sign on the boat.
- Put your card away.
- Return any launches to the boathouse, if they were taken out to access a shell.
- Consider taking 5 minutes to stretch your muscles.
- Check the dock to see if you left any items on it.
- Throw away trash
- Turn off lights (both inside and outside) and the radio.
- If you are rowing in the evening and are the last person to leave the boathouse and there are no other cars in the parking lot besides yours, lock the gate.

### 5 Appendix B: Lake Sammamish Rowing Traffic Patterns



#### West side of lake between Waterski Course and "The Point"

- Southbound boats: Stay inside the buoys
- Northbound boats: Stay outside the buoys.
- Outside the pattern: Row in the middle of the lake, well clear of the pattern.



#### Slough and SRA Dock

- You **must row on the paddle** at all times when you are in the slough
- Do not overtake other boats unless you have their explicit permission
- Northbound traffic has precedence over southbound traffic – if necessary, southbound boats should move to the side and let northbound boats pass
- Incoming boats must row past the dock, turn around, and then row into the dock.

## Exhibit C: Insurance Requirements and Documentation of Coverage

- A. **FOR ALL COVERAGES.** Each insurance policy shall be written on an "occurrence" form; except that insurance on a "claims made" form may be acceptable with prior County approval. If coverage is approved and purchased on a "claims made" basis, the SRA warrants continuation of coverage, either through policy renewals or the purchase of an extended discovery period, if such extended coverage is available, for not less than three years from the date of Contract termination, and/or conversion from a "claims made" form to an "occurrence" coverage form. By requiring such minimum insurance, the County shall not be deemed or construed to have assessed the risks that may be applicable to the Agency under this Contract.

The SRA shall assess its own risks and, if it deems appropriate and/or prudent, maintain greater limits and/or broader coverage. Nothing contained within these insurance requirements shall be deemed to limit the scope, application and/or limits of the coverage afforded by said policies, which coverage will apply to each insured to the full extent provided by the terms and conditions of the policy(s). Nothing contained within this provision shall affect and/or alter the application of any other provision contained within this Contract.

B. **MINIMUM SCOPE AND LIMITS OF INSURANCE**

Pursuant to the terms of this Contract, for the operations and maintenance of the facility the SRA shall maintain coverage and limits for no less than:

1. **General Liability:**  
Insurance Services Office form number (CG 00 01) covering COMMERCIAL GENERAL LIABILITY \$1 Million combined single limit per occurrence by bodily injury, personal injury, and property damage, and for those policies with aggregate limits, a \$2 Million aggregate limit.
2. **Automobile Liability: If operations require vehicle usage.**  
Insurance Services Office form number (CA 00 01 Ed. 12-90) covering BUSINESS AUTO COVERAGE, symbol 1 "any auto"; or the appropriate coverage provided by symbols 2, 7, 8, or 9. \$1 Million combined single limit per accident for bodily injury and property damage.
3. **Workers' Compensation: If SRA or Sub-contractor has employees**  
Workers' Compensation coverage, as required by the Industrial Insurance Act of the State of Washington, as well as any similar coverage required for this work by applicable federal or "Other States" state law. Statutory requirements of the state of residency.
4. **Stop Gap/Employers Liability: If SRA or sub-contractor has employees**  
Coverage shall be at least as broad as the protection provided by the Workers Compensation policy Part 2 (Employers Liability) or, in states with monopolistic state funds, the protection provided by the "Stop Gap" endorsement to the general liability policy. Limit: \$1 Million

C. **DEDUCTIBLES AND SELF-INSURED RETENTIONS**

Any deductibles or self-insured retentions must be declared to, and approved by, the County. The deductible and/or self-insured retention of the policies shall not apply to the SRA's liability to the County and shall be the sole responsibility of the SRA.

D. **OTHER INSURANCE PROVISIONS**

The insurance policies required in this Contract are to contain, or be endorsed to contain, the following provisions:

1. **Liability Policies Except Professional and Workers' Compensation**
  - a. The County, its officers, officials, employees, and agents are to be covered as additional insureds as respects liability arising out of activities performed by or on behalf of the SRA in connection with this Contract. Such endorsement shall include Products-Completed Operations.
  - b. The SRA's insurance coverage shall be primary insurance as respects the County, its officers, officials, employees, and agents. Any insurance and/or self-insurance maintained by the County, its officers, officials, employees, or agents shall not contribute with the SRA's insurance or benefit the SRA in any way.
  - c. The SRA's insurance shall apply separately to each insured against whom claim is made and/or lawsuit is brought, except with respect to the limits of the insurer's liability.
2. **All Policies**  
Coverage shall not be suspended, voided, canceled, reduced in coverage or in limits, except by the reduction of the applicable aggregate limit by claims paid, until after forty-five (45) days prior written notice has been given to the County.

- E. **ACCEPTABILITY OF INSURERS.** Unless otherwise approved by the County, Insurance is to be placed with insurers with Bests rating of no less than A:VIII, or, if not rated with Bests, with minimum surpluses the equivalent of Bests' surplus size VIII. Professional Liability, Errors, and Omissions insurance may be placed with insurers with a Bests' rating of B+VII. Any exception must be approved by King County. If, at any time, the foregoing policies shall fail to meet all requirements noted herein, or if a company issuing any such policy shall be or become unsatisfactory to the County, the SRA shall, upon notice to that effect from the County, promptly obtain a new policy, and shall submit the same to the County, with appropriate certificates and endorsements, for approval.

- F. **VERIFICATION OF COVERAGE.** The SRA shall furnish the County with certificates of insurance and endorsements required by this Contract. Such certificates and endorsements, and renewals thereof, shall be attached as exhibits to the Contract. The certificates and endorsements for each insurance policy are to be signed by a person authorized by that insurer to bind coverage on its behalf. The certificates and endorsements for each insurance policy are to be on forms approved by the County prior to the commencement of activities associated with the Contract. The County reserves the right to require complete, certified copies of all required insurance policies at any time.

- G. **SUBCONTRACTORS.** The SRA shall include all subcontractors as insureds under its policies or shall furnish separate certificates of insurance and policy endorsements from each subcontractor. Insurance coverages provided by subcontractors as evidence of compliance with the insurance requirements of this Contract shall be subject to all of the requirements stated herein.

## Exhibit D: Facility Revenue Plan

### Sammamish Rowing Association New Rowing Facility Fundraising / Revenue Plan

#### Introduction

Sammamish Rowing's New Rowing Facility has been a multi-year effort that included a very difficult permitting task, since the Rowing Facility is very close to sensitive wetlands. Therefore, we have adopted a phased approach to fundraising. This document shows the fundraising phases for this project. The total cost of the project is \$4.3M.

#### Design and Permitting Phase - \$790K Status: Fundraising completed in 2007

The goal of this phase is to get the project completely designed and permitted, to a "construction-ready" state. We are just now getting to completion of this phase, but the fundraising was completed in 2007. It broke down as follows:

\$190K	Seed funding from King County CPG program
\$400K	Cash contributions from SRA members
\$200K	In-kind professional services donations from SRA members

#### Construction Phase 1 - \$710K Status: Fundraising In Process, Almost Complete

This is the first phase of construction, which is all of the site work for the project, including all disturbances in the wetland buffer. There is a short summer construction window for this work, and we plan on beginning construction in July of this year.

The fundraising breakdown for this phase is:

\$410K	Funding from King County CPG program
\$200K	Cash contributions from SRA members
\$100K	In-kind construction material donations

#### Construction Phase 2 - \$3.1M Status: Fundraising Starting Summer, 2010

The second phase of construction will erect the new building, tear down the old building and perform the wetland mitigation work. Our goal is to complete this phase of construction in 2011.

The fundraising breakdown for this phase is:

\$1.1M	Cash contributions from existing SRA members
\$800K	Cash contributions from new SRA members
\$1.2M	In-kind construction material and professional labor donations

Given the multi-year permitting process for this project, we want to start this round of fundraising when we break ground on construction for Phase 1.

Our approach to fundraising for this phase is:

- **Naming Opportunities.** A key part of this phase is offering naming rights to various parts of the Rowing Facility. We have developed a plan ranging from large opportunities such as naming the boathouse building, naming each of the boat bays, naming the launch carrel to small opportunities such as commemorative bricks. We have naming opportunities that more than cover the entire amount we are trying to raise for this round.
- **Existing SRA Members.** Our existing members have been eagerly anticipating the new Rowing Facility for many years, and we believe we will see a very enthusiastic response when we are finally in the construction phase. Since we have a long history with our existing members, we have developed a per-individual contribution goal chart.
- **New SRA Members.** The Seattle area is the primary rowing location on the West coast, and one of the largest in the country. An interesting fact is that many adult Eastside rowers who have their own boats are rowing out of clubs in Seattle because that is the only option for boat storage. One of the largest clubs in Seattle, the Pocock Center, has 25% of its members living on the Eastside. And Seattle clubs have waiting lists for boat storage. It is almost impossible under any circumstances to get rack space for larger boats such as doubles and quads. We anticipate a large group of these rowers will be eager to contribute to an Eastside boathouse that will have the storage capacity for boats of all sizes.
- **In-kind Donations.** We have already received a plethora of in-kind donations before even starting this phase of fundraising, for example:
  - Roof (both materials and labor)
  - All flooring (materials and labor)
  - Alarm system
  - All upper-story finishing work

We have identified many more in-kind opportunities as well.

#### Ongoing Operations Costs

- The costs of public operations, maintenance, and programming provided by SRA on behalf of King County are covered by using a combination of volunteers, public program fees, membership fees, and annual fundraising and equipment donations. There are no King County Parks tax dollars required for the operations, maintenance, and programming of the boathouse.
- SRA will also pay King County \$6000 a year to cover parking lot maintenance.

**Exhibit E: State Environmental Policy Act (SEPA) – City of Redmond**

TO BE COMPLETED BY APPLICANTCITY OF REDMONDENVIRONMENTAL CHECKLISTPurpose of Checklist:

The State Environmental Policy Act (SEPA), chapter 43.21C RCW, requires all governmental agencies to consider the environmental impacts of a proposal before making decisions. An environmental impact statement (EIS) must be prepared for all proposals with probable significant adverse impacts on the quality of the environment. The purpose of this checklist is to provide information to help you and the City of Redmond identify impacts from your proposal (and to reduce or avoid impacts from the proposal, if it can be done) and to help the agency decide whether an EIS is required.

Instructions for Applicants:

This environmental checklist asks you to describe some basic information about your proposal. Governmental agencies use this checklist to determine whether the environmental impacts of your proposal are significant, requiring preparation of an EIS. Answer the questions briefly, with the most precise information known, or give the best description you can.

You must answer each question accurately and carefully, to the best of your knowledge. In most cases, you should be able to answer the questions from your own observations or project plans without the need to hire experts. If you really do not know the answer, or if a question does not apply to your proposal, write "do not know" or "does not apply". Complete answers to the questions now may avoid unnecessary delays later. If you need more space to write answers attach them and reference.

Some questions ask about governmental regulations, such as zoning, shoreline, and landmark designations. Answer these questions if you can. If you have problems, the City can assist you.

The checklist questions apply to all parts of your proposal, even if you plan to do them over a period of time or on different parcels of land. Attach any additional information that will help describe your proposal or its environmental effects. When you submit this checklist the City may ask you to explain your answers or provide additional information reasonably related to determining if there may be significant adverse impact.

Use of Checklist for Non project Proposals:

Complete this checklist for non-project proposals, even though questions may be answered "does not apply." IN ADDITION, complete the SUPPLEMENTAL SHEET FOR NON PROJECT ACTIONS (part D).

For non-project actions, the references in the checklist to the words "project," "applicant," and "property or site" should be read as "proposal," "proposer," and "affected geographic area," respectively.

Date Received Stamp



TO BE COMPLETED BY APPLICANT**A. BACKGROUND**

1. Name of proposed project, if applicable:

**Sammamish Rowing Association Boathouse**

2. Name of applicant:

**Jennifer Reese / ARC Architects**

3. Address and phone number of applicant and contact person:

**1101 E Pike St. Fl 3  
Seattle WA, 98122  
206-322-3322**

4. Date checklist prepared:

**01/21/08**

5. Agency requesting checklist:

**City of Redmond**

6. Proposed timing or schedule (including phasing, if applicable):

**Phase 1 – Road Construction / Utilities July 2009 – October 2009  
Phase 2 – Building Construction October 20089 – October 2010**

7. Do you have any plans for future additions, expansion, or further activity related to or connected with this proposal?

**No**

8. List any environmental information you know about that has been prepared, or will be prepared, directly related to this proposal.

**Wetland Delineation, Tree Preservation Plan, Wildlife Report, Stormwater Report**

9. Do you know whether applications are pending for governmental approvals of other proposals directly affecting the property covered by your proposal?

If yes, explain.

**No**

TO BE COMPLETED BY APPLICANT

10. List any government approvals or permits that will be needed for your proposal, if known.

**Shoreline Substantial Development Permit, Building Permit, Construction Documents/Civil, Conditional Use permit, Demo Permit.**

11. Give brief, complete description of your proposal, including the proposed uses and the size of the project and site. There are several questions later in this checklist that ask you to describe certain aspects of your proposal. You do not need to repeat those answers on this page. (Lead agencies may modify this form to include additional specific information on project description.)

**The proposed project is a 2 story, VB construction. 12,381 s.f. boathouse including a 516 s.f. deck to house the Sammamish Rowing Association. The building includes a boatbay for boat storage as well as exercise and locker rooms. We will maintain the existing pad of the current boathouse as a corral for launch storage.**

12. Location of the proposal. Give sufficient information for a person to understand the precise location of your proposed project, including a street address, if any, and section, township, and range, if known. If a proposal would occur over a range of area, provide the range or boundaries of the site(s). Provide a legal description, site plan, vicinity map, and topographic map, if reasonably available. While you should submit any plans required by the agency, you are not required to duplicate maps or detailed plans submitted with any permit applications related to this checklist.

**5022 WLK Sammamish Pkwy Redmond, WA**

**Parcel #: 1325059042**

**See Attached Legal Description**

**B. ENVIRONMENTAL ELEMENTS**

**1. EARTH**

- a. General description of the site (circle one): flat, rolling, hilly, steep slopes, mountainous, other \_\_\_\_\_. Describe location and areas on the site that have different topography.

**Relatively flat, with < 0% - 8%**

- b. What is the steepest slope on the site (approximate percent slope)? Describe location and areas of different topography.

**~15% at edge of road / driveway to be addressed through design. Other than that 0% - 8%.**

- c. What general types of soils are found on the site (for example, clay, sand, gravel, peat, mulch)? If you know the classification of agricultural soils, specify them and note any prime farmland.

TO BE COMPLETED BY APPLICANT**Earlmont silt loam, kisap silt loam, sulton silt loam, & Tukwila muck**

- d. Are there surface indications or history of unstable soils in the immediate vicinity? If so, describe.

no

- e. Describe the purpose, type, location and approximate quantities of any filling or grading proposed. Indicate source of fill.

**Grading: Cut: 170 cy Fill: 430 cy fill – onsite suitable native material as determined by a professional geotechnical engineer or imported structural fill.**

**Storm, sewer, water – Cut: 1,100 cy Fill: (backfill / bedding) 1,043 cy (fill material same as stated above.**

**Building: Cut 680 cy for building excavation. Fill: 453 cy of quarry spalls.**

- f. Could erosion occur as a result of clearing, construction, or use? If so, generally describe.

**Erosion and sedimentation measures will be in place during construction to eliminate erosion. The completed project has mitigation included to further prevent erosion.**

- g. About what percentage of the site will be covered with impervious surfaces after project construction (for example, asphalt or buildings)?

**Lot Area – 817,825 s.f.**

**Impervious surface: 62,900 s.f.**

**.07 = 7% of site.**

- h. Proposed measures to reduce or control erosion, or other impacts to the earth, if any.

**Filter Fabric fencing, straw wattles, stabilized construction entrance, catch basin protection**

- i. Does the landfill or excavation involve over 100 cubic yards throughout the lifetime of the project?

Yes

## 2. AIR

- a. What types of emissions to the air would result from the proposal (i.e. dust, automobile, odors, industrial wood smoke) during construction and when the project is completed: If any, generally describe and give approximate quantities if known.

**Construction emissions to the air would include dust generated by construction activities. Vehicles are not permitted to the boathouse after completion. Low VOC products will be used on the building to limit the amount of gases produced.**

TO BE COMPLETED BY APPLICANT

- b. Are there any off-site sources of emissions or odor that may affect your proposal? If so, generally describe.

No

- c. Proposed measures to reduce or control emissions or other impacts to air, if any:

**Low VOC products to be used during construction.**

### 3. WATER

#### a. Surface

- 1) Is there any surface water body on or in the immediate vicinity of the site (including year-round and seasonal streams, saltwater, lakes, ponds, wetlands)? If yes, describe type, location and provide names. If appropriate, state what stream or river it flows into. provide a sketch if not shown on site plans.

**The Sammamish River, the wetlands located on site.**

- 2) Will the project require any work over, in, or adjacent to (within 200 feet) the described waters: If yes, please describe and attach available plans. Note approximate distance between surface waters and any construction, fill, etc..

**Construction of the fire turn and a small fuel storage shed (with secondary containment) will take place within the 200 ft. We will also be maintaining the existing concrete pad and adding a fence so it can be used as a corral for launches.**

- 3) Estimate the amount of fill and dredge material that would be placed in or removed from surface water or wetlands and indicate the area of the site that would be affected. Indicate the source of fill material, if from on site.

**No fill material is to be placed within surface water or wetlands. Likewise no dredging is proposed.**

- 4) Will the proposal require surface water withdrawals or diversions? Give general description, purpose, and approximate quantities if known.

**No. No withdrawals or diversions are proposed.**

- 5) Does the proposal lie within a 100-year floodplain? If so, note location on the site plan.

**The proposal is within the 100 – year flood plain, but it is not within the FEMA floodway.**

TO BE COMPLETED BY APPLICANT

- 6) Does the proposal involve any discharge of waste materials to surface waters? If so, describe the type of waste and anticipated volume of discharge.

**During construction, contractor will be required to implement temporary erosion and sediment control measures to meet water quality requirements for construction storm water runoff. After construction, there will be no discharge of waste materials to surface waters.**

**b. Ground**

- 1) Will ground water be withdrawn, or will water be discharged to ground water? Give general description, purpose, and approximate quantities if known.

No

- 2) Describe waste material that will be discharged into the ground from septic tanks or other sources, if any (for example: Domestic sewage; industrial, containing the following chemicals...; agricultural; etc.) Describe the general size of the system, the number of such systems, the number of houses to be served (if applicable), or the number of animals or humans the system(s) are expected to serve.

**There will be no waste material discharged into the ground.**

**c. Water Runoff (including storm water):**

- 1) Describe the source(s) of runoff (including storm water) and method of collection, transport/conveyance, and disposal, if any (include quantities, if known). Where will this water flow? Will this water flow into other waters? If so, describe.

**Run off will continue to follow existing sheet flow patterns along existing access drive. Runoff from building's downspouts will be tight lined to on-site conveyance system and then daylighted released via pop-up emitters for sheet flow into neighboring vegetation and wetlands. Eventually the water will flow into the Lake Sammamish River.**

- 2) Could waste materials enter ground or surface waters? If so, generally describe.

No

**d. Proposed measures to reduce or control surface, ground, and runoff water impacts, if any:**

**None proposed. Flow control to follow City of Redmond Requirements.**

**4. PLANTS**

- a. Check or circle types of vegetation found on the site:

TO BE COMPLETED BY APPLICANT

- deciduous tree: **alder, maple**, aspen, other – **cottonwood, hawthorn, willow, locust, cherry, chestnut**
- evergreen tree: **fir**, cedar, **pine**, other
- shrubs
- grass
- \_\_\_ pasture
- \_\_\_ crop or grain
- wet soil plants: cattail, buttercup, bulrush, skunk cabbage, other – **pacific willow, red alder, black cottonwood, Oregon ash, sitka willow, scouler willow, weeping willow, pacific crabapple, red-osler dogwood, Douglas spirea, black twin berry, salmon berry, curly dock, canary grass, lady fern**
- water plants: water lily, eelgrass, milfoil, other – **yellow pond-lily and American white waterlily.**
- \_\_\_ other types of vegetation (Please list)

- b. What kind and amount of vegetation will be removed or altered?

**We will meet CoR tree preservation requirements. Several trees including Pacific willow, Oregon Ash, red alder, black cottonwood, weeping willow and big leaf maple are to be removed from the proposed boathouse and along the edge of the access road. The reed canary grass and blackberry dominate in the understory of the location are to be removed.**

- c. List threatened or endangered species known to be on or near the site.  
**Bald eagle – known to be near the subject property.**  
**Pileated Woodpecker – likely forages near or on the subject property.**  
**Please see attached portion of the Wildlife Report for further information.**
- d. Proposed landscaping, use of native plants, or other measures to preserve or enhance vegetation on the site, if any:

**Please see attached list.**

## 5. ANIMALS

- a. Circle any birds and animals which have been observed on or near the site or are known to be on or near the site:

birds:            **hawk, heron, eagle, songbirds**, other:  
mammals:       **deer**, bear, elk, **beaver**, other:  
fish               **salmon, trout**, herring, shellfish, other:

- b. List any threatened or endangered species known to be on or near the site.

**Puget Sound Chinook salmon in river.**

- c. Is the site part of a migration route: If so, explain.

TO BE COMPLETED BY APPLICANT

**It is part of a migration route form migrating birds.  
Adjacent Sammamish is a salmon migratory route.**

- d. Proposed measures to preserve or enhance wildlife, if any:

**Maintaining as much natural habitat-creating and ---natural vegetation through mitigation.**

## 6. ENERGY AND NATURAL RESOURCES

- a. What kinds of energy (electric, natural gas, oil, wood stove, solar) will be used to meet the completed project's energy needs: Describe whether it will be used for heating, manufacturing, etc.

**Electric will be used to power the building. The building has limited heated (radiant panels) and lighting.**

- b. Would your project affect the potential use of solar energy by adjacent properties? If so, generally describe.

**No. The building is located generally in the center of the site.**

- c. What kinds of energy conservation features are included in the plans of this proposal? List other proposed measures to reduce or control energy impacts, if any:

**The building will operate with limited heating to preserve energy. Each room has radiant panels so that only occupied rooms are heated. Passive cooling and heating as well as a highly emissive roof will help regulate the temperature of the building.**

## 7. ENVIRONMENTAL HEALTH

- a. Are there any environmental health hazards, including exposure to toxic chemicals, risk or fire and explosion, spill, or hazardous waste, that could occur as a result of this proposal? If so, describe.

**150 gallons of gas will be stored in a tank and flammable materials locker as an accessory to the proposed bath house. The locker has a concrete basin that will serve as secondary containment.**

- 1) Describe special emergency services that might be required.

**None anticipated**

- 2) Proposed measures to reduce or control environmental health hazards, if any:

**None**

TO BE COMPLETED BY APPLICANT

## b. Noise

- 1) What types of noise exist in the area which may affect your project (for example: traffic equipment, operation, other)?

**None**

- 2) What types and levels of noise would be created by or associated with the project on a short-term or a long-term basis (for example: traffic, construction, operation, other)? Indicate what hours noise would come from the site.

**Short term construction noise – one year. Hours to comply with City of Redmond Standards.**

- 3) Proposed measures to reduce or control noise impacts, if any:

**None**

## c. Describe the potential use of the following:

- 1) Flammable liquids – **150 gallons of gas**
- 2) Combustible liquids – **5 gallons of oil, 1 gallon of fiberglass epoxy resin, 1 gallon of solvent**
- 3) Flammable gases
- 4) Combustible or flammable fibers
- 5) Flammable solids
- 6) Unstable materials
- 7) Corrosives
- 8) Oxidizing materials
- 9) Organic peroxides
- 10) Nitromethane
- 11) Ammonium nitrate
- 12) Highly toxic material
- 13) Poisonous gas
- 14) Smokeless powder
- 15) Black sporting powder
- 16) Ammunition
- 17) Explosives
- 18) Cryogenics
- 19) Medical gas
- 20) Radioactive material
- 21) Biological material
- 22) High piled storage (over 12' in most cases)

**8. LAND AND SHORELINE USE**



TO BE COMPLETED BY APPLICANT

- a. What is the current use of the site and adjacent properties?  
**There is an existing boathouse on the site. Adjacent lands are parklands.**
- b. Has the site been used for agriculture? If so, describe.  
**Not believed to have been agricultural.**
- c. Describe any structures on the site.  
**Boathouse – 40' x 76' – used to store non –motorized boats.**
- d. Will any structures be demolished? If so, what?  
**The existing boathouse will be demolished after the proposed boathouse is built. The existing foundation will remain and will be reused as a corral for the launches.**
- e. What is the current zoning classification of the site?  
**R – 1**
- f. What is the current comprehensive plan designation of the site?  
**The Comprehensive Plans designation is Single Family Constrained.**
- g. If applicable, what is the current shoreline master program designation of the site?  
**The Shoreline designation is Rural.**
- h. Has any part of the site been classified as an "environmentally sensitive" area? If so, specify.  
(If unsure check with City)  
**Wetlands, fish and wildlife habitat conservation area- frequently flooded area.**
- i. Approximately how many people would reside or work in the completed project.  
**None residing, two working full time.**
- j. Approximately how many people would the completed project displace?  
**None**
- k. Proposed measures to avoid or reduce displacement impacts, if any:  
**None**
- l. Proposed measures to ensure the proposal is compatible with existing and projected land uses and plans, if any:

TO BE COMPLETED BY APPLICANT

**Construction Pavement Review**  
**SEPA**  
**Conditional use permit**  
**Shoreline**  
**Building Permit**

m. What percentage of the building will be used for:

- 1) Warehousing – **storage of equipment (crew shells) 4,773 sf**
- 2) Manufacturing
- 3) Office
- 4) Retail
- 5) Service (specify)
- 6) Other (specify) – **Exercise/meeting rooms/Circ. = 7,608 sf**
- 7) Residential

n. What is the proposed U.B.C. construction type?

**IBC - VB**

o. How many square feet are proposed (gross square footage including all floors, mezzanines, etc.)

**12,381 sf boathouse**

**516 sf deck**

p. How many square feet are available for future expansion (gross square footage including floors, mezzanines and additions).

**N/A – there is no plan for expansion**

## 9. HOUSING

a. Approximately how many units would be provided, if any? Indicate whether high, middle, or low-income housing.

**None**

b. Approximately how many units, if any, would be eliminated? Indicate whether high, middle, or low-income housing.

**None**

TO BE COMPLETED BY APPLICANT

- c. Proposed measures to reduce or control housing impacts, if any:  
**N/A – there are no housing units on the site. None would be impacted.**

**10. AESTHETICS**

- a. What is the tallest height of any proposed structure(s), not including antennas; what is the principal exterior building material(s) proposed?

**30 feet, metal panel, poly carbonate.**

- b. What views in the immediate vicinity would be altered or obstructed?

**None**

- c. Proposed measures to reduce or control aesthetic impacts, if any:

**None**

**11. LIGHT AND GLARE**

- a. What type of light or glare will the proposal produce: What time of day or night would it mainly occur:

**No light or glare will occur because of the proposed project. Lighted bollards on path to boathouse are on a timer. Poles are shielded.**

- b. Could light or glare from the finished project be a safety hazard or interfere with views:

**No**

- c. What existing off-site sources of light or glare may affect your proposal?

**None**

- d. Proposed measures to reduce or control light and glare impacts, if any:

**Cut off shields on fixtures. Fixtures set to timers.**

**12. RECREATION**

- a. What designated and informal recreational opportunities are in the immediate vicinity?

**Marymoor park  
Existing boathouse  
Off leash dog park**

- b. Would the proposed project displace any existing recreational uses? If so, describe.

TO BE COMPLETED BY APPLICANT

**No – only expand the opportunities.**

- c. Proposed measures to reduce or control impacts on recreation, including recreation opportunities to be provided by the project or applicant, if any:

**Project will allow for more recreation in the area.**

**13. HISTORIC AND CULTURAL PRESERVATION**

- a. Are there any places or objects listed on, or proposed for, national, state, or local preservation registers known to be on or next to the site? If so, generally describe.

**None known.**

- b. Generally describe any landmarks or evidence of historic, archaeological, scientific, or cultural importance known to be on or next to the site.

**If historic or cultural resources are discovered during construction, work will be ceased and the state Department of Archaeology and Historic Preservation will both be contacted.**

- c. Proposed measures to reduce or control impacts, if any:

**There are no historic or cultural items of importance known on site. If items are located action will be taken as listed above.**

**14. TRANSPORTATION**

- a. Identify public streets and highways service the site, and describe proposed access to the existing street system. Show on site plans, if any.

**West Lake Sammamish Parkway – new channelization plan for the parkway is proposed as well as additional grading at driveway entrance.**

- b. Is site currently served by public transit? If not, what is the approximate distance to the nearest transit stop.

**There is a bus stop along the frontage of the property.**

- c. How many parking spaces would the completed project have: How many would the project eliminate?

**The project would not eliminate any parking. Two ADA spaces will be provided. 40 parking spaces are provided.**

- d. Will the proposal require any new roads or streets, or improvements to existing roads or streets, not including driveways? If so, generally describe (indicate whether public or private).

TO BE COMPLETED BY APPLICANT**Frontage improvements and channelization improvements WLSP.**

- e. How many weekday vehicular trips (one way) per day would be generated by the completed project? 0 No more vehicles would be accessing the site than what is used currently

If known, indicate when peak volumes would occur. **5 - 6 a.m. & 6 - 7 p.m.** How many of these trips occur in the a.m. peak hours? 30 How many of these trips occur in the p.m. peak hours? 100

**Approximately 130 people visit the site per day. The new boathouse will not add to the number of visitors. Users are limited by the size of the dock which won't be increased.**

- f. Proposed measures to reduce or control transportation impacts, if any.

**Added left hand turn lane.**

**15. PUBLIC SERVICES**

- a. Would the project result in an increased need for public services (for example: fire protection, police protection, health care, schools, other)? If so, generally describe.

No

- b. Proposed measures to reduce or control direct impacts on public services, if any.

No

**16. UTILITIES**

- a. Circle utilities currently available at the site: electricity, natural gas, water, refuse service, telephone, sanitary sewer, septic system, other.

**New service utilities for the proposed building will be installed including domestic water, fire services to building and private hydrant, electrical, sanitary sewer, and service drain piping. COR also requires existing overhead electrical and franchise utilities to be rerouted to a direct bury along the project's frontage for the replacement of the existing --- Telephone/cable and data will also be routed to the boathouse.**

- b. Describe the utilities that are proposed for the project, the utility providing the service, and the general construction activities on the site or in the immediate vicinity which might be needed.

**The new building will use existing utilities available at site. New water/fire /sewer lines / power will be run to the building and connect to existing utilities at the intersection of the projects pathway and West Lake Sammamish Parkway.**

TO BE COMPLETED BY APPLICANT

**C. SIGNATURE**

The above answers are true and complete to the best of my knowledge. I understand that the lead agency is relying on them to make its decision.

Signature:  \_\_\_\_\_

Date Submitted:

Relationship to signer to project:

TO BE COMPLETED BY APPLICANT**D. SUPPLEMENTAL SHEET FOR NON-PROJECT ACTIONS**  
***(DO NOT USE THIS SHEET FOR PROJECT ACTIONS)***

Because these questions are very general, it may be helpful to read them in conjunction with the list of the elements of the environment.

When answering these questions, be aware of the extent the proposal or the types of activities likely to result from the proposal, would affect the item at a greater intensity or at a faster rate than if the proposal were not implemented. Respond briefly and in general terms.

1. How would the proposal be likely to increase discharge to water; emissions to air; production, storage, or release of toxic or hazardous substances; or production of noise:

Proposed measures to avoid or reduce such increases are:

2. How would the proposal be likely to affect plants, animals, fish, or marine life?

Proposed measures to protect or conserve plants, animals, fish or marine life are:

3. How would the proposal be likely to deplete energy or natural resources?

Proposed measures to protect or conserve energy and natural resources are:

4. How would the proposal be likely to use or affect environmentally sensitive areas or areas designated (or eligible or under study) for governmental protection; such as parks, wilderness, wild and scenic rivers, threatened or endangered species habitat, historic or cultural sites, wetlands, floodplains, or prime farmlands:

Proposed measures to protect such resources or to avoid or reduce impacts are:

5. How would the proposal be likely to affect land and shoreline use, including whether it would allow or encourage land or shoreline uses incompatible with existing plans?

Proposed measures to avoid or reduce shoreline and land use impacts are:

6. How would the proposal be likely to increase on transportation or public services and utilities?

TO BE COMPLETED BY APPLICANT

Proposed measures to reduce or respond to such demand(s) are:

7. Identify, if possible, whether the proposal may conflict with local, state, or federal laws or requirements for the protection of the environment.



Sammamish Rowing Association Boathouse  
5022 W Lake Sammamish Parkway  
Legal Description:

PARCEL A:

THE SOUTHWESTERLY 150 FEET OF THE FOLLOWING DESCRIBED TRACT:

THE SOUTHEASTERLY 5 ACRES OF THAT CERTAIN TRACT OF LAND IN GOVERNMENT LOTS 5 AND 6 OF SECTION 13, TOWNSHIP 25 NORTH, RANGE 5 EAST, WILLAMETTE MERIDIAN, IN KING COUNTY, WASHINGTON, DESCRIBED AS FOLLOWS:

BEGINNING AT A POINT IN THE CENTERLINE OF COUNTY ROAD FORMERLY KNOWN AS COTTERILL ROAD, 442.5 FEET NORTH AND 947 FEET EAST OF THE QUARTER CORNER BETWEEN SECTIONS 13 AND 14; THENCE NORTHWESTERLY ALONG THE CENTERLINE OF SAID ROAD TO A POINT WHICH IS 873 FEET NORTH AND 697 FEET EAST OF SAID QUARTER CORNER; THENCE NORTH 58°20' EAST 859 FEET, MORE OR LESS TO A POINT ON THE LEFT BANK OF THE SAMMAMISH RIVER WHICH IS 1,324.00 FEET NORTH AND 1,428 FEET EAST OF SAID QUARTER CORNER; THENCE SOUTHEASTERLY ALONG THE LEFT BANK OF SAID RIVER TO A POINT 659.5 FEET NORTH AND 1,915 FEET EAST OF SAID QUARTER CORNER; THENCE SOUTH 77°22' WEST 992, MORE OR LESS, TO THE POINT OF BEGINNING; ( THE NORTHERLY BOUNDARY OF SAID 5 ACRES BEING A LINE PARALLEL TO THE SOUTHEASTERLY BOUNDARY OF SAID DESCRIBED TRACT); EXCEPT THAT PORTION THEREOF LYING WITHIN COUNTY ROAD RIGHT OF WAY.

PARCEL B:

COMMENCING AT THE SOUTHWEST CORNER OF THE NORTHWEST QUARTER OF SECTION 13, TOWNSHIP 25 NORTH, RANGE 5 EAST, W.M., IN KING COUNTY, WASHINGTON;

THENCE SOUTH 89°00'41" EAST ALONG THE SOUTH LINE OF SAID NORTHWEST QUARTER A DISTANCE OF 947.00 FEET; THENCE NORTH 01°26'39" EAST 442.50 FEET TO A POINT ON THE CENTERLINE OF WEST SAMMAMISH ROAD; THENCE NORTH 78°18'28" EAST A DISTANCE OF 30.80 FEET TO A POINT ON THE EASTERLY RIGHT-OF-WAY OF WEST SAMMAMISH ROAD AND THE TRUE POINT OF BEGINNING; SAID POINT BEING ON A CURVE TO THE LEFT HAVING A RADIUS OF 2165.44 FEET A RADIAL LINE THROUGH SAID POINT BEARS NORTH 65°19'34" EAST; THENCE ALONG THE ARC OF SAID CURVE AND EASTERLY RIGHT-OF-WAY PASSING THROUGH A CENTRAL ANGLE OF 063°11'13" AN ARC DISTANCE OF 233.83 FEET; THENCE NORTH 78°18'28" EAST 158.19 FEET TO A POINT ON A CURVE TO THE RIGHT HAVING A RADIUS OF 2315.44 FEET; THENCE SOUTH 78°18'28" WEST 153.67 FEET TO THE TRUE POINT OF BEGINNING;

EXCEPT THAT PORTION THEREOF LYING WITHIN THE ABOVE PARCEL A.

d. Proposed landscaping, use of native plants, or other measures to preserve or enhance vegetation on the site, if any:

Extensive native planting is proposed for currently degraded wetland and buffer areas on- and off-site. Mitigation for buffer and wetland "paper-fill" impacts proposed will include 16.83-acres of wetland enhancement, 0.36-acres of buffer enhancement and 1.68 acres of wetland reestablishment (A final mitigation plan detailing proposed mitigation will be available soon). All told, over 18 acres of land will be planted with native vegetation selected to improve wildlife habitat and water quality functions. On the subject parcel, two acres of degraded wetland and degraded buffer will be densely planted as a part of the proposed mitigation. The extensive planting will help to offset the loss of trees due to boathouse and utility construction.

The following is a sample of the plants to be used in the planting areas:

- Red Alder (*Alnus rubra*)
- Oregon ash (*Fraxinus latifolia*)
- Sitka spruce (*Picea sitchensis*)
- Western red cedar (*Thuja plicata*)
- Black cottonwood (*Populus balsamifera*)
- Pacific willow (*Salix lucida*)
- Sitka willow (*Salix sitchensis*)
- Red-osier dogwood (*Cornus sericea*)
- Black twinberry (*Lonicera involucrata*)
- Mock orange (*Philadelphus lewisii*)
- Pacific ninebark (*Physocarpus capitatus*)
- Sword fern (*Polystichum munitum*)
- Nootka rose (*Rosa nutkana*)
- Cluster rose (*Rosa pisocarpa*)
- Salmonberry (*Rubus spectabilis*)
- Douglas spirea (*Spiraea douglasii*)
- Snowberry (*Symphoricarpos albus*)

## 4. PLANTS (C.)

or open water meet forest. However, edges can also promote invasion by pest species into adjoining habitat, particularly where they occur near urban areas. Nest depredation and brood parasitism are also generally high in edge habitat. Creation of edge in urban areas is usually considered more harmful than beneficial to wildlife.

Expected species richness in the study area is high, based on the diversity of habitats, including the species-rich riparian, wetland, and edge habitat types. Species are likely to be diverse as well, as habitat for reptiles, amphibians, mammals, and birds is present. Proximity of edges to urban habitat suggests pest species are present.

### Landscape Level Habitat Functions

The study area has unique attributes because of its position in the greater landscape. It is adjacent to Marymoor Park and County-owned lands that are not densely developed. It is also within 0.5 miles of Lake Sammamish. The vicinity, as a whole, however, is urban, and specifically densely developed residential. As a general rule, species diversity decreases and species densities increase as urbanization increases (Johnson and O'Neil 2001). Density increases are largely the result of exotic species thriving in urban areas.

The study area and surrounding open space together form a relatively large urban refuge. Natural open spaces are crucial for wildlife in urban environments. Generally, the larger the habitat fragment in an urban area, the greater species richness it supports (Johnson and O'Neil 2001). Important elements of urban open spaces include intact patches of native vegetation, natural corridors between habitat blocks, minimizing edges that border development, habitat blocks large enough to maintain ecological functions, and allowing for public access that does not require roads. The study area includes a number of these characteristics. Blocks of mostly native vegetation exist; there is connectivity among habitat types, although the site is roughly split by a gravel road; public access is via the gravel road, but the road is rarely used by vehicles; perhaps most significantly, the study area links to open space to the north and south, and protects a riparian zone leading to a large wetland at the north end of Lake Sammamish, as well as the lake itself.

The study area lacks in habitat value in a few respects. Primarily, invasive vegetation limits habitat function not only in the area where it dominates, but where it occurs within more native vegetative communities. The existing development, including the boathouse, parking lots, and gravel road, also detract from habitat value in that they fragment the remaining natural areas and allow vehicles to enter the site.

### Fish and Species of Local Importance

The City of Redmond designates species of local importance and their associated habitat as Fish and Wildlife Species and Habitat Conservation Areas (RCDC 20D.140.20). Priority species and habitats that occur on or within 1.0 mile of to the study site are bald eagle and purple martin nesting sites, anadromous and resident priority fish species, urban natural open space, and priority wetlands (WDFW 2008). All wildlife species identified on the property during our March 2008 site visit are listed in Table.1.

WDFW (2008) PHS data indicate the presence of both resident and anadromous resident fish in the Sammamish River and Lake Sammamish. Species may include Chinook, coho and sockeye salmon, kokanee, steelhead, bull trout, cutthroat and rainbow trout, and largemouth bass

PHS 2008 data show the closest bald eagle nest to be approximately 0.75 mile east of the study area, on the far side of the Sammamish River. Nearby landowners informed Watershed Company biologists that this nest, last confirmed as active in 2005, had blown down. Conversations with biologists at Puget Sound Bird Observatory confirmed that birders noted construction of a new nest about 0.5 mile west of the old nest in autumn 2005. A pair of bald eagles has been reportedly breeding in this newer nest since its construction. Watershed Company biologists located the nest on 7 April 2008. They were unable to determine whether the birds were in the nest at the time because of poor visibility to the nest.

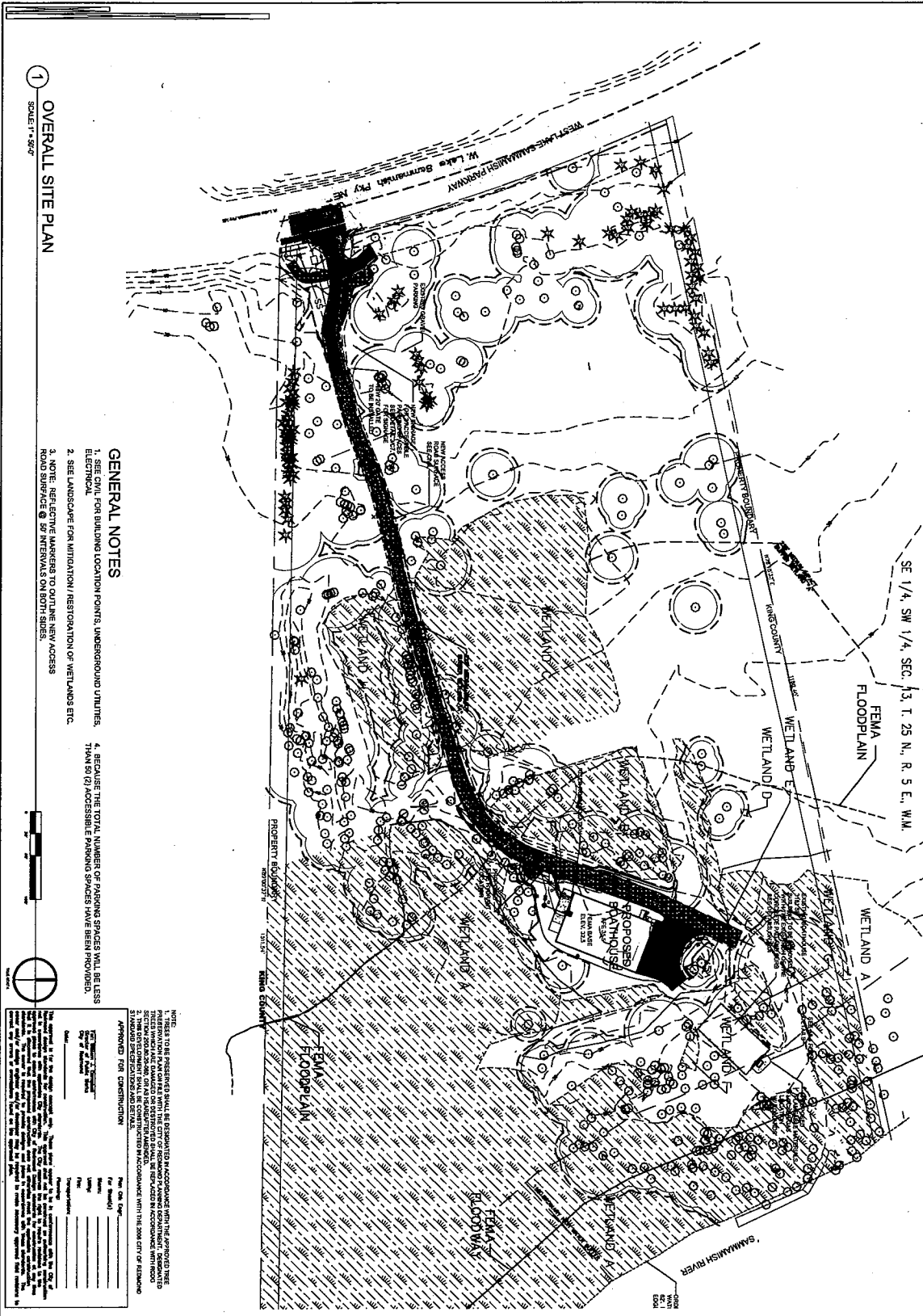
Purple martins nested in pilings at the north end of Lake Sammamish, approximately 0.8 mile from the study area, until at least 2003 (WDFW 2008). No breeding birds were reported in 2004, although individuals have been observed in Marymoor Park in recent years.

Great blue heron is not only a PHS species, but also a species of local importance per City of Redmond (RCDC 20D.140.20-010). A great blue heron colony is located approximately 1.5 miles north of the property. This colony was active from at least 1997 until 2004, when young hatched but the colony was depredated by bald eagles (City of Redmond 2004).

Red-tailed hawks nest in large trees, similar to those on and around the study property, and although no active nests are known, some on-site trees are suitable for the species. Red-tailed hawks are ubiquitous in western Washington almost certainly perch on trees in or fly over the property. Preferred foraging areas have open spaces or road right-of-ways (Seattle Audubon Society 2005), so the most suitable foraging perches in the project vicinity are adjacent to the open meadow. The open grass field provides foraging opportunities.

Like the red-tailed hawk, the osprey may use large trees for perching and nesting. Ospreys typically live near rivers and other large bodies of fresh or salt water. They forage for fish in waters that can support medium-sized fish. The nearby lake and the river provide highly suitable osprey habitat.

The merlin is a rare breeder in western Washington (Seattle Audubon Society 2005). However, wintering and migrating individuals commonly use parks, lakes, urban and suburban areas, and coastal regions, and rely less on forest. This species may use the subject property for perching or foraging.



1 OVERALL SITE PLAN  
SCALE: 1" = 50'-0"

**GENERAL NOTES**

1. SEE CIVIL FOR BUILDING LOCATION POINTS, UNDERGROUND UTILITIES, ELEVATIONS.
2. SEE LANDSCAPE FOR MITIGATION/ RESTORATION OF WETLANDS ETC.
3. NOTE: REFLECTIVE MARKERS TO OUTLINE NEW ACCESS ROAD SURFACE @ 50' INTERVALS ON BOTH SIDES.
4. BECAUSE THE TOTAL NUMBER OF PARKING SPACES WILL BE LESS THAN 50, POSSIBLE PARKING SPACES HAVE BEEN PROVIDED.

NOTES TO BE PRESERVED SHALL BE SHOWN BY ACCORDANCE WITH THE APPROVED TREE PRESERVATION PLAN AND THE CITY OF REDMOND'S LANDSCAPE DEPARTMENT. DESIGNATED SPECIES SHALL BE MAINTAINED OR REPLANTED IN KIND. THE CITY OF REDMOND'S LANDSCAPE DEPARTMENT SHALL BE NOTIFIED OF ANY REMOVALS AND REPLANTING. THE CITY OF REDMOND'S LANDSCAPE DEPARTMENT SHALL BE NOTIFIED OF ANY REMOVALS AND REPLANTING.

**APPROVED FOR CONSTRUCTION**

Prepared by:	ARC
Checked by:	ARC
Approved by:	ARC
Date:	11/11/2020

**A1.0**

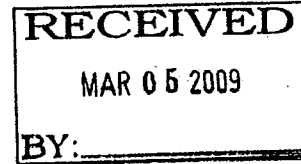
DATE	DESCRIPTION
11/11/2020	ISSUED FOR PERMITTING
11/11/2020	ISSUED FOR CONSTRUCTION

**OVERALL SITE PLAN**

DATE	DESCRIPTION
11/11/2020	ISSUED FOR PERMITTING
11/11/2020	ISSUED FOR CONSTRUCTION

**SRA BOATHOUSE**  
5022 W LK SAMMAMISH PKWY

**ARC**  
ARC ARCHITECTS  
1101 EAST PINE ST  
SOUTH WA 98122  
206 322 5829 FAX  
ARCARCHITECTS.COM



**STATE ENVIRONMENTAL POLICY ACT (SEPA)  
DETERMINATION OF NON-SIGNIFICANCE**

**Name of Proposal/File Number:** SAMMAMISH ROWING ASSOCIATION, File Number L090007

**Description of Proposal:**

THE PROPOSAL INCLUDES A 12,381 SQ.FT. BOATHOUSE INCLUDING A 516 SQ.FT. DECK TO HOUSE THE SAMMAMISH ROWING ASSOCIATION. THE BUILDING INCLUDES A BOAT BAY FOR BOAT STORAGE AS WELL AS EXERCISE AND LOCKER ROOMS. WILL MAINTAIN THE EXISTING PAD OF THE CURRENT BOATHOUSE AS A CORRAL FOR LAUNCH STORAGE.

**Location of Proposal:** SAMMAMISH ROWING ASSOCIATION BOATHOUSE

**Site Address of Proposal (if any):** 5022 W LK SAMMAMISH PKWY RED

**Proponent:** REESE JENNIFER

**Lead Agency:** CITY OF REDMOND

The lead agency for this proposal has determined that the requirements of environmental analysis, protection, and mitigation measures have been adequately addressed through the City's regulations and Comprehensive Plan together with applicable State and Federal laws.

Additionally, the lead agency has determined that the proposal does not have a probable significant adverse impact on the environment as described under SEPA.

An environmental impact statement (EIS) is not required under RCW 43.21C.030(2)(c). This decision was made after review of a completed environmental checklist and other information on file with the lead agency. **This information is available to the public on request.**

(over)

**Comment Period:** Depending upon the proposal, a comment period may not be required. An "X" is placed next to the applicable comment period provision.

There is no comment period for this DNS. Please see below for appeal provisions.

This DNS is issued under 197-11-340(2), and the lead agency will not make a decision on this proposal for 14 days from the date below. Comments can be submitted to the project Planner, Kelsey Larson, at 425-556-2409, via fax at 425-556-2400, via e-mail at [klarson@redmond.gov](mailto:klarson@redmond.gov), or in person at the Development Services Center located at 15670 NE 85th Street, Redmond, WA 98052. **Comments must be submitted by 03/17/2009.**

**Responsible Official:** *Robert G. Odle, Planning Director*

Signature: *Robert G. Odle*

**Responsible Official:** *William J. Campbell, Public Works Director*

Signature: *William J. Campbell*

**Address:** 15670 N.E. 85th Street, P.O. Box 97010, Redmond, WA 98073-9710

**Appeal Period**

You may appeal this determination to the City of Redmond Planning Department, Redmond City Hall, 15670 N.E. 85th Street, P.O. Box 97010, Redmond, WA 98073-9710, **no later than 5:00 p.m. on 04/01/2009**, by submitting a completed City of Redmond Appeal Application Form available on the City's website at [www.redmond.gov](http://www.redmond.gov) or at City Hall. You should be prepared to make specific factual objections.

**For more information about the project or SEPA procedures, please contact the project Planner, Kelsey Larson, at 425-556-2409 or via e-mail [klarson@redmond.gov](mailto:klarson@redmond.gov).**

**Date of DNS issuance: 03/03/2009**

**BEFORE THE HEARING EXAMINER FOR THE CITY OF REDMOND**

**IN THE MATTER OF APPEAL OF )  
BARBARA J. DICKSON OF A SEPA )  
THRESHOLD DETERMINATION FOR )  
THE SAMMAMISH BOATHOUSE )  
REPLACEMENT )**

**FILE NO: L040252**

**FINDINGS OF FACT,  
CONCLUSIONS OF LAW  
AND DECISION**

**DECISION**

The appeal of the threshold determination for the Sammamish Boathouse Replacement proposal is **DENIED**.

**INTRODUCTION**

The appeal of Barbara J. Dickson of the threshold determination for the Sammamish Boathouse Replacement proposal came on for hearing before Gordon F. Crandall, Hearing Examiner, on September 29, 2004 at 10:00AM. Cathy Beam, AICP, Principal Environmental Planner presented the Technical Committee Report.

Testifying under oath were:

- Cathy Beam, Senior Environmental Planner
- Judd Black, Developmental Review Manager
- Barbara J. Dickson, Appellant
- Steve Isaac, Board President of Sammamish Rowing Association

The following exhibits were offered and admitted:

- Exhibit A: Technical Committee Report Dated September 14, 2004
- Exhibit B-1: Statement from Appellant
- Exhibit B-2: Letters Signed by Neighbors Submitted by Appellant
- Exhibit B-3: Friends of Marymoor Park 5/28/03 Meeting Summary



- 1 Exhibit B-4: Coaches List of SRA from Website  
2 Exhibit B-5: Employment Opportunities at SRA from their Website  
3 Exhibit B-6: List of SRA Class Descriptions from their Website  
4 Exhibit B-7: SRA Newsletter from their Website  
5 Exhibit B-8 Photos Submitted by Appellant of Current Overall Environmental Impacts  
6

7 The hearing adjourned approximately at 11:30AM.  
8

9 From the foregoing, the Hearing Examiner makes the following:  
10

11 **FINDINGS OF FACT**

- 12 1. On May 13, 2004 an application for a substantial development permit to replace the existing  
13 boathouse at 5022 West Lake Sammamish Parkway NE with a larger boathouse was submitted  
14 to the City of Redmond by Steve Isaac of the Sammamish Rowing Association (SRA) and  
15 David Sizemore of King County Parks. Notice of the application was posted and mailed to  
16 property owners within 500 feet of the site, with June 1, 2004 as the deadline for public  
17 comments on this application.  
18
- 19 2. On July 12, 2004 the City of Redmond issued a Determination of Non-Significance (DNS) for the  
20 proposal, pursuant to the requirements of the State Environmental Policy Act (SEPA). Comments  
21 on the proposed DNS were received during the SEPA comment period which ended on July 26,  
22 2004. An appeal of the DNS was filed by Barbara J. Dickson on July 23, 2004.  
23
- 24 3. In her appeal, Dickson contends that the project will have damaging effects on the environment  
25 by increasing activity at the site. It was her position that the DNS was based upon  
26 misleading and/or insufficient information. An active sport/club is an inappropriate use in  
27 this area, she said, which should be used only for passive recreation which would protect  
28 residential neighborhoods from excessive traffic and noise.  
29
- 30 4. Her specific reasons are summarized as follows:

- 1 • The boathouse generates noise and lights in a natural area from 5:00AM to 9PM daily
- 2 • The checklist failed to mention trailers and motorboats at the site
- 3 • Many plants and animals found at the site were not mentioned
- 4 • The prior use of the site was for farms and pasture
- 5 • Swimming and bird watching and casual walking at the dock are being displaced by
- 6 the SRA
- 7 • There are more than the two full-time employees mentioned at the site
- 8 • The noise at the site is extreme when 90 youth are present with music for exercise
- 9 classes and from four motorboats
- 10 • There was no mention of gasoline containers at the site, and no way for emergency
- 11 vehicles to access the site
- 12 • There is illegal off-road use of the site and electric lights just hang from trees,
- 13 • Car lights from 5AM to 9PM disturb the neighbors and wildlife
- 14 • More active recreational use is inappropriate in an area designated for conservation in
- 15 Marymoor Park
- 16 • The peak vehicular use of the site creates a 'high school' atmosphere in the afternoon
- 17 • Utilities may have been brought to the site without proper authority
- 18 • Storage of boats outside the boathouse and on the apron was not mentioned
- 19 • There was no mention of the 100 yards of fill needed for the boathouse base on the
- 20 wetlands
- 21 • There was no mention of the asphalt boat ramp leading into the water or of outdoor
- 22 lighting
- 23 • The notice of the appeal opportunity was confusing

24

25 5. The City responded to the appellant's reasons why the DNS should be reversed as

26 follows:

- 27 • There is a boathouse on the site now, and the application is to replace it with a larger
  - 28 facility that better meets the needs of its users
- 29
- 30

- 1 • The proposal is consistent with the Redmond Comprehensive Plan, zoning and
- 2 shoreline management program. The owner of the land could create a 19 lot
- 3 subdivision on the site.
- 4 • Impacts of the proposal will be addressed through development regulations during the
- 5 site entitlement process. There is no need to exercise the City's substantive SEPA
- 6 authority by issuing a mitigated DNS, with conditions.
- 7 • The City has no jurisdiction or duty to enforce the counties master plan for Marymoor
- 8 Park
- 9 • As the proposed use is the same as the current use, there is no lack of information as
- 10 to the environmental impact
- 11 • Plants and animals at this site were discussed in a biological resource technical
- 12 memorandum for the former Lake Hills site clean-up
- 13 • The City relies on appellant to identify the number of employees at the site
- 14 • Noise from the site must not exceed the limits of the City's noise ordinance
- 15 • Hazardous materials were disclosed in the check list
- 16 • Emergency vehicles can access the site, and the Fire Department will impose
- 17 conditions on the permit to ensure that minimum standards are observed
- 18 • Outdoor lighting is necessary at the site. Electrical codes must be observed.
- 19 • The City does not anticipate a dramatic increase in traffic
- 20 • The utilities on the site were disclosed in the checklist
- 21 • The boathouse will not be located in a wetland

22  
23 The City contends that it had adequate information to make the threshold determination  
24 that the proposal did not have a probable significant adverse impact on the environment  
25 as described in SEPA. Accordingly, an EIS was not required.

- 26  
27 6. The property is zoned R-1, and a boathouse as proposed is a permitted use in the zone.
- 28  
29 7. The proposal will increase the area of the building from 3,000 sq.ft. to 4,800 sq.ft, an  
30 increase of 1,800 sq.ft.

1 8. The existing boathouse was constructed in 1977-80, and used at first for seasonal activity.  
2 Now, the use of the boathouse is year round.

3  
4 9. The SRA is a community association open to the public. Annual dues are \$250.00 per  
5 year, but the public may attend classes in rowing, etc, by merely paying the tuition for the  
6 class. The boathouse is located in a public park.

7  
8 10. Appellant lives at 5023 West Lake Sammamish Parkway NE, directly across from the  
9 parking lot for the boathouse and dock. The boathouse building itself is located several  
10 hundred feet from the road in a wild and unimproved wetland area. The parking lot will  
11 be improved as part of the proposal. The road for the parking lot to the boathouse is  
12 closed to traffic by bollards that are not locked. Emergency vehicles and persons seeking  
13 to launch a boat may remove the bollards to access the waters edge. The dock will not be  
14 changed as part of the proposal.

15  
16 11. The permits for the proposal have yet to be issued, with appropriate conditions to  
17 implement the City's codes and to protect the environment.

18  
19 12. Any conclusion of law deemed to be a finding of fact is hereby adopted as such.  
20

21 From these findings of fact the Hearing Examiner makes the following:  
22

23  
24 **CONCLUSIONS OF LAW**

25 1. An appeal of a Determination of Non-Significance (DNS) is a Type II land use decision  
26 heard by the Hearing Examiner. RCDG 20F.30.35-010. The Hearing Examiner has  
27 jurisdiction to hear and decide the appeal.

28  
29 2. The State Environmental Policy Act (SEPA) requires that a public agency shall make a  
30 threshold determination for any proposal which is an 'action' as defined in

1 WAC 197-11-704. "Action" includes a decision to issue a permit for a specific project  
2 that will directly modify the environment. WAC 197-11-704.

- 3
- 4 3. A threshold determination is a determination whether a proposed action requires an EIS.  
5 An EIS is required for proposals which significantly affect the quality of the  
6 environment. In making this determination the Director of Planning and Director of  
7 Public Works are required to review the environmental checklist and any other  
8 information available to them. WAC 197-11-330. If the decision maker concludes that  
9 there is insufficient information to make the threshold determination, they may require  
10 the applicant to submit more information on the subjects of the checklist, make their own  
11 further study, or consult with other agencies. WAC 197-11-335.
- 12
- 13 4. If the Director of Planning and Director of Public Works determine that there will be no  
14 probable significant adverse environmental impacts from the proposal, they shall issue a  
15 DNS. WAC 197-11-340. A City which is planning under the Growth Management Act  
16 (GMA) may use a single integrated comment period to obtain comments on the notice of  
17 application and the likely environmental impacts of the proposal. When this process is  
18 used a second comment period after the DNS is issued will typically not be required. The  
19 City must advise the public in such case that there will be only one opportunity to  
20 comment on the environmental impact of the proposal. WAC 197-11-355. Redmond is  
21 planning under the GMA.
- 22
- 23 5. WAC 197-11-158 provides that in reviewing the environmental impact of a project and  
24 making a threshold determination, a GMA city may, at it's option, determine that the  
25 requirements for environmental analysis, protection and mitigation measures in the City's  
26 development regulations and Comprehensive Plan and in other local, state or federal laws  
27 or rules provide adequate analysis of and mitigation for some or all of the specific  
28 adverse environmental impacts of the project. Redmond has chosen this option in this  
29 case, and a statement to that effect is found on the face of the DNS.
- 30

1 6. The fundamental question in a threshold determination is whether there is reasonable  
2 probability that the proposal will have more than a moderate effect on the quality of the  
3 environment. *Moss vs. City of Bellingham* 100 Wn.App 6, (2001).

4  
5 7. The Examiner is convinced that the Planning Director and Public Works Director had  
6 sufficient information to evaluate the probable adverse environmental impacts of the  
7 proposal. In addition, they determined that the environmental analysis had been  
8 adequately considered through the City's development regulations. Under these  
9 circumstances, an EIS was not required for the proposal. Ms. Dickson's appeal of the  
10 DNS for the Sammamish Boathouse Replacement proposal should be denied. The  
11 substance of her appeal is entitled to be considered, however, during the site entitlement  
12 process and when fashioning the conditions to be imposed on the substantial development  
13 permit.

14  
15 8. Any finding of fact deemed to be a conclusion of law is adopted as such.

16  
17 **DECISION**

18 The appeal of Barbara J. Dickson of the DNS for the Sammamish Boathouse Replacement proposal is  
19 **DENIED.**

20  
21 Done this 13th Day of October 2004.

22  
23 /s/ Gordon F. Crandall

24  
25 \_\_\_\_\_  
26 **GORDON F. CRANDALL**  
27 **HEARING EXAMINER**

**PROCEDURE FOR RECONSIDERATION**

Any interested person (party of record) may file a written request for reconsideration with the Hearing Examiner. The request for reconsideration shall explicitly set forth alleged errors of procedure or fact. The final date for motion for reconsideration is **5:00 P.M. on October 27, 2004**, and should be sent to the **Office of the Hearing Examiner**, City of Redmond, MS: PSFHE, 8701 160<sup>th</sup> Avenue N.E., PO Box 97010, Redmond, Washington, 98073-9710.

**NOTICE OF RIGHT OF APPEAL**

You are hereby notified that the foregoing Findings of Fact, Conclusions, and Decision are the final action on this application subject to the right of appeal to the Redmond City Council. Appeal procedures are governed by RCDG 20F.30.40-110 (Ordinance 2118) to which the reader is referred for detailed instructions. The written appeal must be received by the **Redmond Permit Center** no later than **5:00 P.M. on October 27, 2004, or within 10 business days following final action by the Hearing Examiner if a request for reconsideration is filed.** Please include the application number on any correspondence regarding this case.

The following statement is provided pursuant to RCW 36.70B.130: "Affected property owners may request a change in valuation for property tax purposes notwithstanding any program of revaluation."